

Lillian 34 4X3

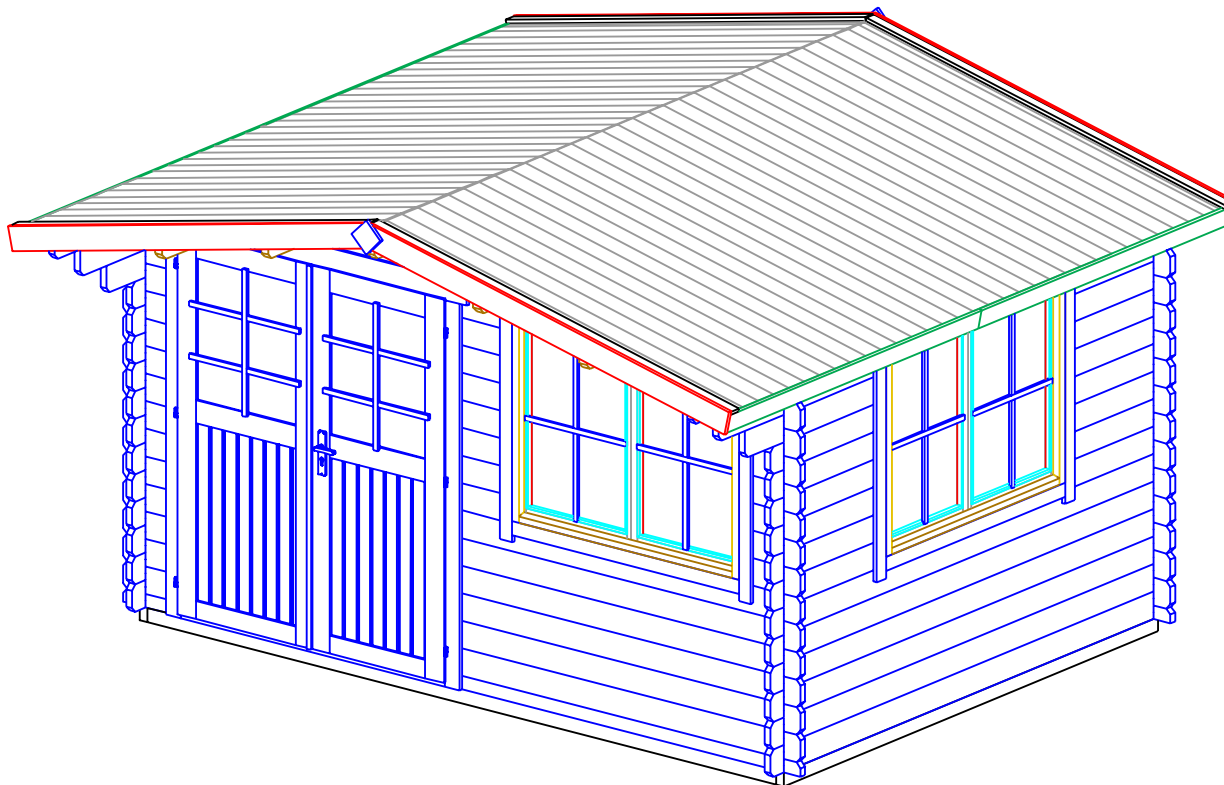

Lillian 34 4X3

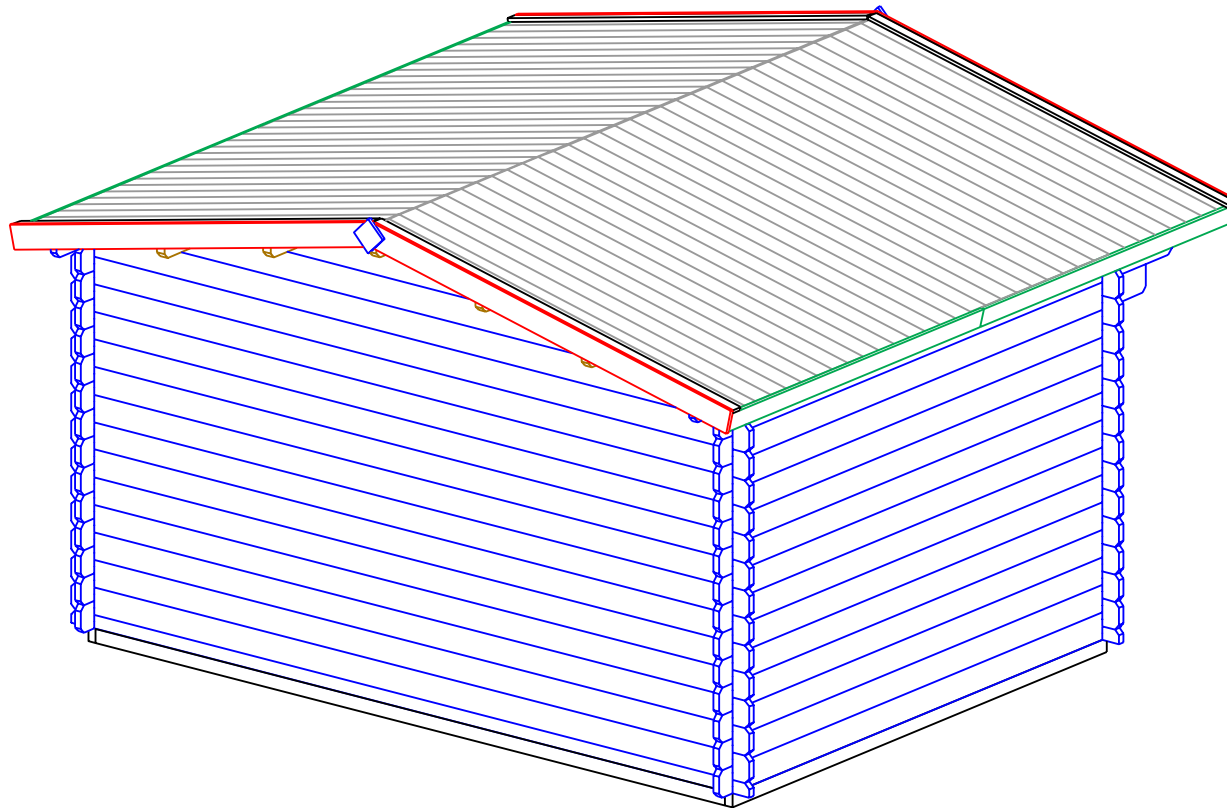

STAGE 1

Lillian 34 4X3

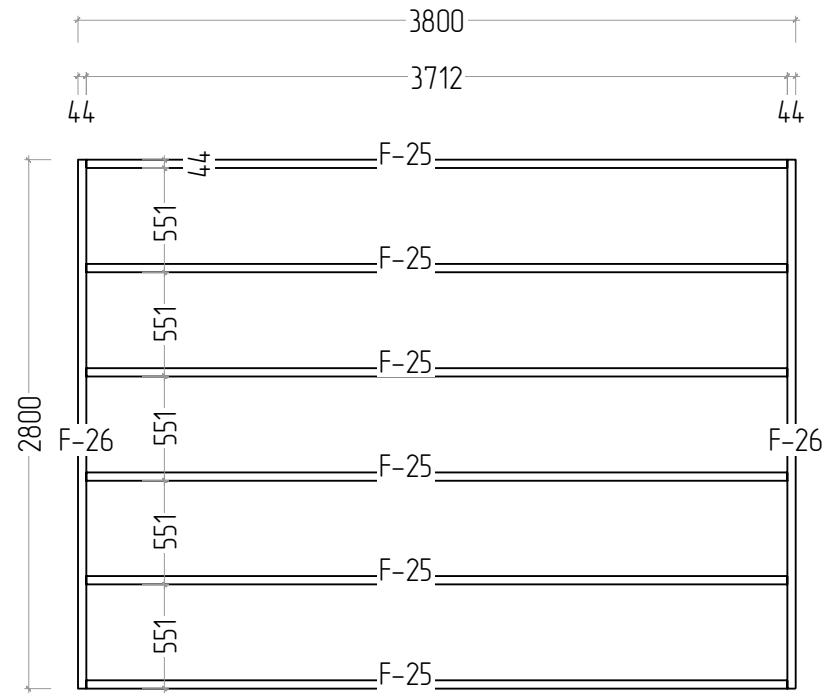

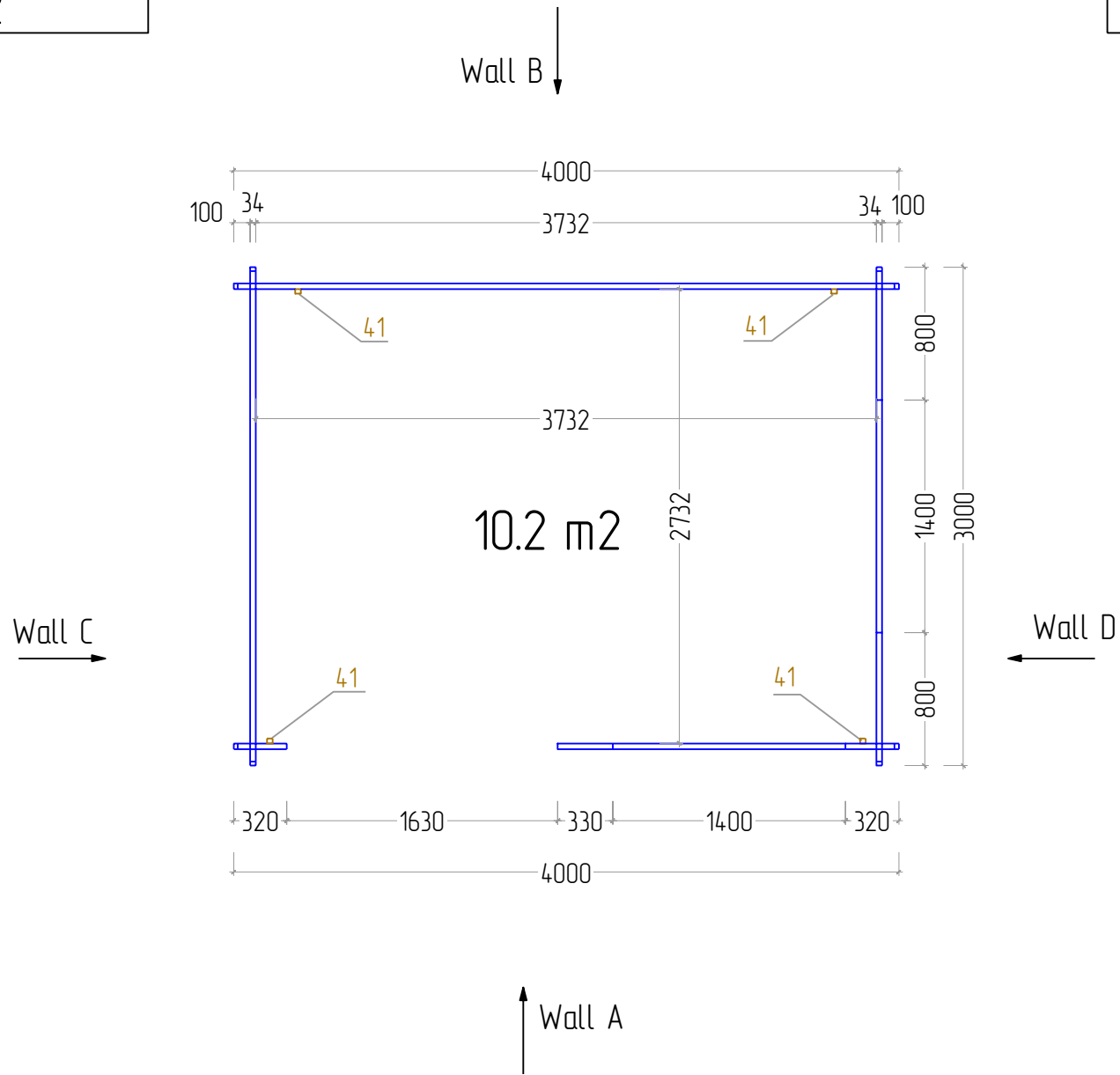

W-A

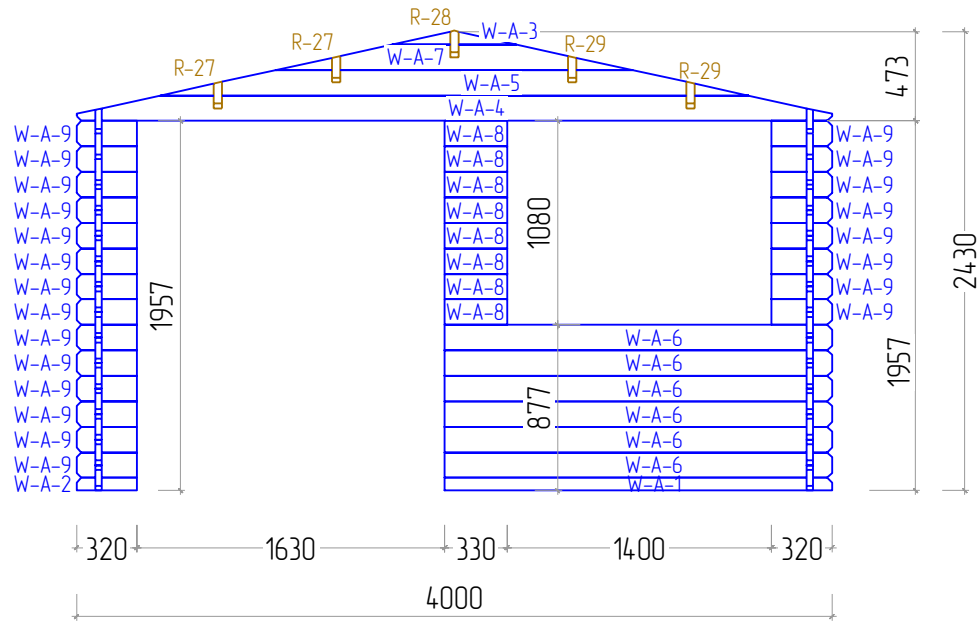

W-B

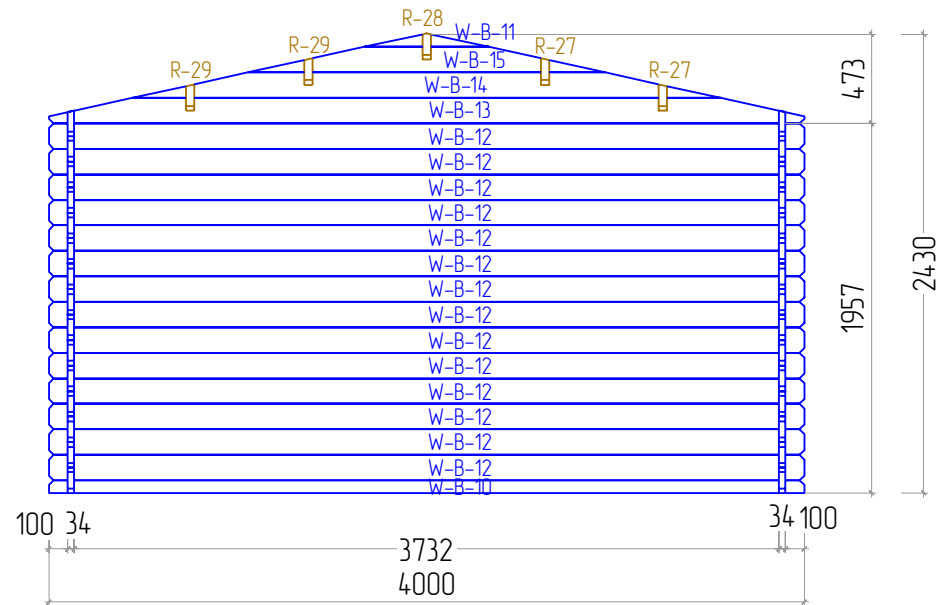

W-C

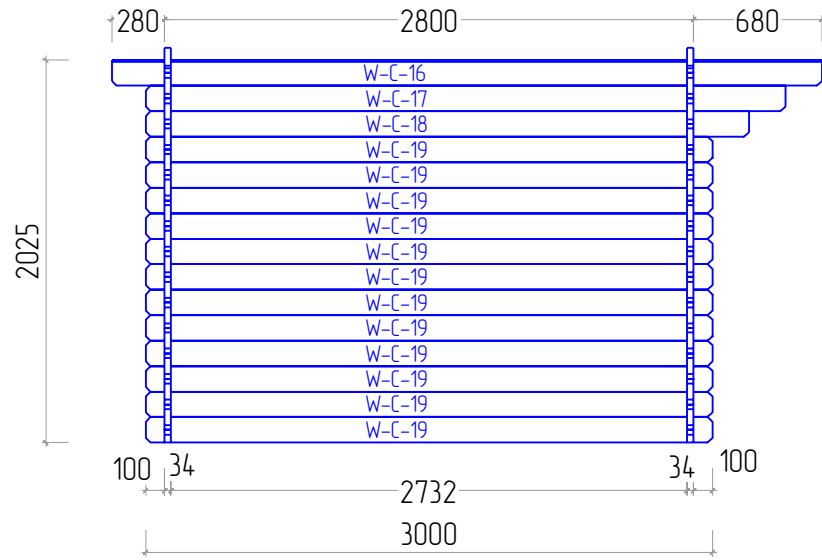

W-D

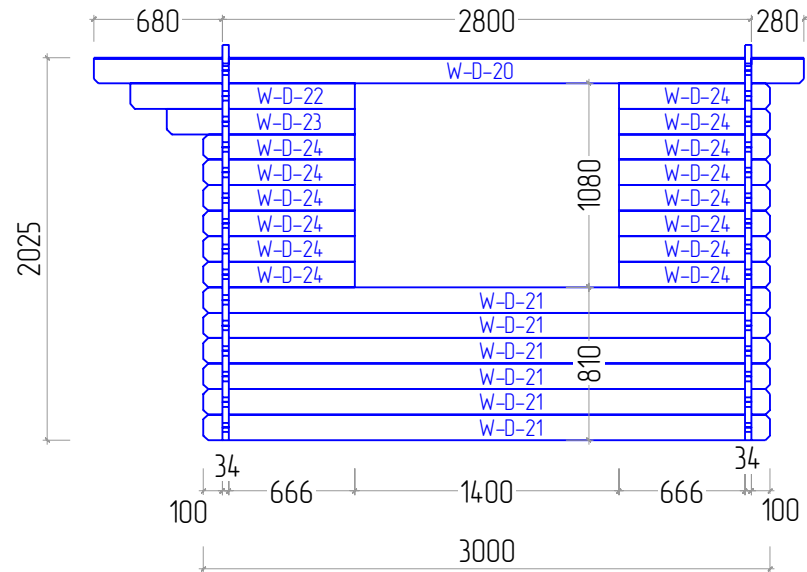

STAGE 3

Lillian 34 4X3

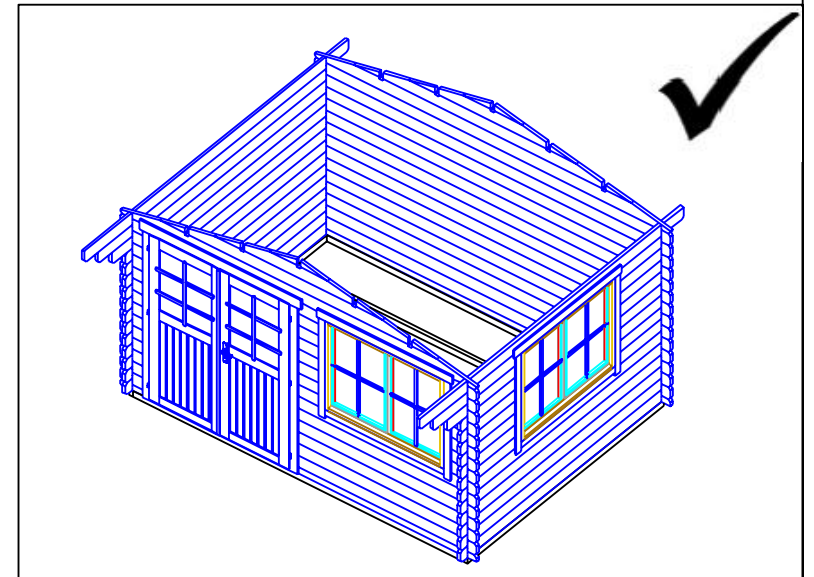
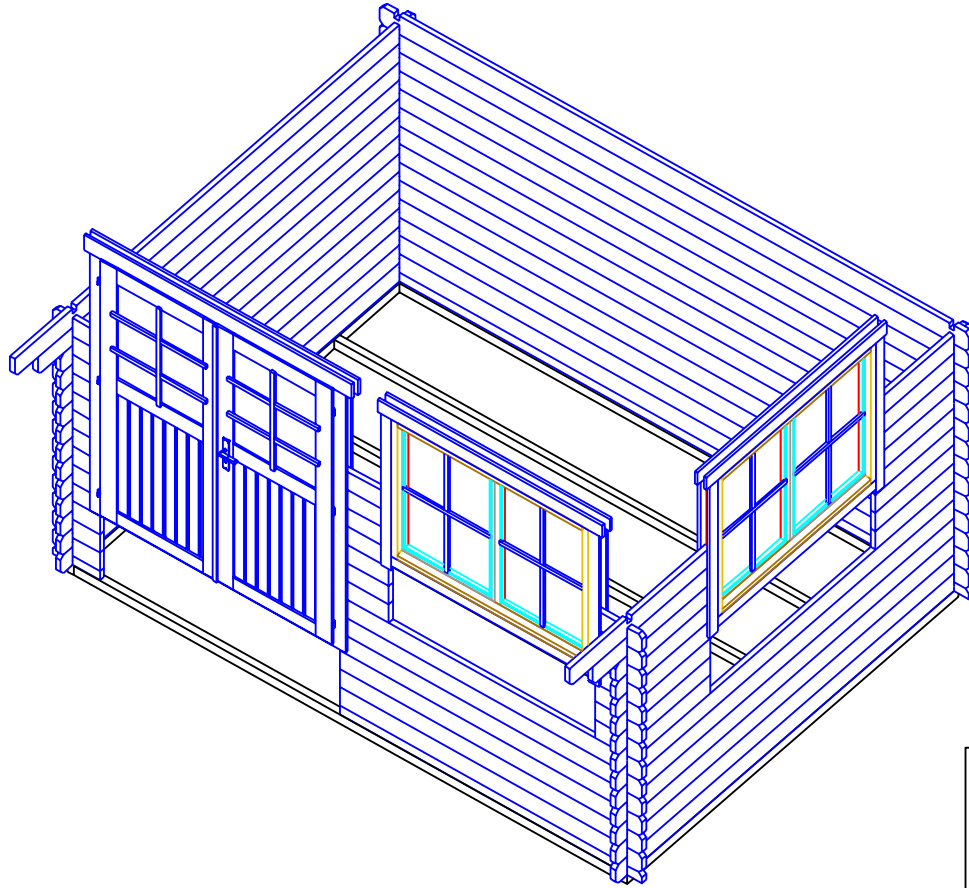

STAGE 4

Lillian 34 4X3

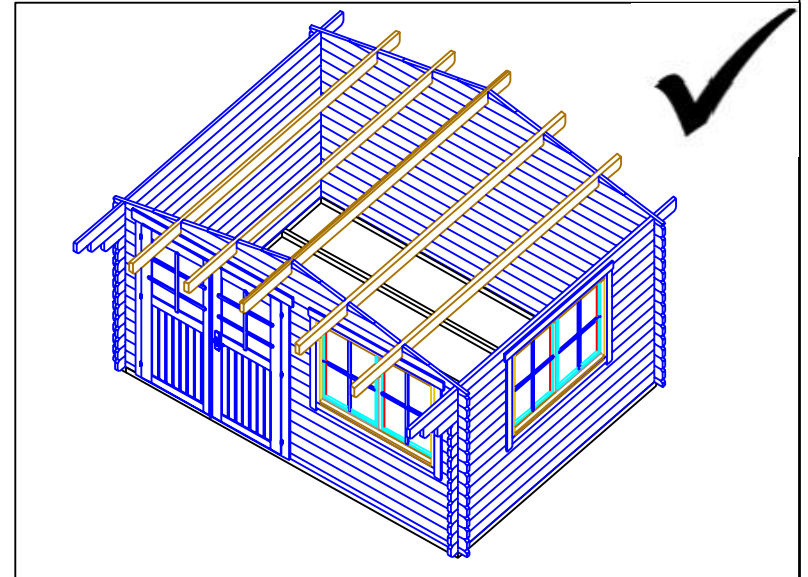
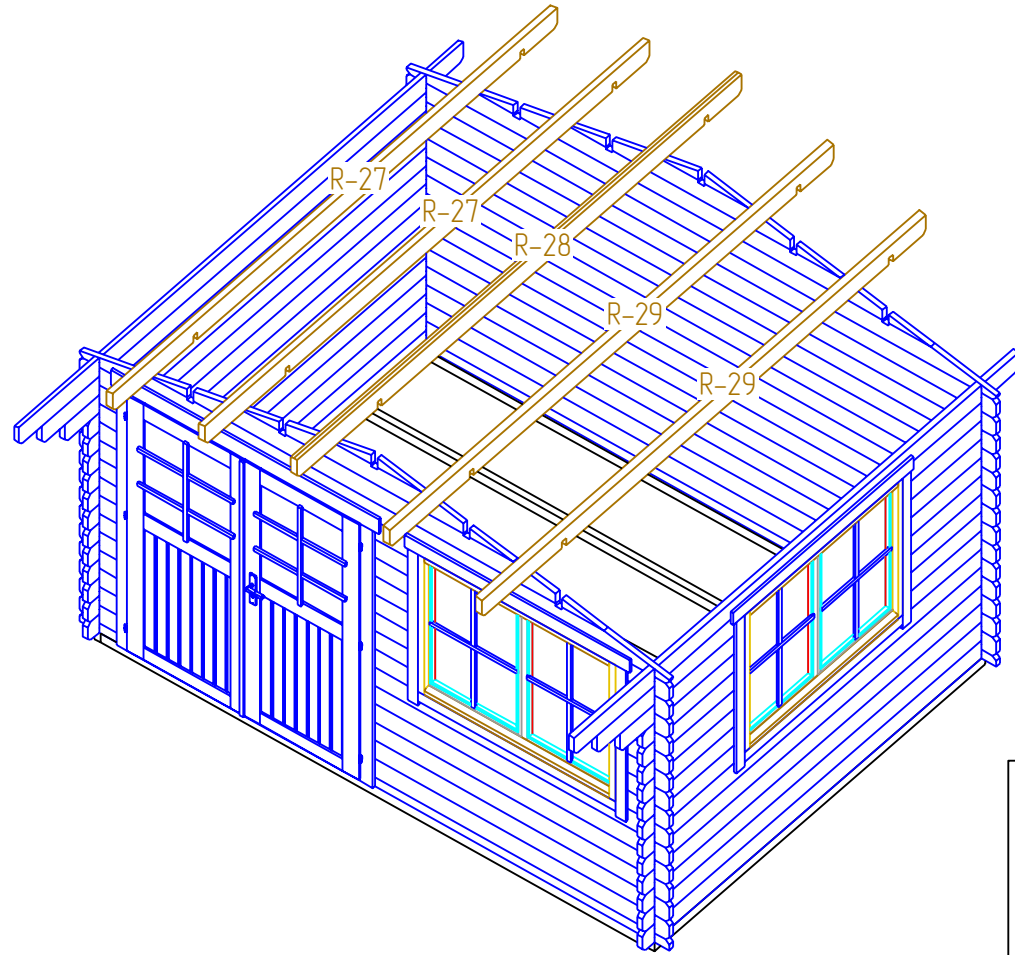



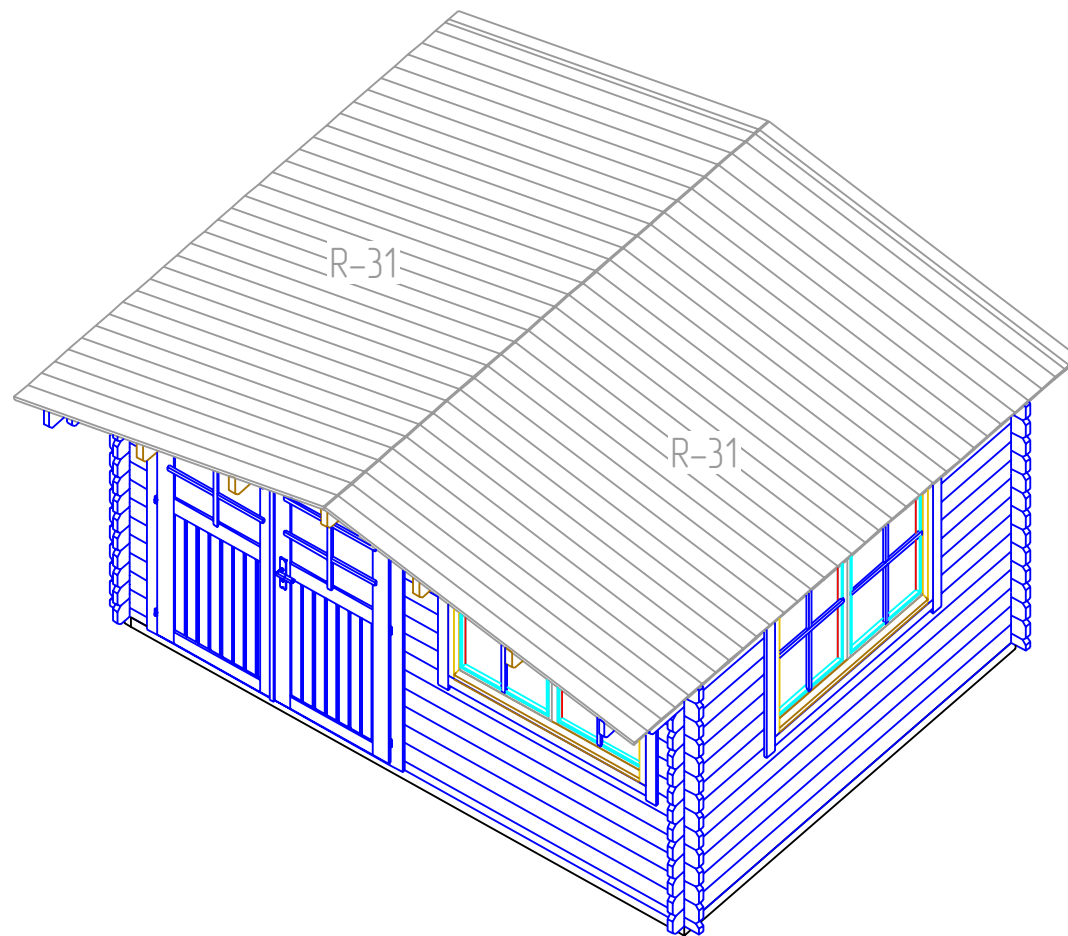

STAGE 6

Lillian 34 4X3

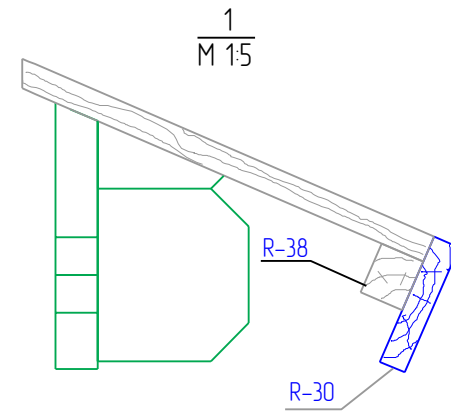
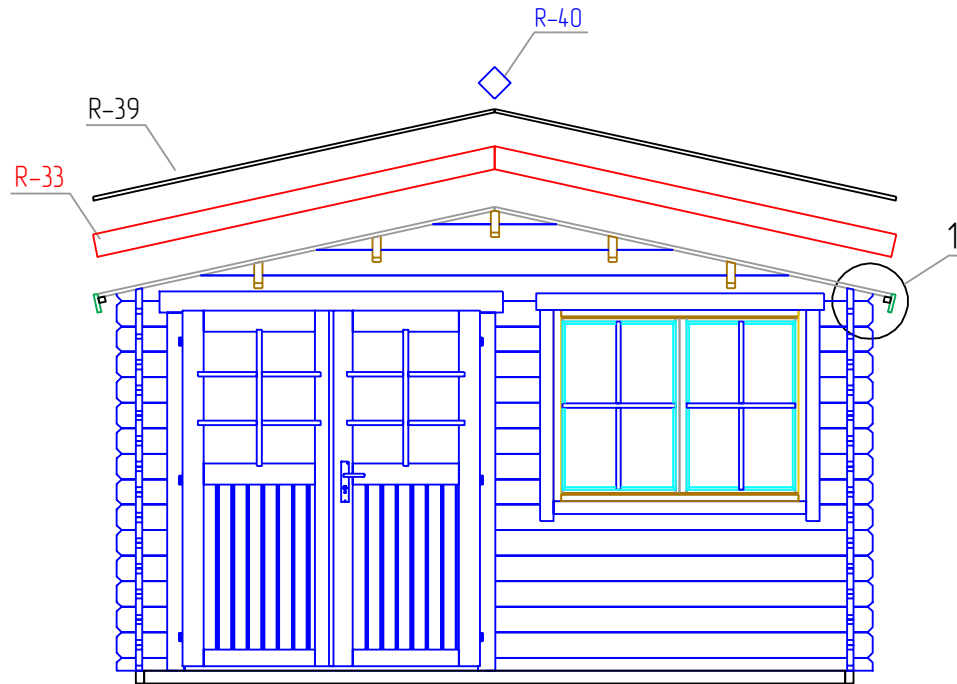

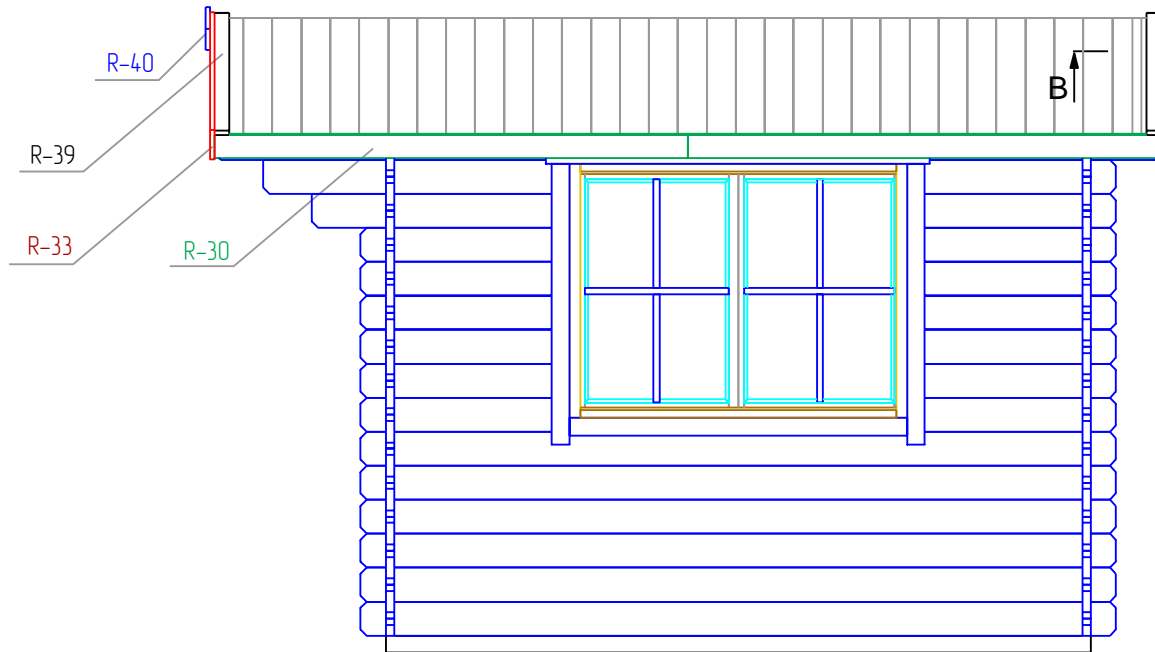

B

B-B  
M 15

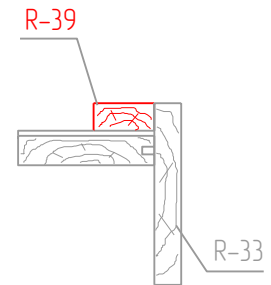

STAGE 7

Lillian 34 4X3

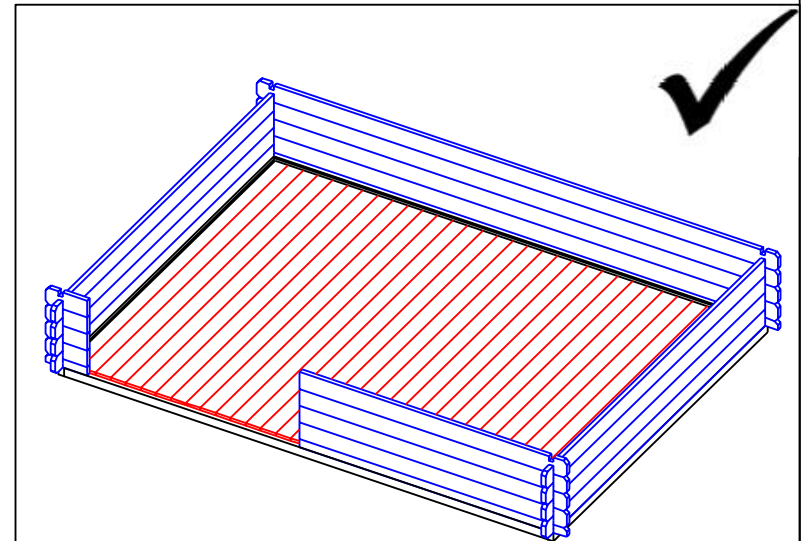
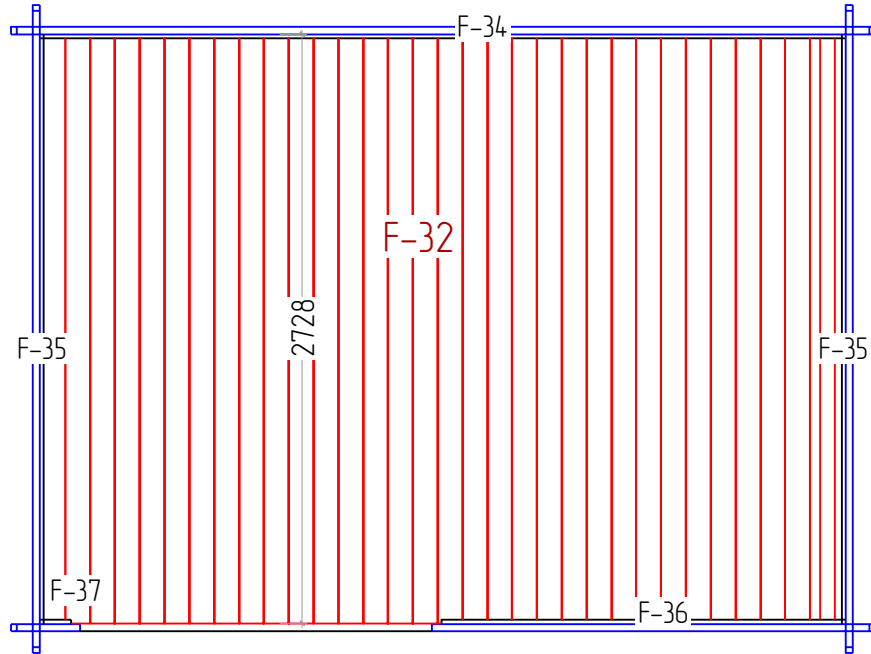

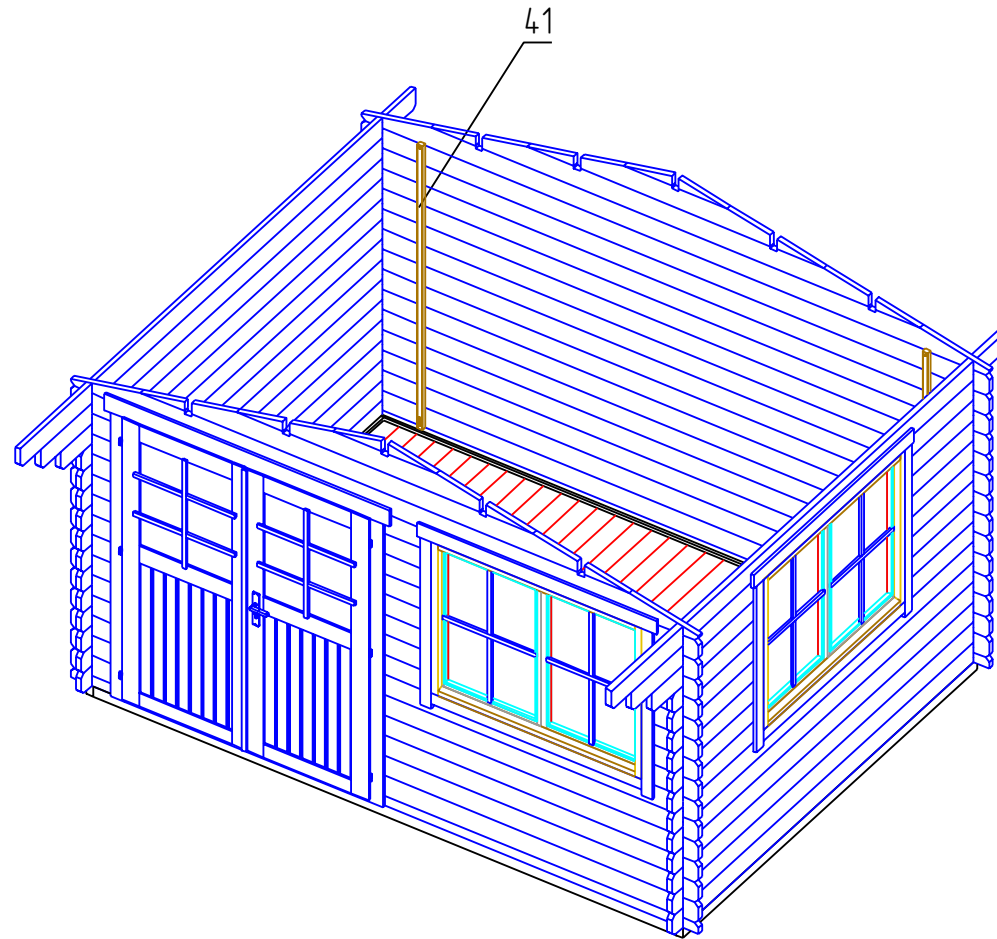

STAGE 1

F  
NR: 25  
PSC: 6  
B/H: 44mm/68mm  
L: 3712mm



F  
NR: 26  
PSC: 2  
B/H: 44mm/68mm  
L: 2800mm

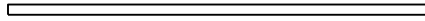

STAGE 2

W  
NR: A 1  
PSC: 1  
B/H: 34mm/68mm  
L: 2050mm

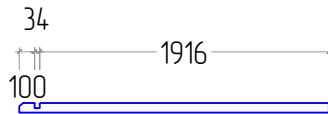

W  
NR: A 2  
PSC: 1  
B/H: 34mm/68mm  
L: 320mm

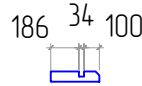

W  
NR: A 6  
PSC: 6  
B/H: 34mm/135mm  
L: 2050mm

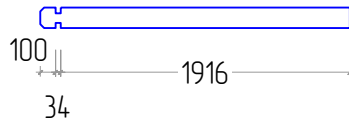

W  
NR: A 8  
PSC: 8  
B/H: 34mm/135mm  
L: 330mm



W  
NR: A 9  
PSC: 22  
B/H: 34mm/135mm  
L: 320mm

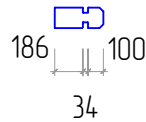

W  
NR: B 10  
PSC: 1  
B/H: 34mm/68mm  
L: 4000mm

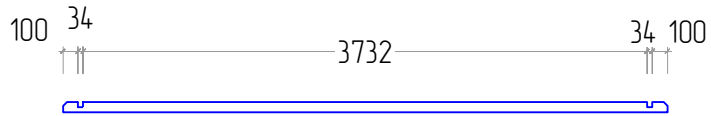

W  
NR: B 12  
PSC: 15  
B/H: 34mm/135mm  
L: 4000mm

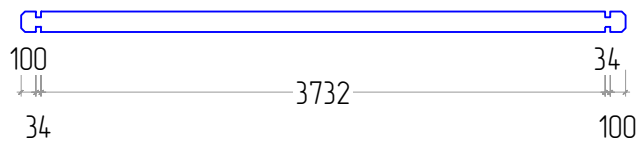

W  
NR: C 16  
PSC: 1  
B/H: 34mm/135mm  
L: 3760mm

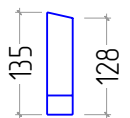
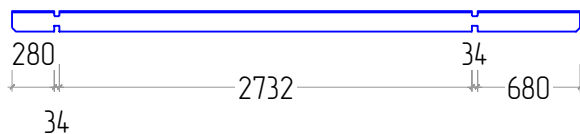

# Lillian 34 4X3

<p>W NR: C 17 PSC: 1 B/H: 34mm/135mm L: 3387mm</p>	
<p>W NR: C 18 PSC: 1 B/H: 34mm/135mm L: 3193mm</p>	
<p>W NR: C 19 PSC: 12 B/H: 34mm/135mm L: 3000mm</p>	
<p>W NR: D 20 PSC: 1 B/H: 34mm/135mm L: 3760mm</p>	
<p>W NR: D 21 PSC: 6 B/H: 34mm/135mm L: 3000mm</p>	
<p>W NR: D 22 PSC: 1 B/H: 34mm/135mm L: 1187mm</p>	
<p>W NR: D 23 PSC: 1 B/H: 34mm/135mm L: 993mm</p>	
<p>W NR: D 24 PSC: 14 B/H: 34mm/135mm L: 800mm</p>	
<p>W NR: A PSC: 1</p>	
<p>W NR: B PSC: 1</p>	

STAGE 3

Door

PSC: 1  
B/H: 1630mm/1958mm

Window

PSC: 2  
B/H: 1400mm/1080mm

STAGE 4

R

NR: 27  
PSC: 2  
B/H: 44mm/140mm  
L: 3760mm

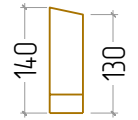

R

NR: 28  
PSC: 1  
B/H: 44mm/140mm  
L: 3760mm

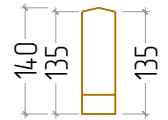

R

NR: 29  
PSC: 2  
B/H: 44mm/140mm  
L: 3760mm

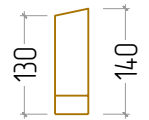

STAGE 5

R

NR: 31  
PSC: 67  
B/H: 20mm/115mm  
L: 2150mm



STAGE 6

R

NR: 30  
PSC: 4  
B/H: 18mm/95mm  
L: 1880mm



R

NR: 33  
PSC: 4  
B/H: 18mm/120mm  
L: 2178mm



R

NR: 38  
PSC: 4  
B/H: 28mm/34mm  
L: 1880mm



R

NR: 39  
PSC: 4  
B/H: 18mm/58mm  
L: 2173mm







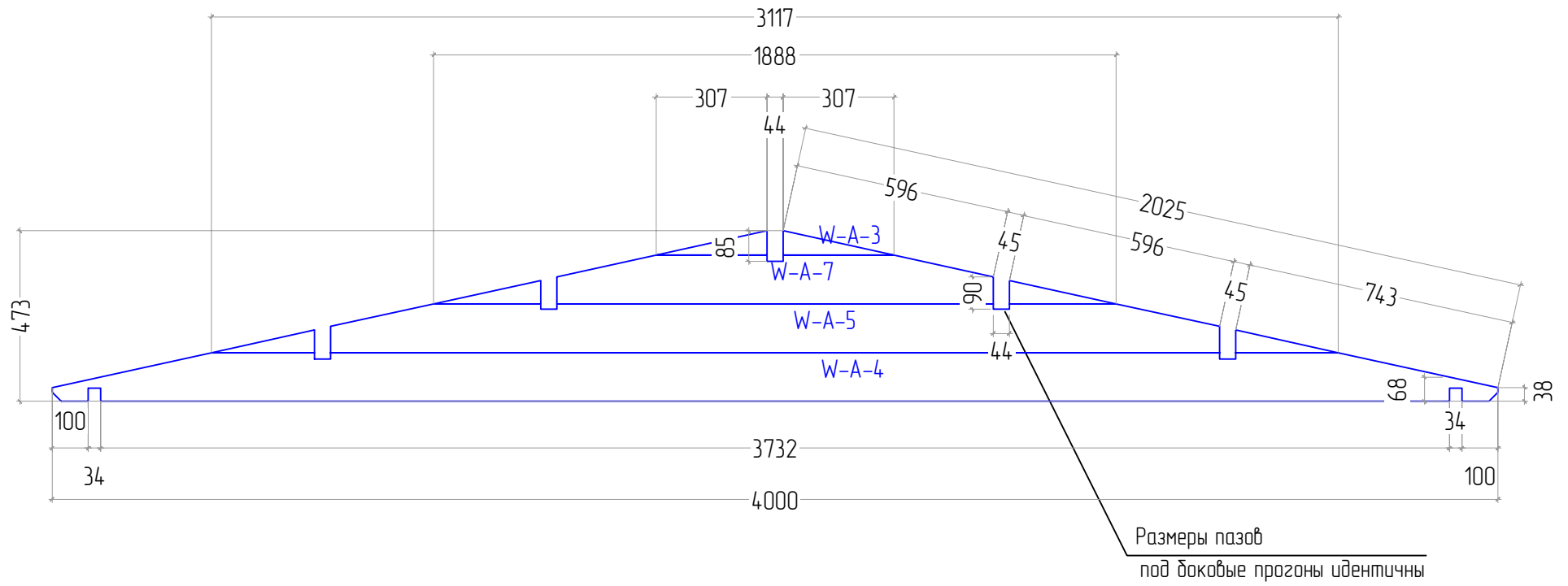

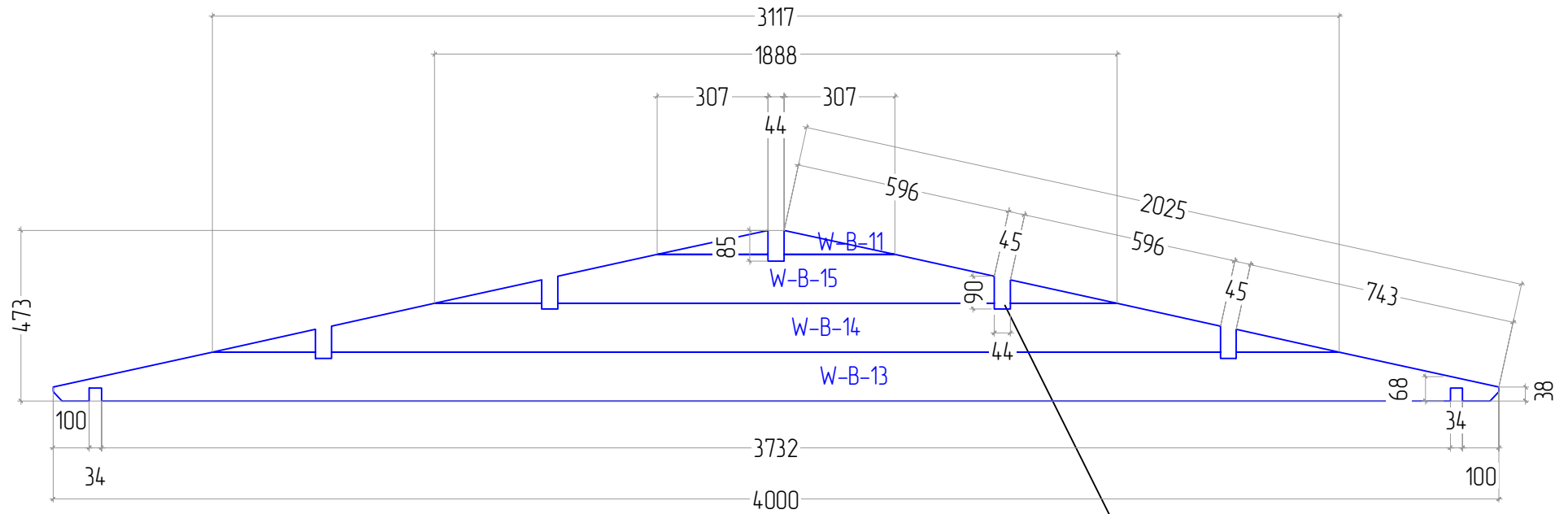

# W-A



# W-B

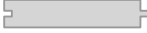

Размеры пазов  
под дощевые прогоны идентичны

<p>R NR: 40 PSC: 2 B/H: 18mm/120mm L: 120mm</p>	
<p>STAGE 7</p>	
<p>F NR: 32 PSC: 34 B/H: 20mm/115mm L: 2728mm</p>	
<p>F NR: 34 PSC: 1 B/H: 18mm/20mm L: 3732mm</p>	
<p>F NR: 35 PSC: 2 B/H: 18mm/20mm L: 2732mm</p>	
<p>F NR: 36 PSC: 1 B/H: 18mm/20mm L: 1873mm</p>	
<p>F NR: 37 PSC: 1 B/H: 18mm/20mm L: 143mm</p>	
<p>STAGE 8</p>	
<p>NR: 41 PSC: 4 B/H: 28mm/34mm L: 1900mm</p>	