

6x6
Plan

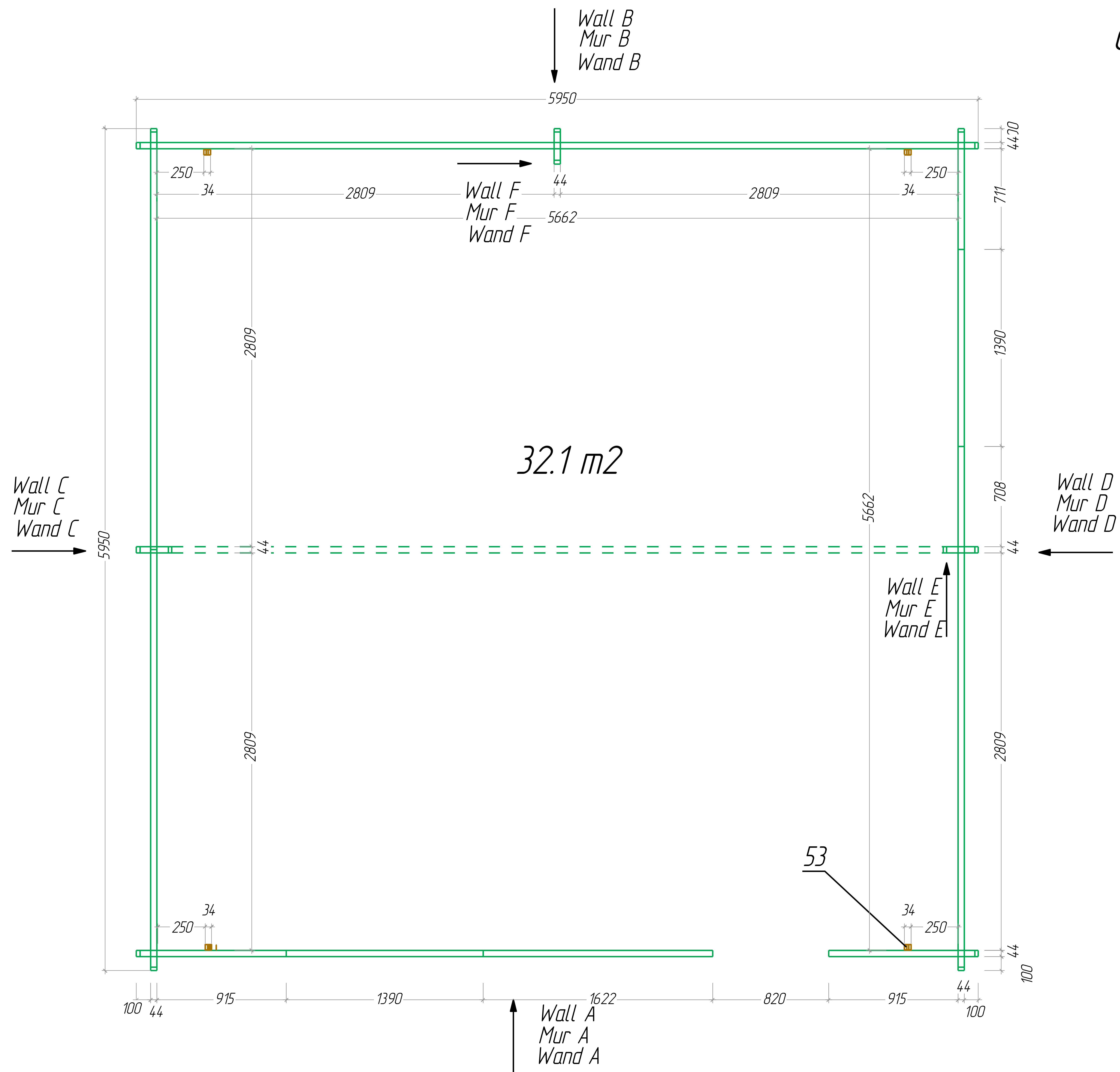

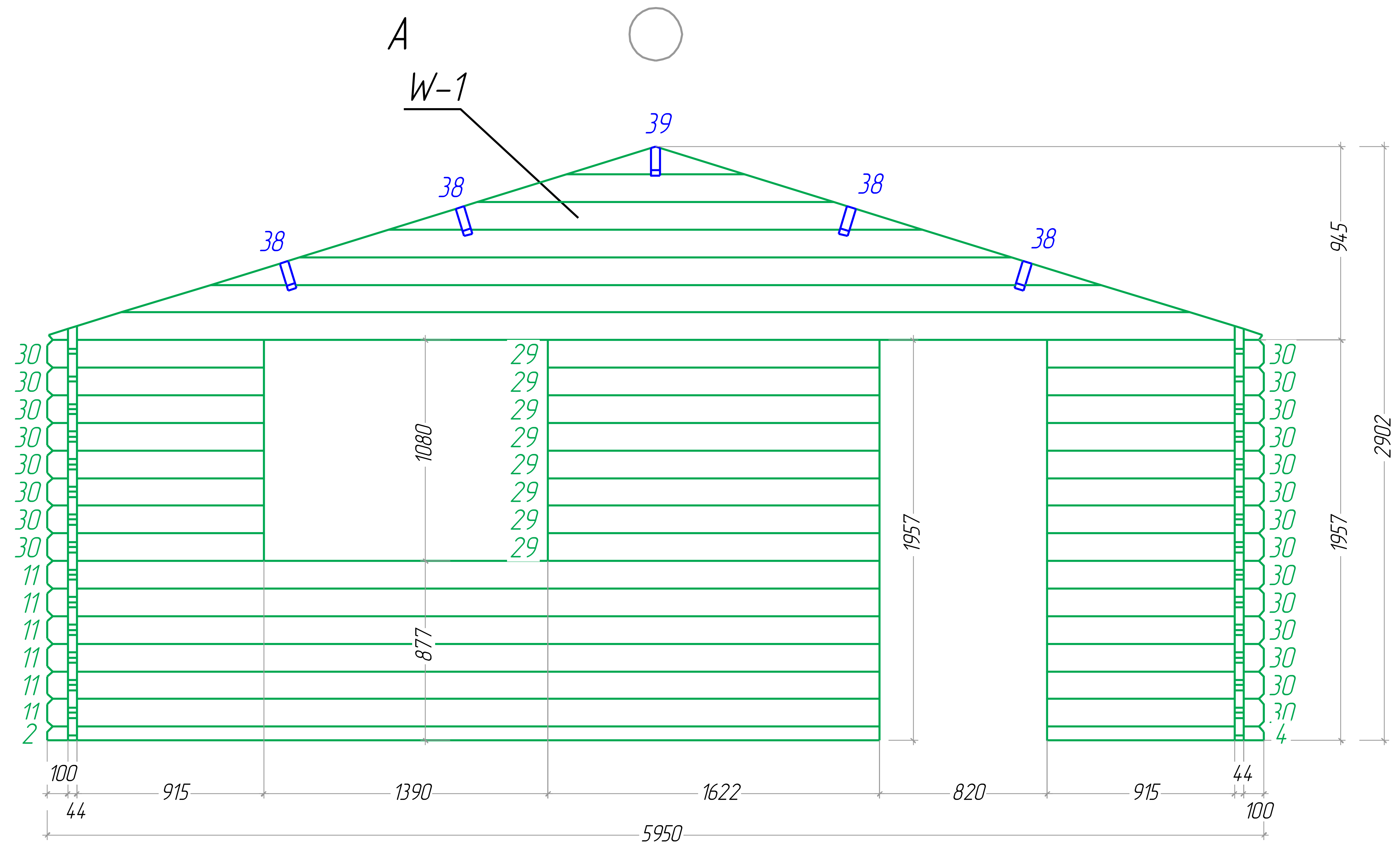

D

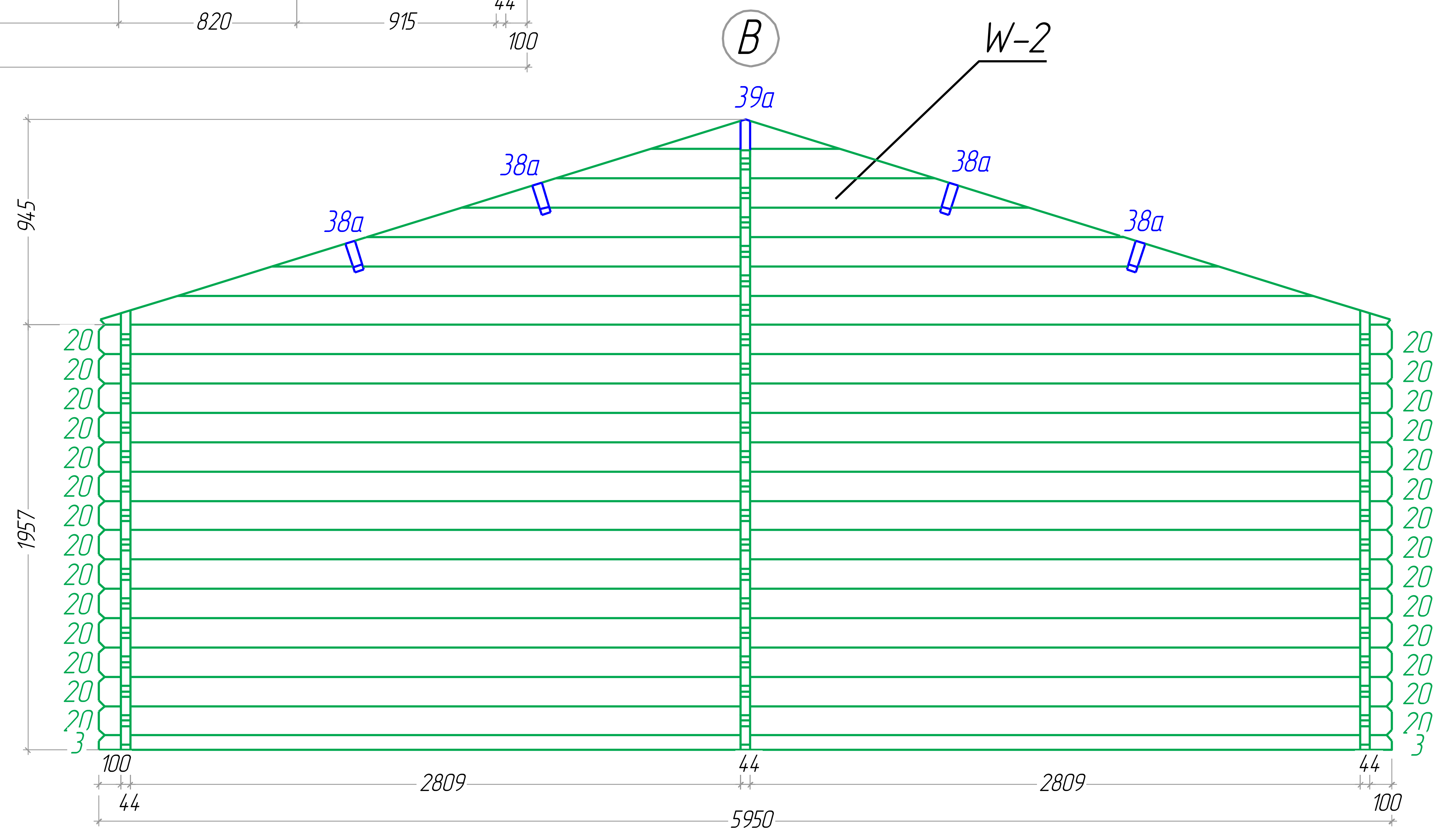

6x6

C

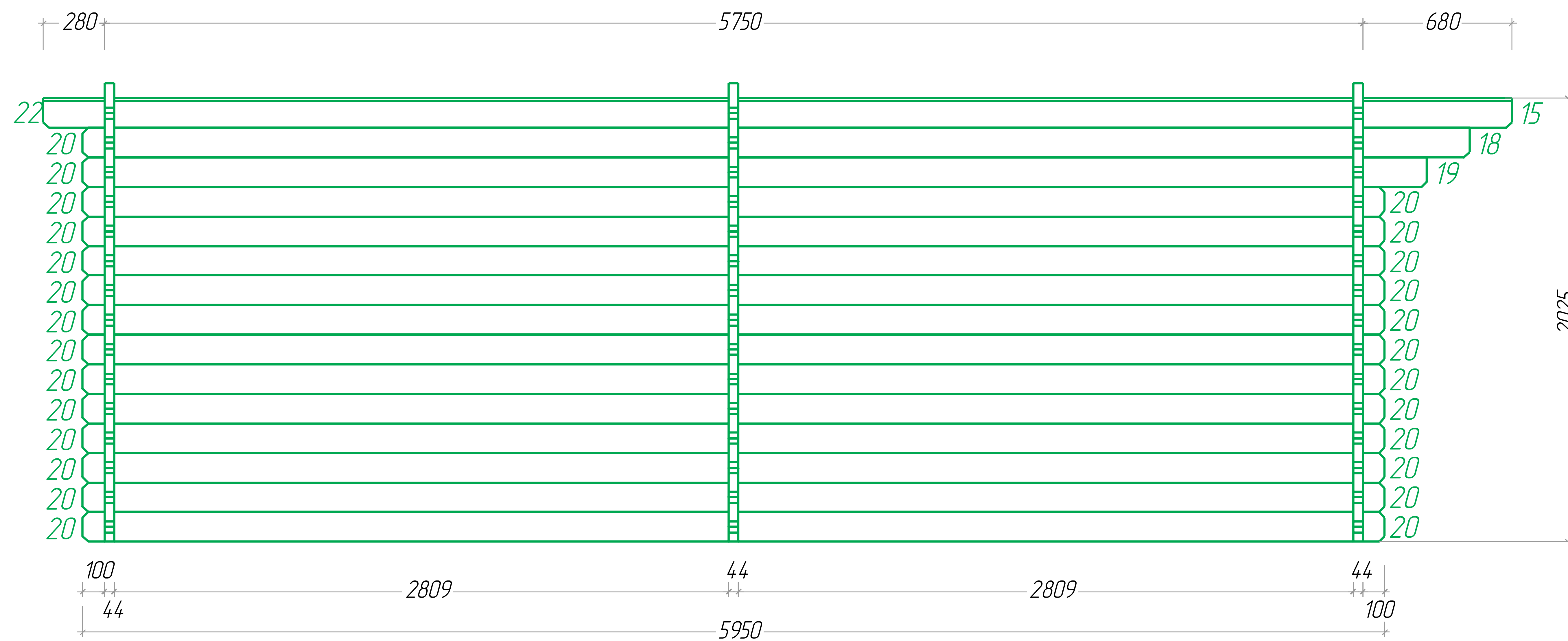

D

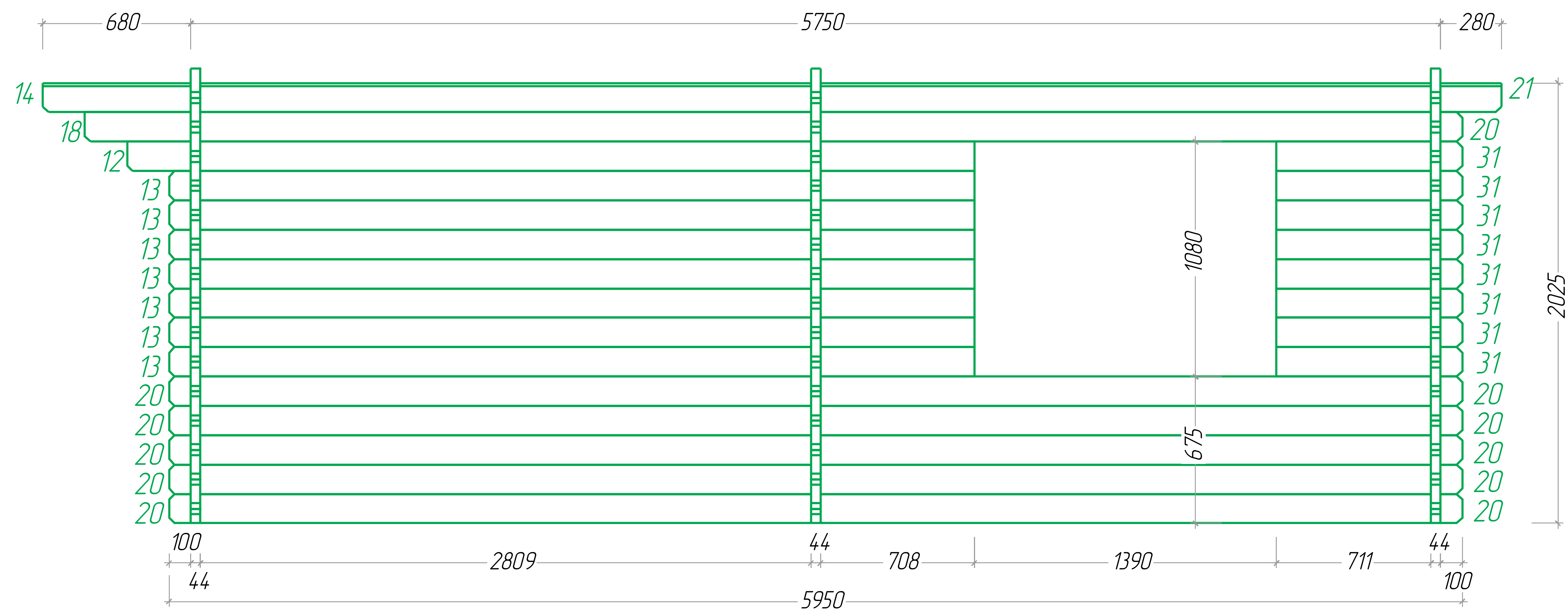

6x6

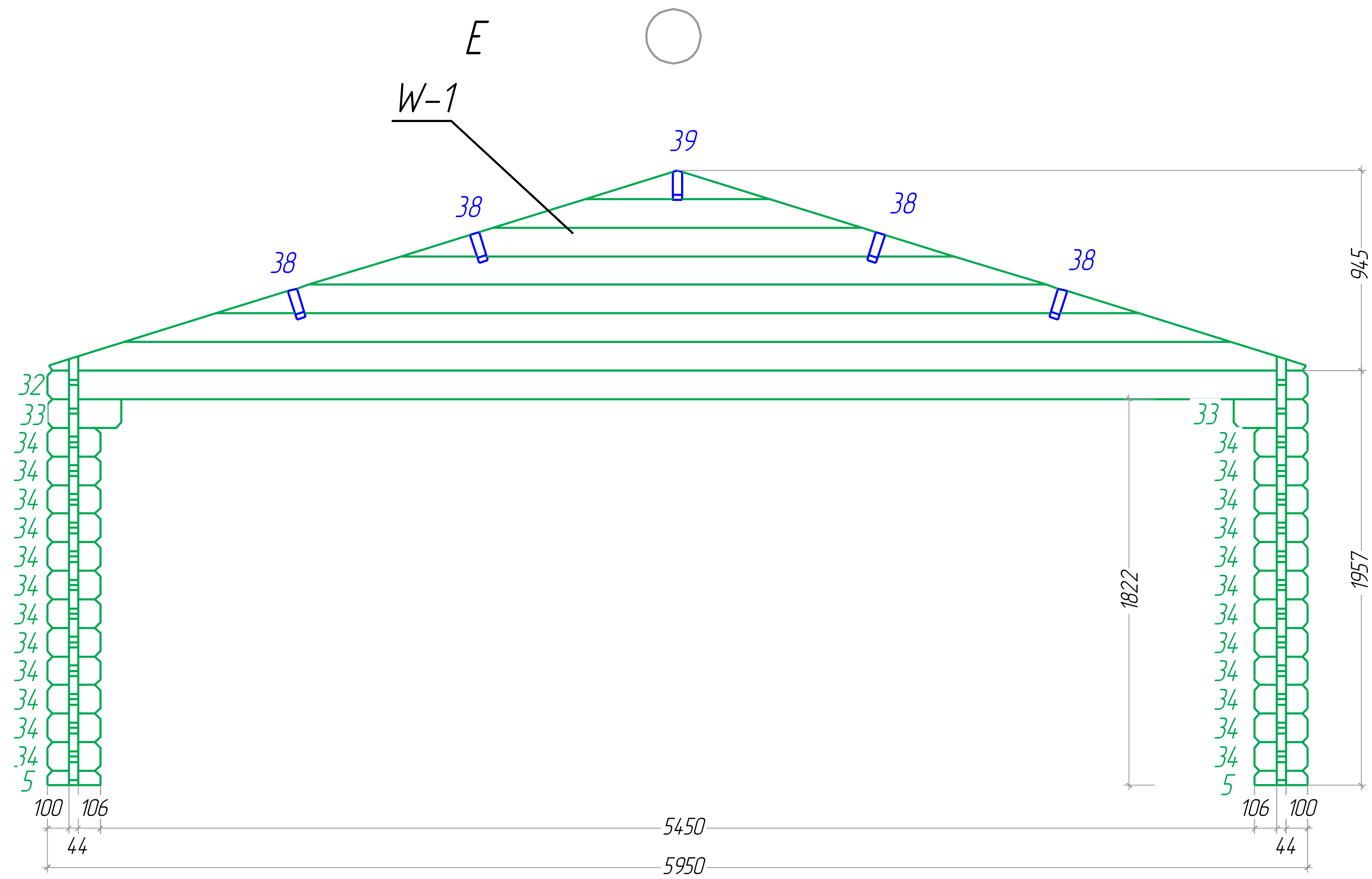

F

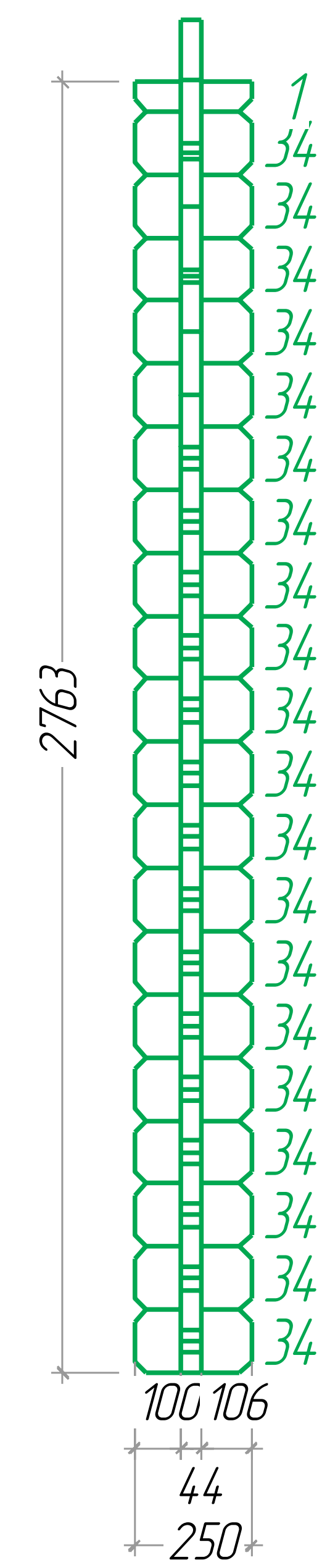

6x6

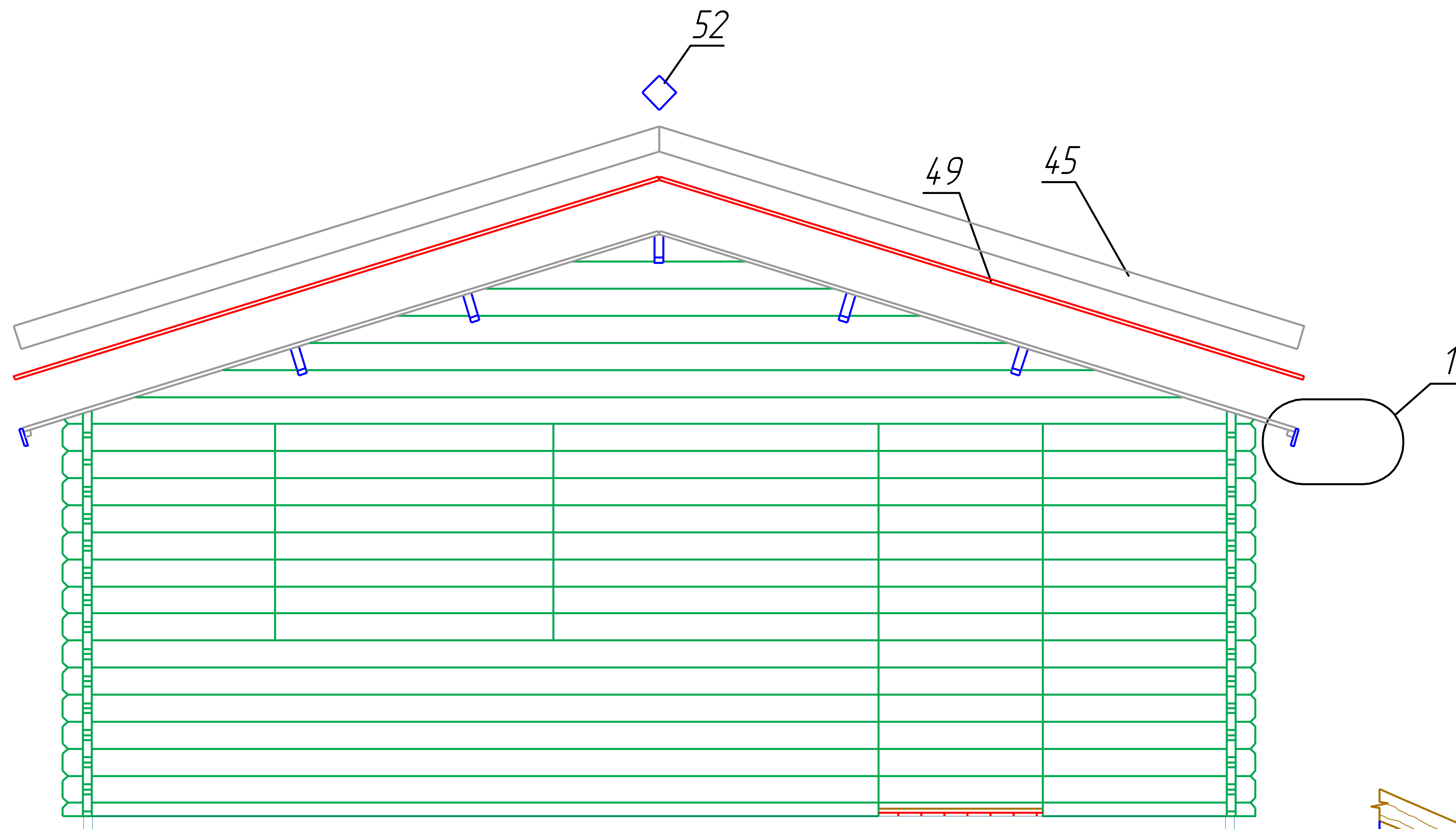

$\frac{1}{M 1:5}$

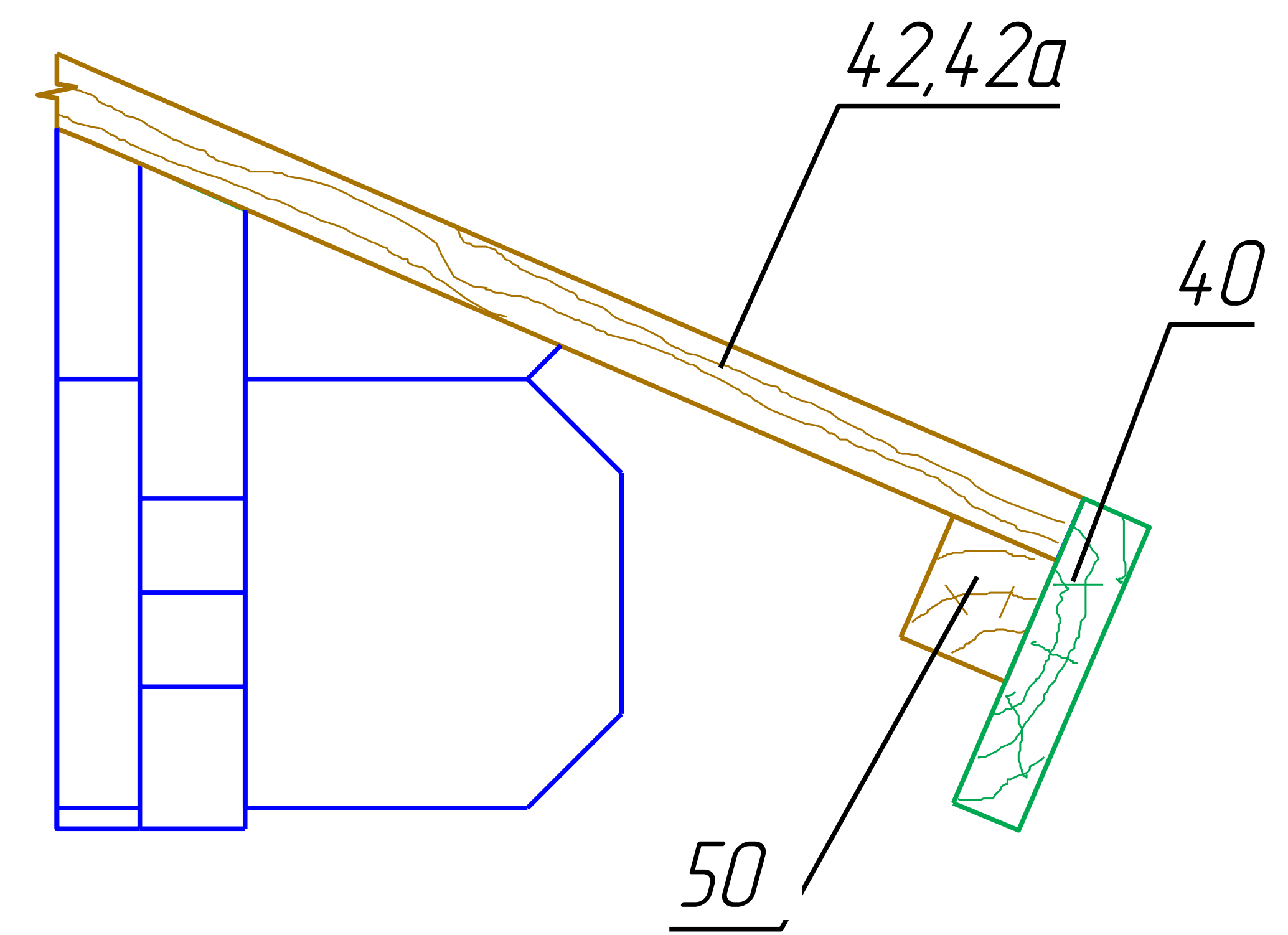

6x6

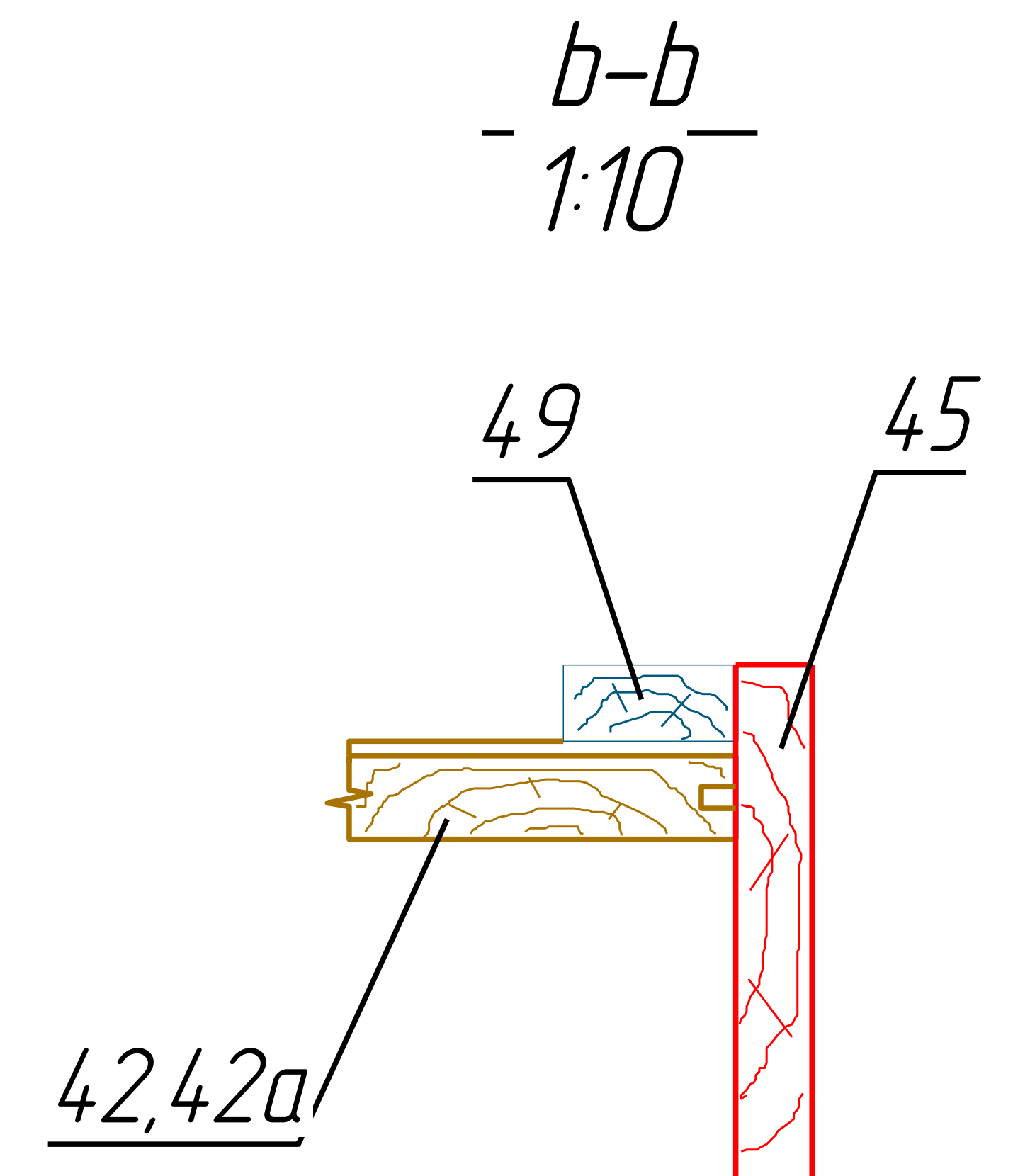
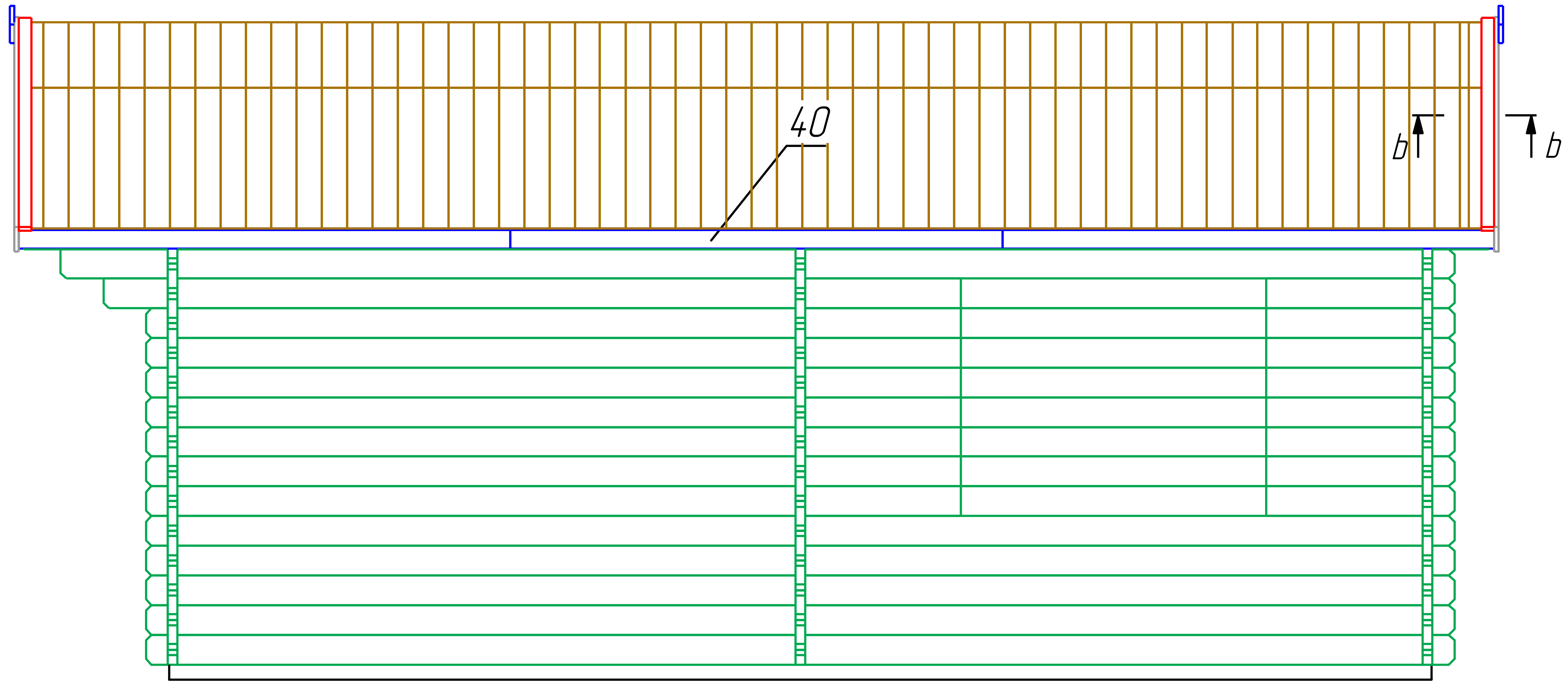

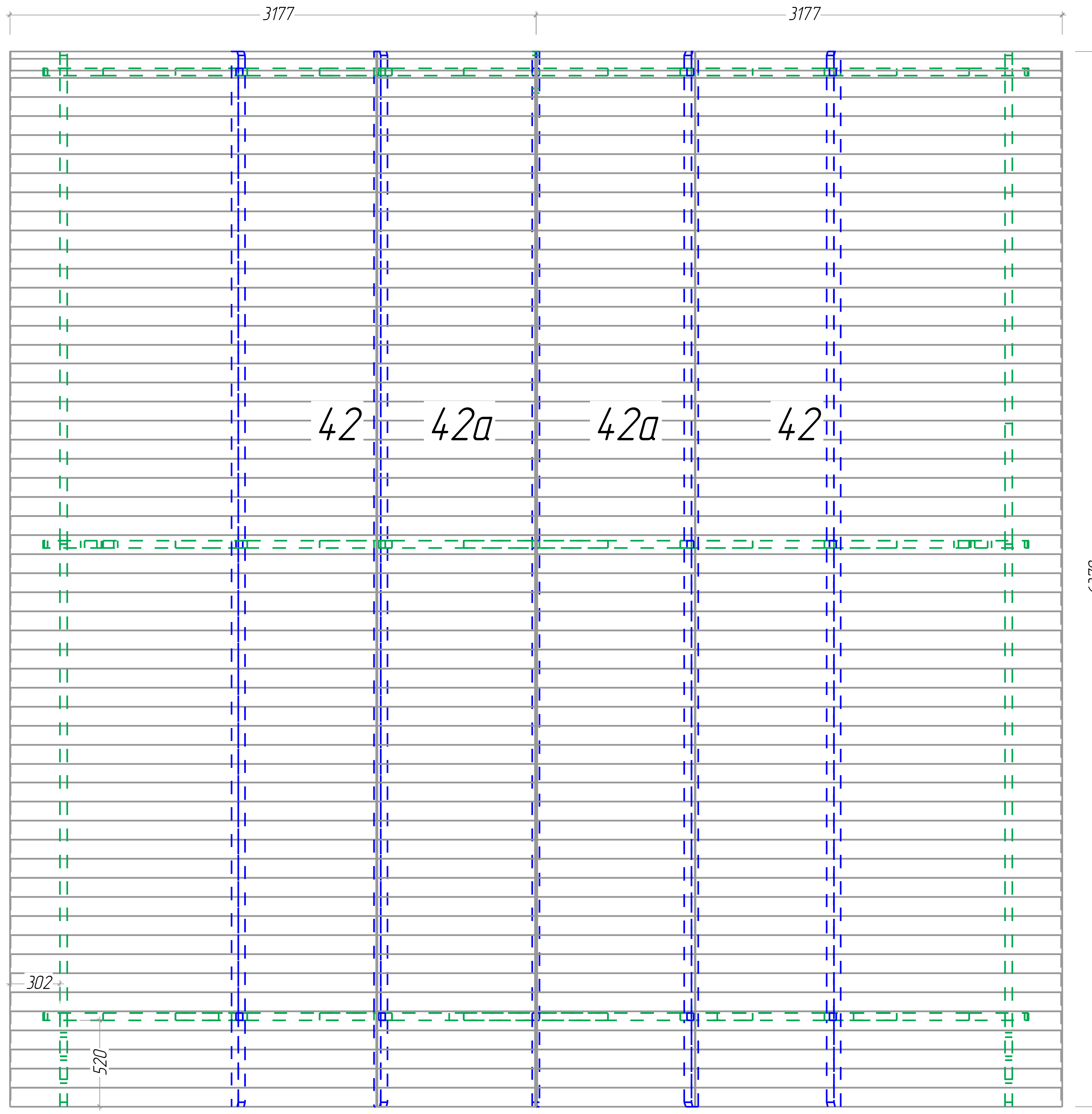

6x6

Plan of the roof board
Plan der Dachbretter
Le plan des planches du toit

6x6

Boarding joist plan
Trummplan
Lambourde plan

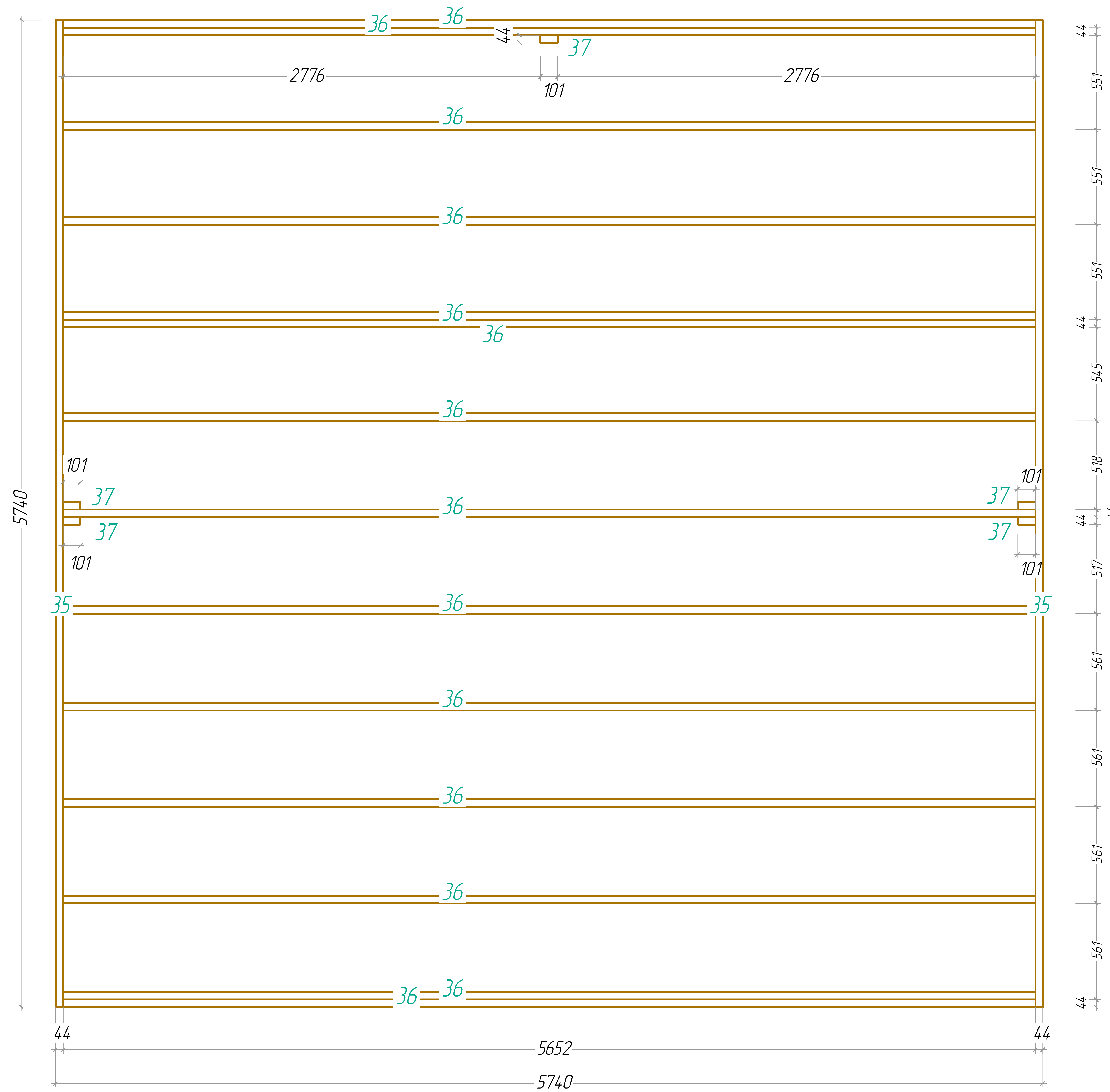





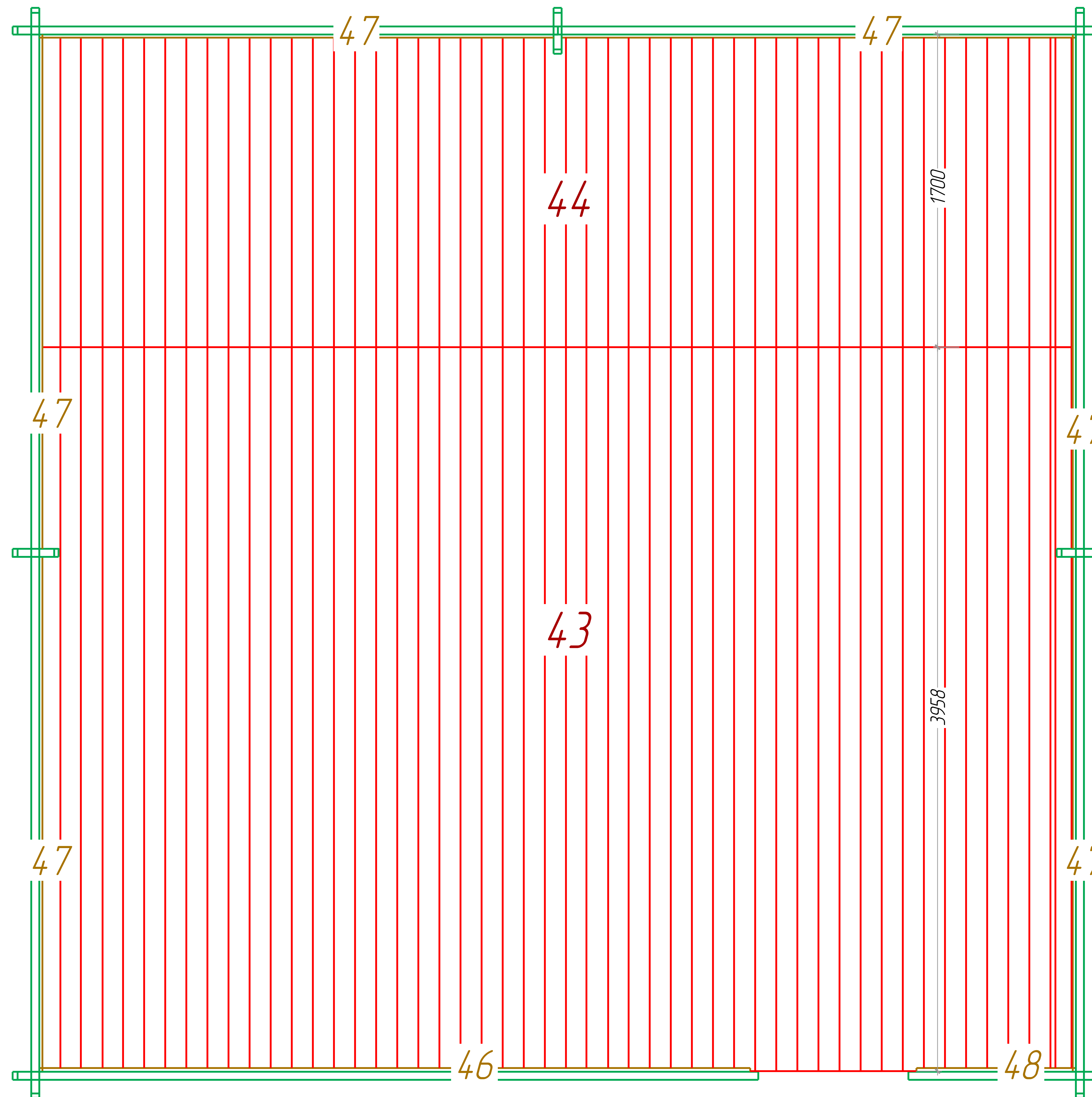

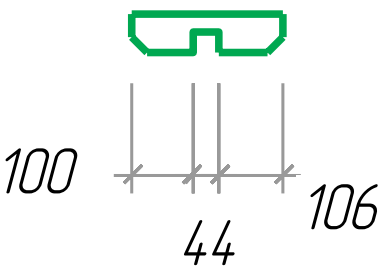
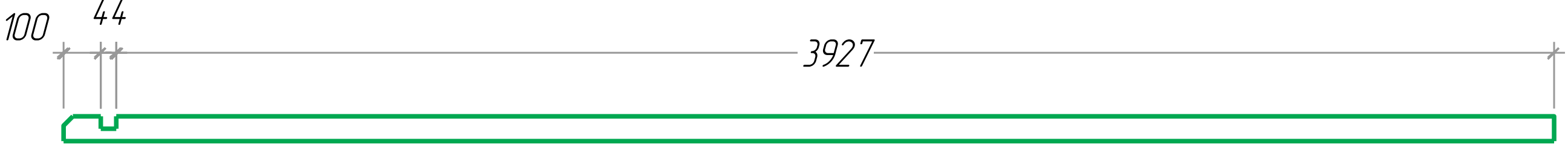
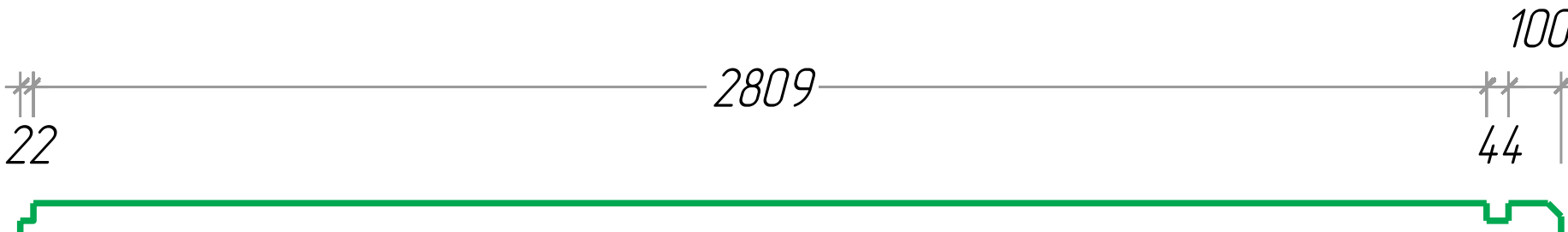
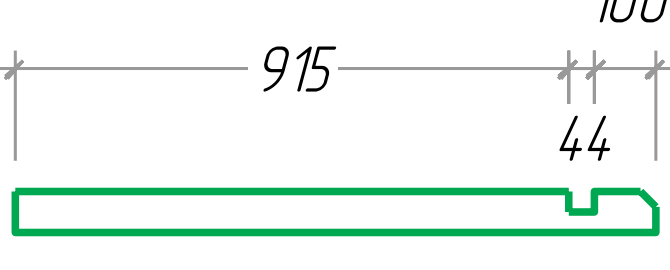
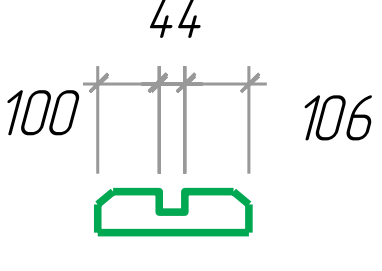
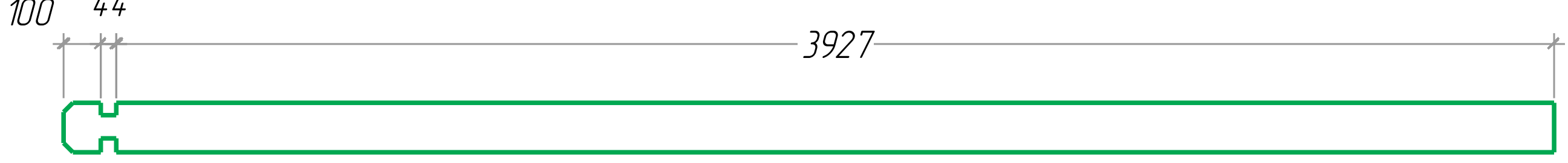
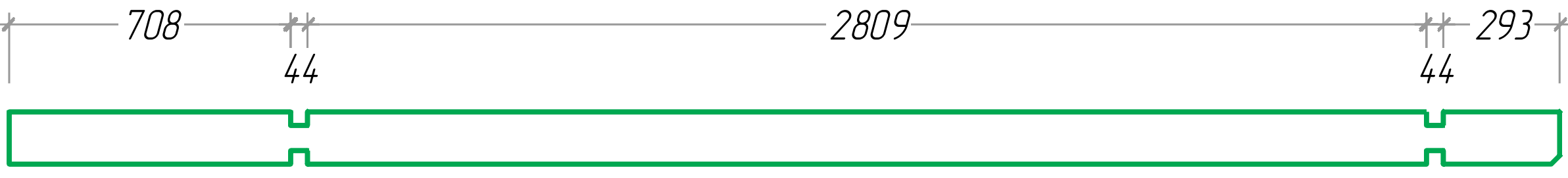
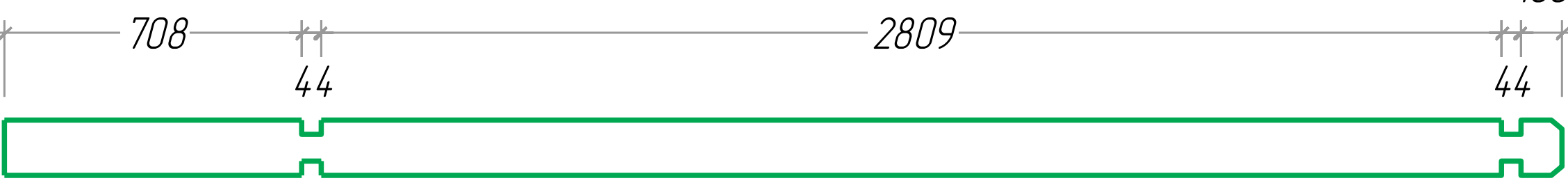
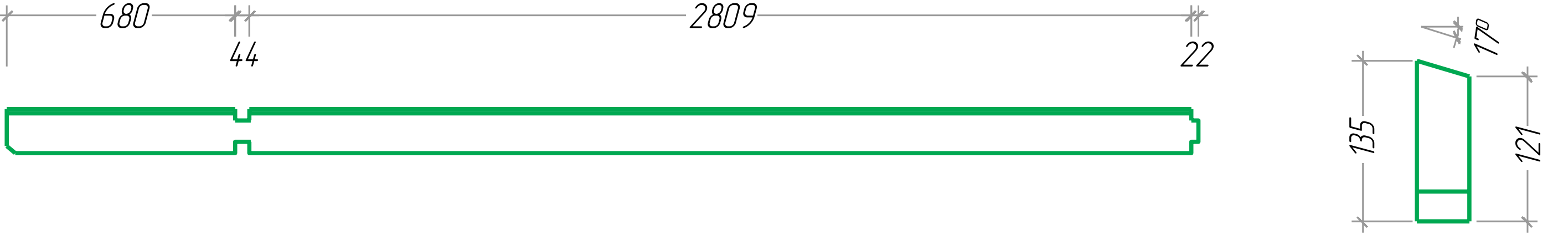
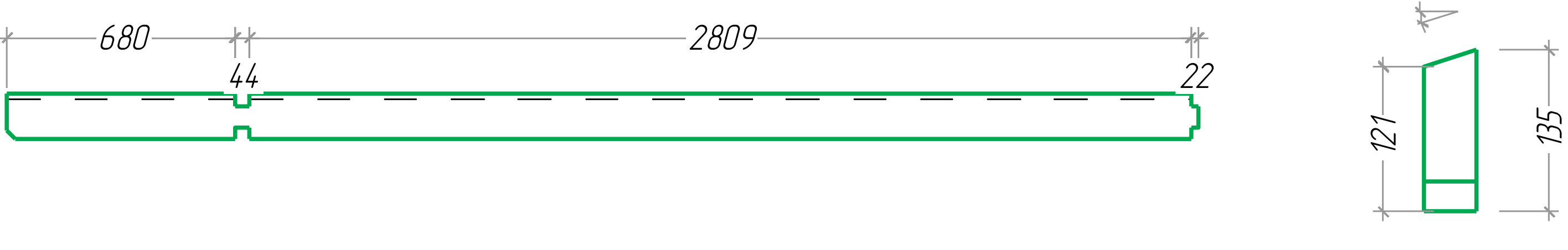
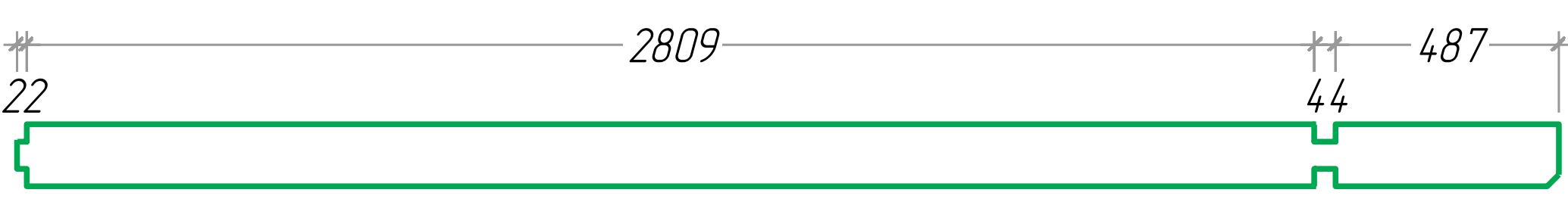
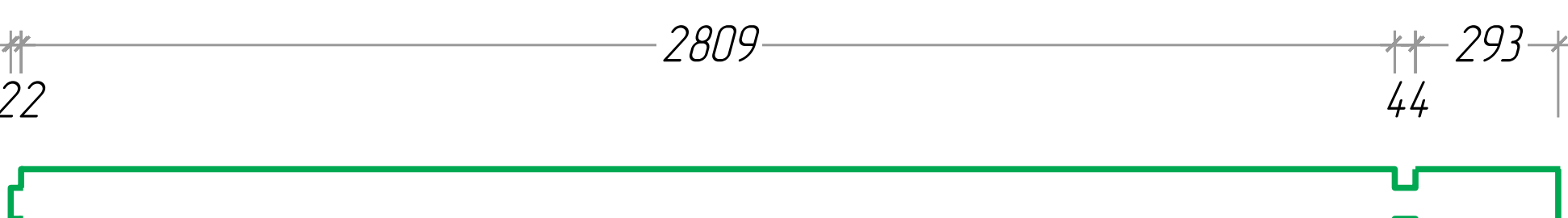
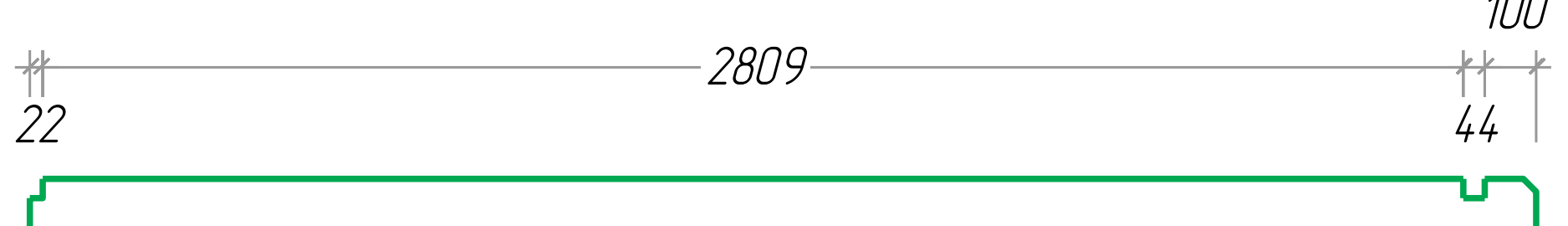

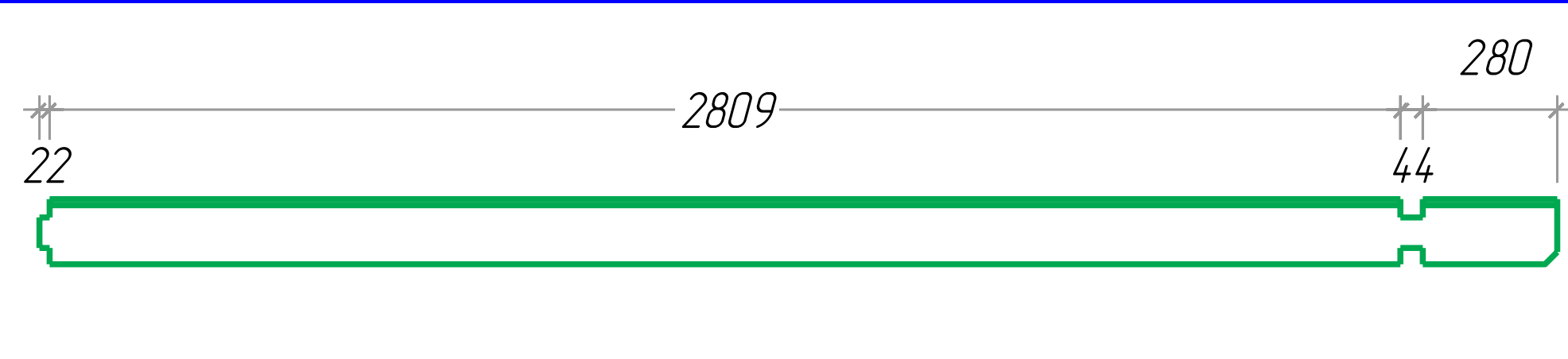
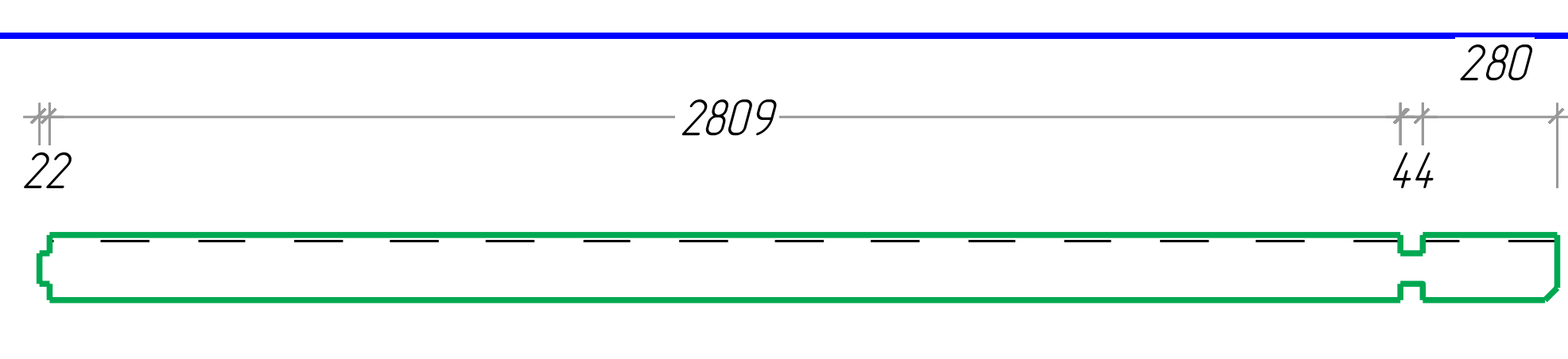
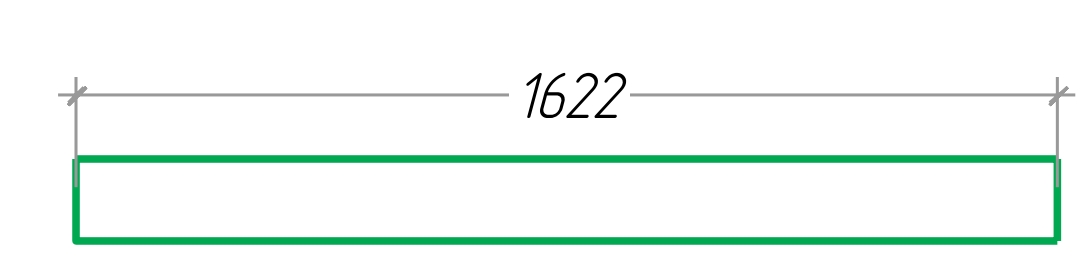
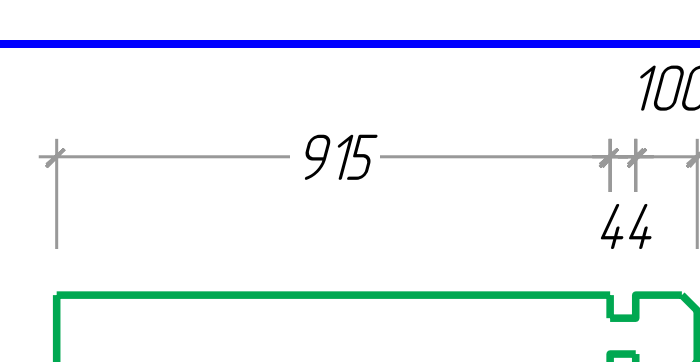
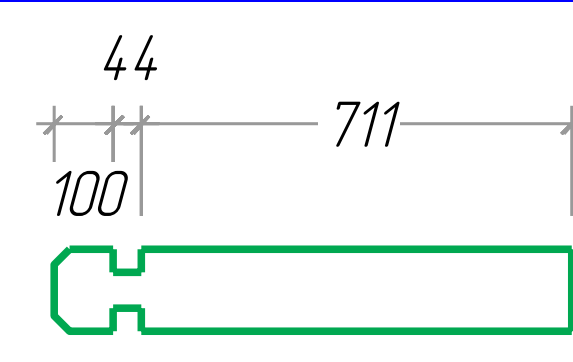
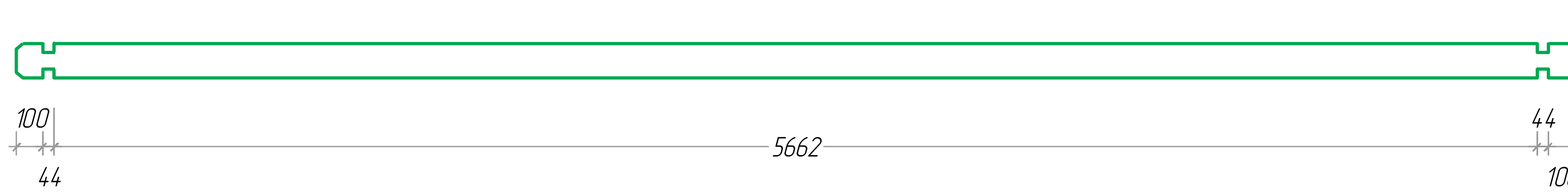
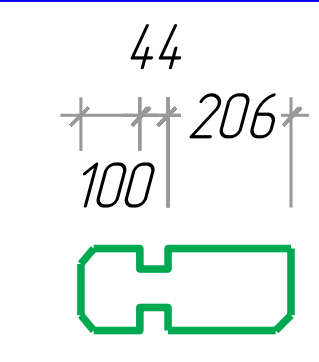
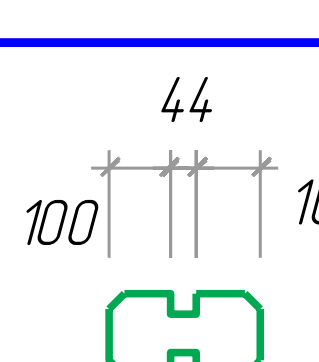



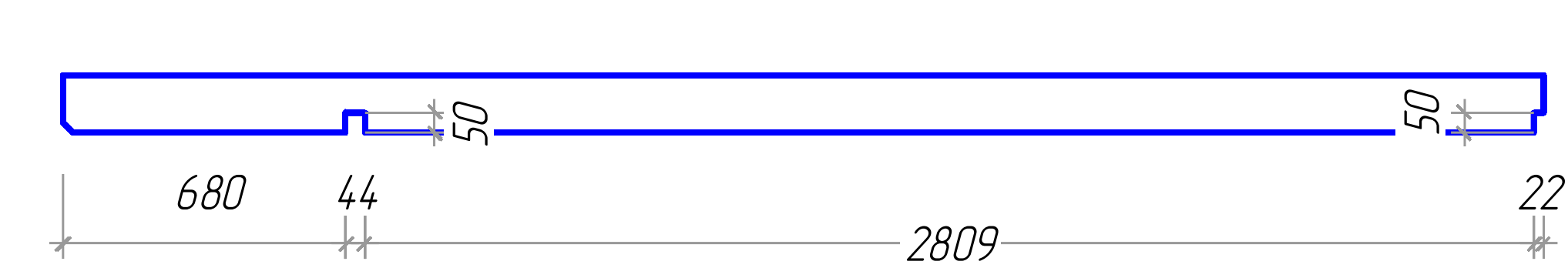
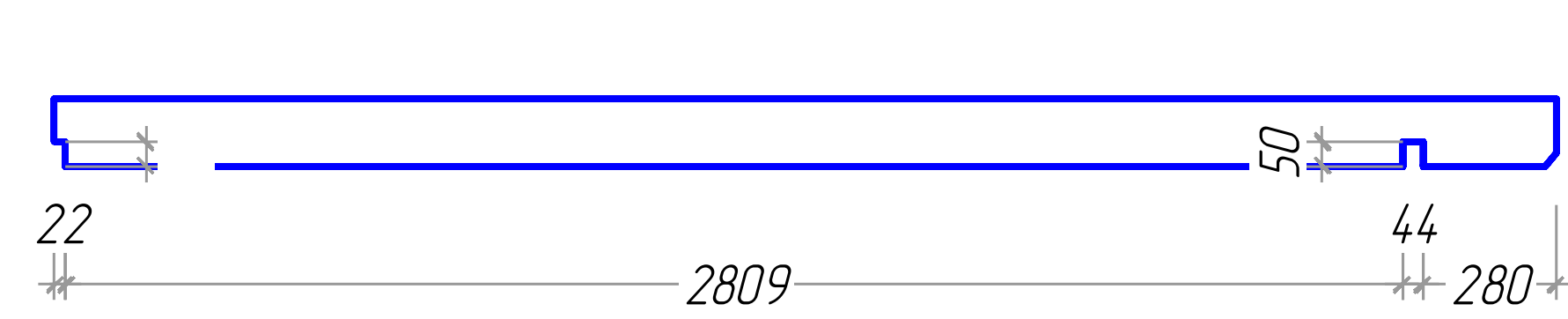

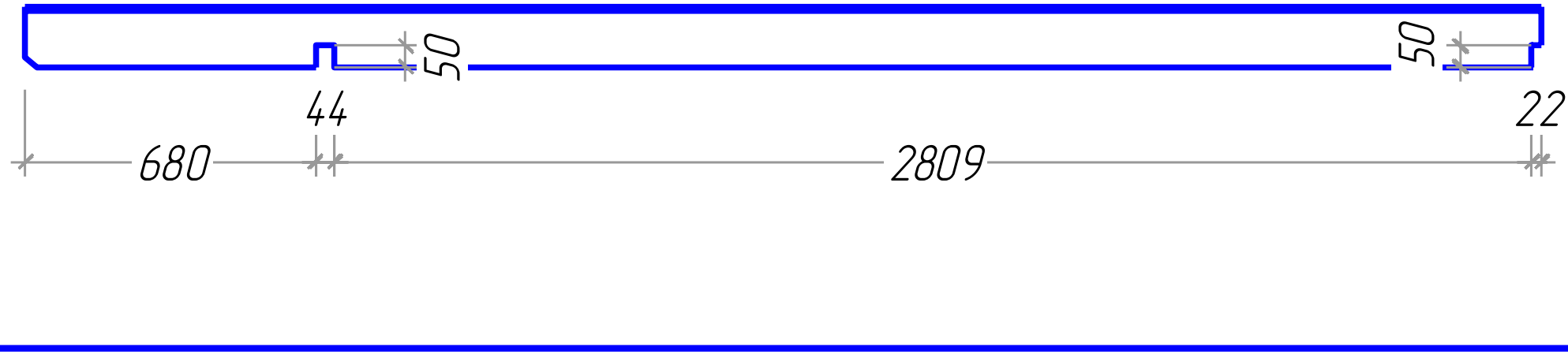
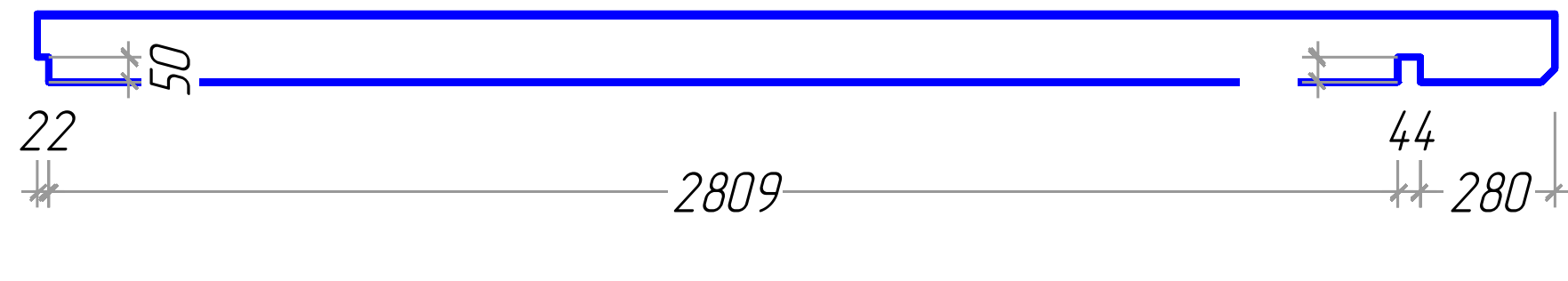
6x6

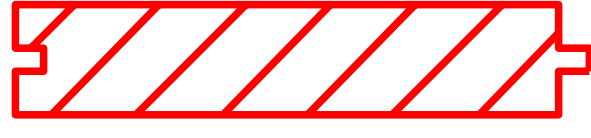
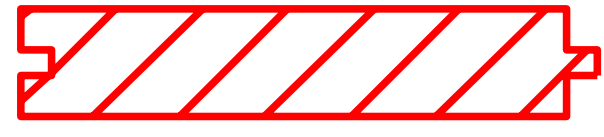
Plan of the floor board
Plan der Furbodenbretter
Le plan des plaches du plancher

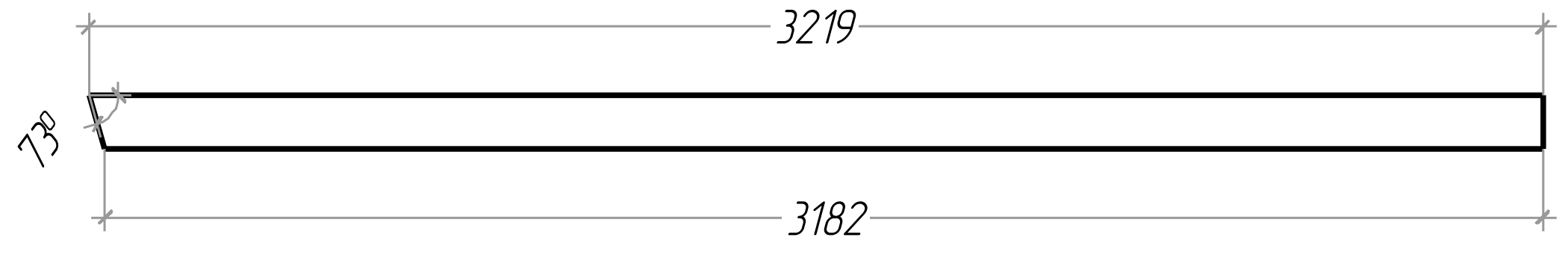

№	M150	Nr.	Profile (mm)	Lenght (mm)
1		1	44x62,5	250mm
2		1	44x67,5	4071mm
3		2	44x67,5	2975mm
4		1	44x67,5	1059mm
5		2	44x67,5	250mm
11		6	44x135	4071mm
12		1	44x135	3898mm
13		7	44x135	3705mm
14		1	44x135	3555mm
15		1	44x135	3555mm
18		2	44x135	3362mm
19		1	44x135	3168mm
20		65+2	44x135	2975mm

Nº	M150	Nr.	Profile (mm)	Length (mm)
21		1	44x135	3155mm
22		1	44x135	3155mm
29		8	44x135	1622mm
30		22	44x135	1059mm
31		8	44x135	855mm
32		1	44x135	5950mm
33		2	44x135	350mm
34		44	44x135	250mm
35		2	44x68	5740mm
36		14	44x68	5652mm
37		5	44x68	101mm
38		4	44x140	3555mm
38a		4	44x140	3155mm

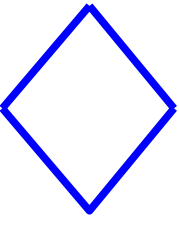
N ^o	M150	Nr.	Profile (mm)	Lenght (mm)
39		1	44x140	3555mm
39a		1	44x140	3155mm
40		6	18x90	2236mm
42 / 42a		118+1 / 118+1	20x115	2166mm / 1003mm
43		50+1	20x115	3958mm
44		50+1	20x115	1700mm
45		4	20x120	3219mm
46		1	18x20	3884mm
47		6	18x20	2809mm
48		1	18x20	872mm
49		4	20x58	3212mm
50		6	28x34	2236mm
52		2	20x120	120mm

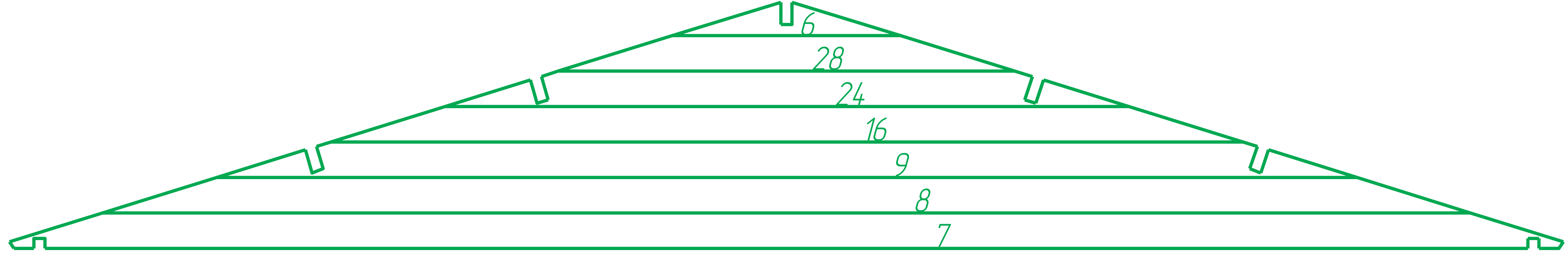
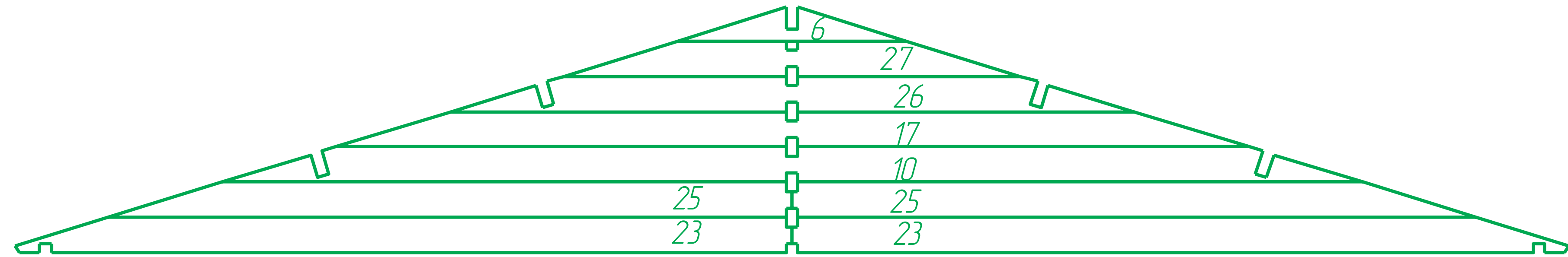
N ^o	M150	Nr.	Profile (mm)	Lenght (mm)
				
W-1		2		
W-2		1		
	<p>Door Tur La porte</p> <p>1928x810 mm</p>	1		
	<p>Window Fenetre Fenster</p>	2		

W-1

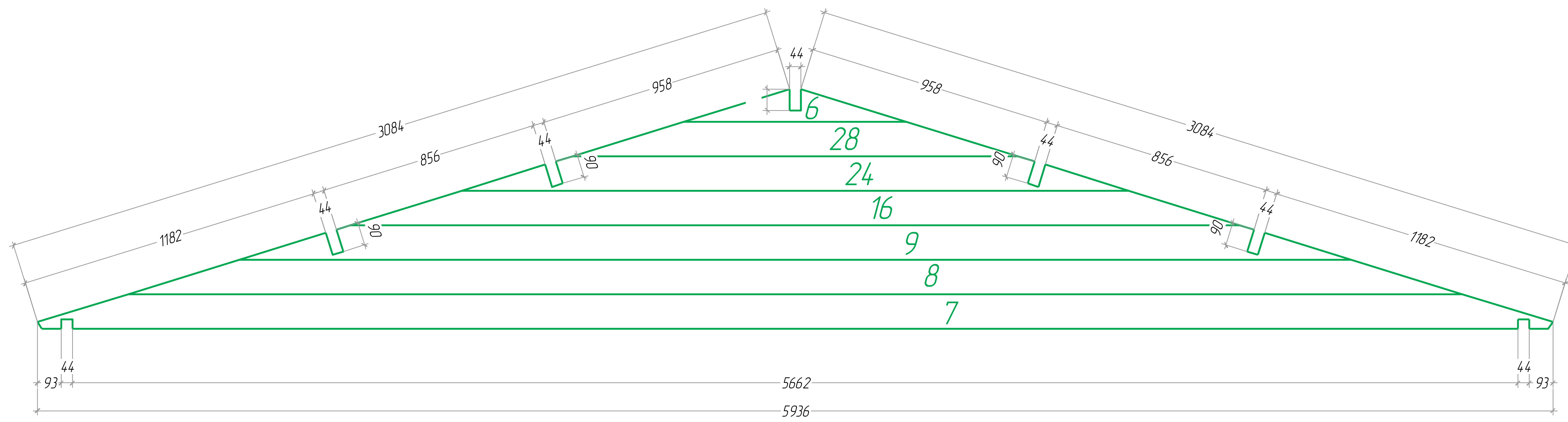

W-2

