

4x4

Plan

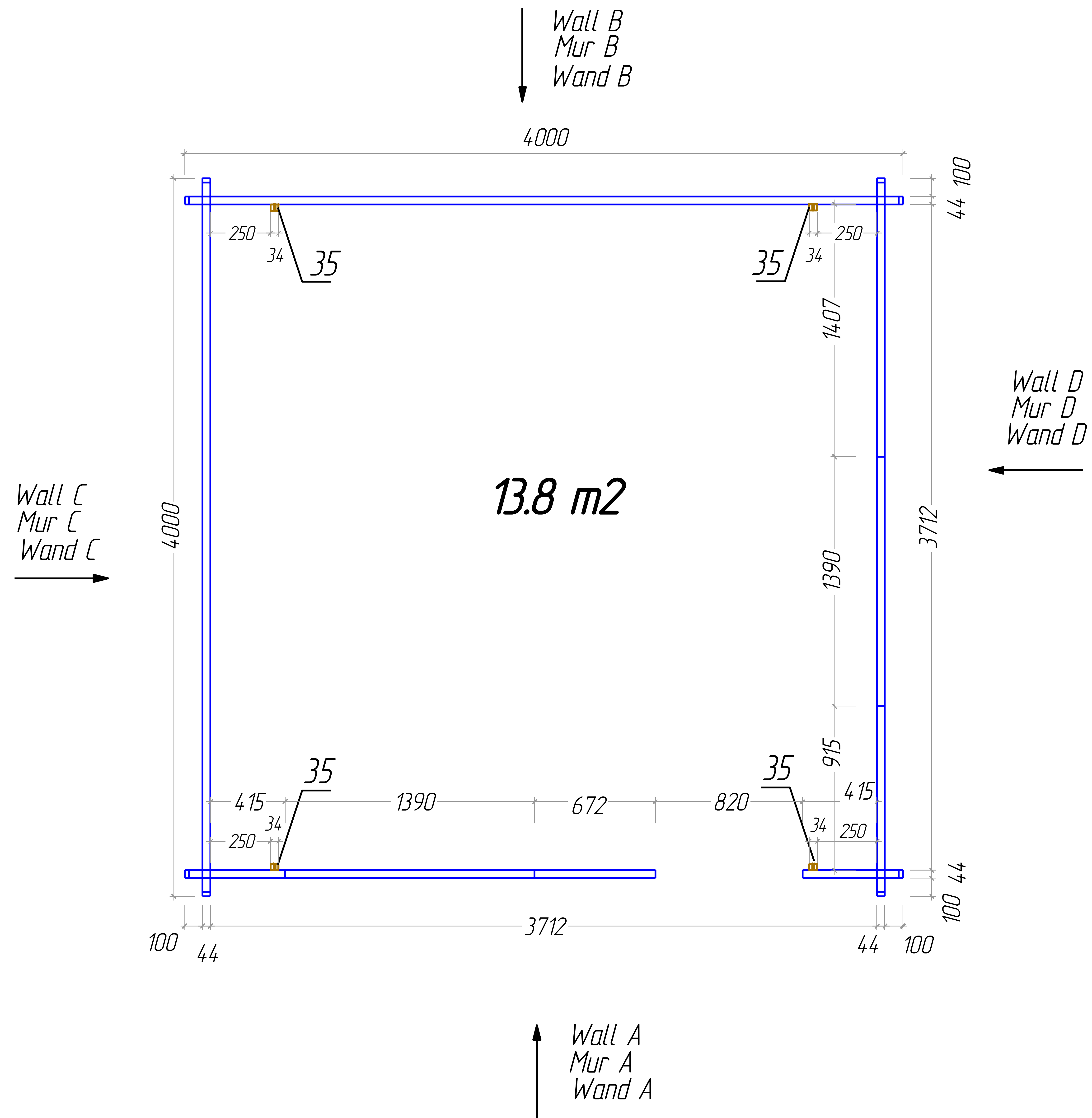

4x4

Boarding joist plan
Trummplan
Lambourde plan

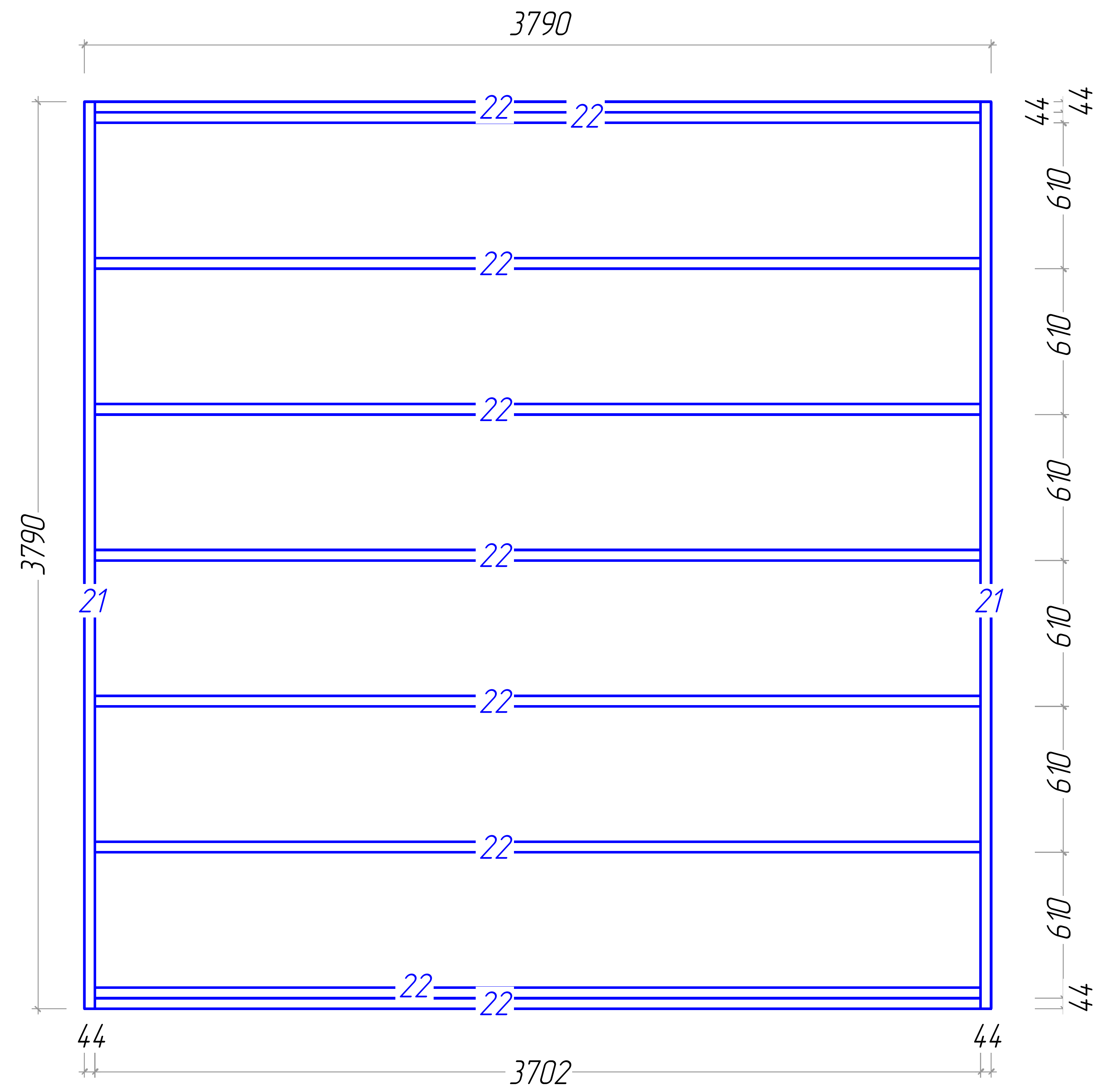

4x4

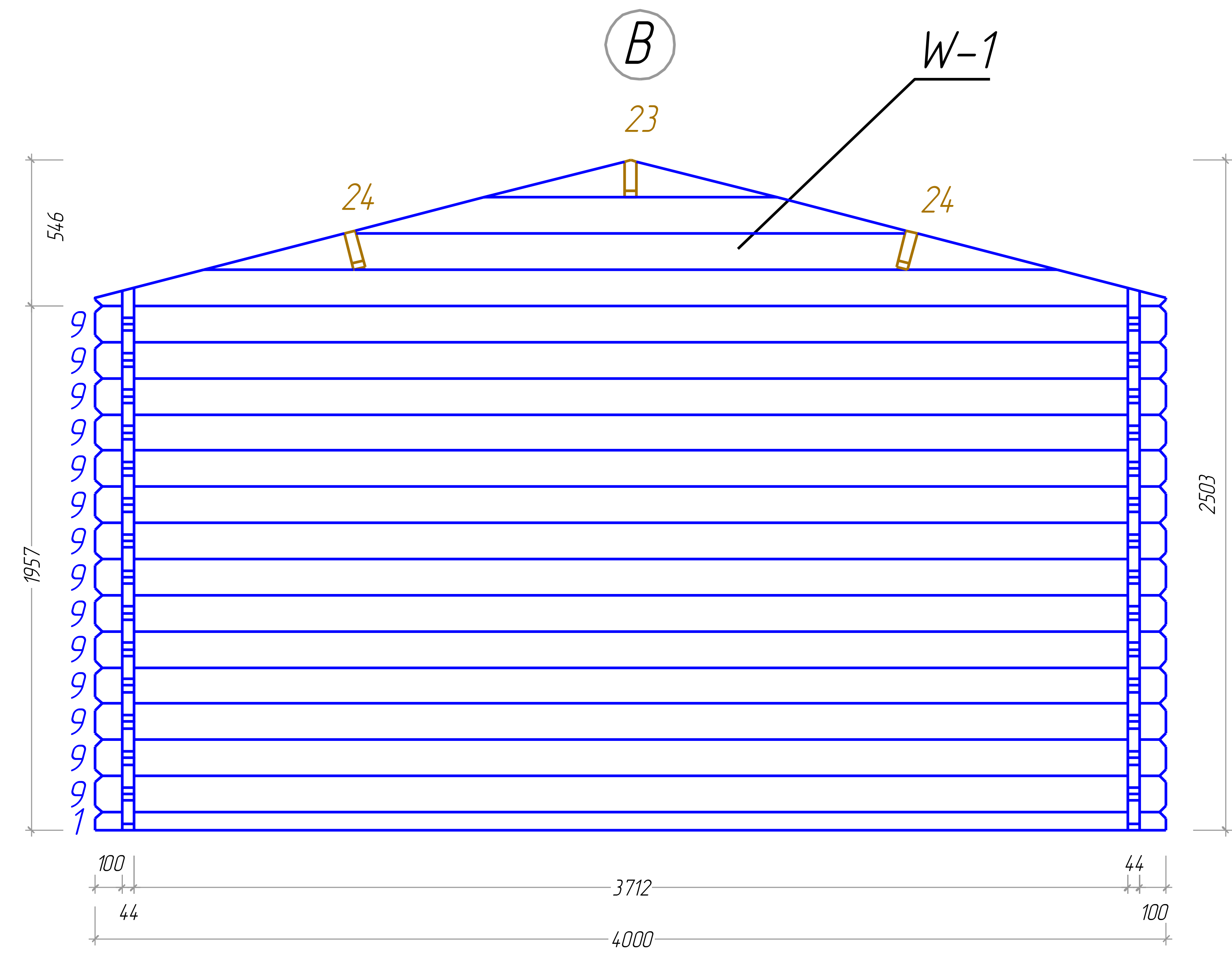
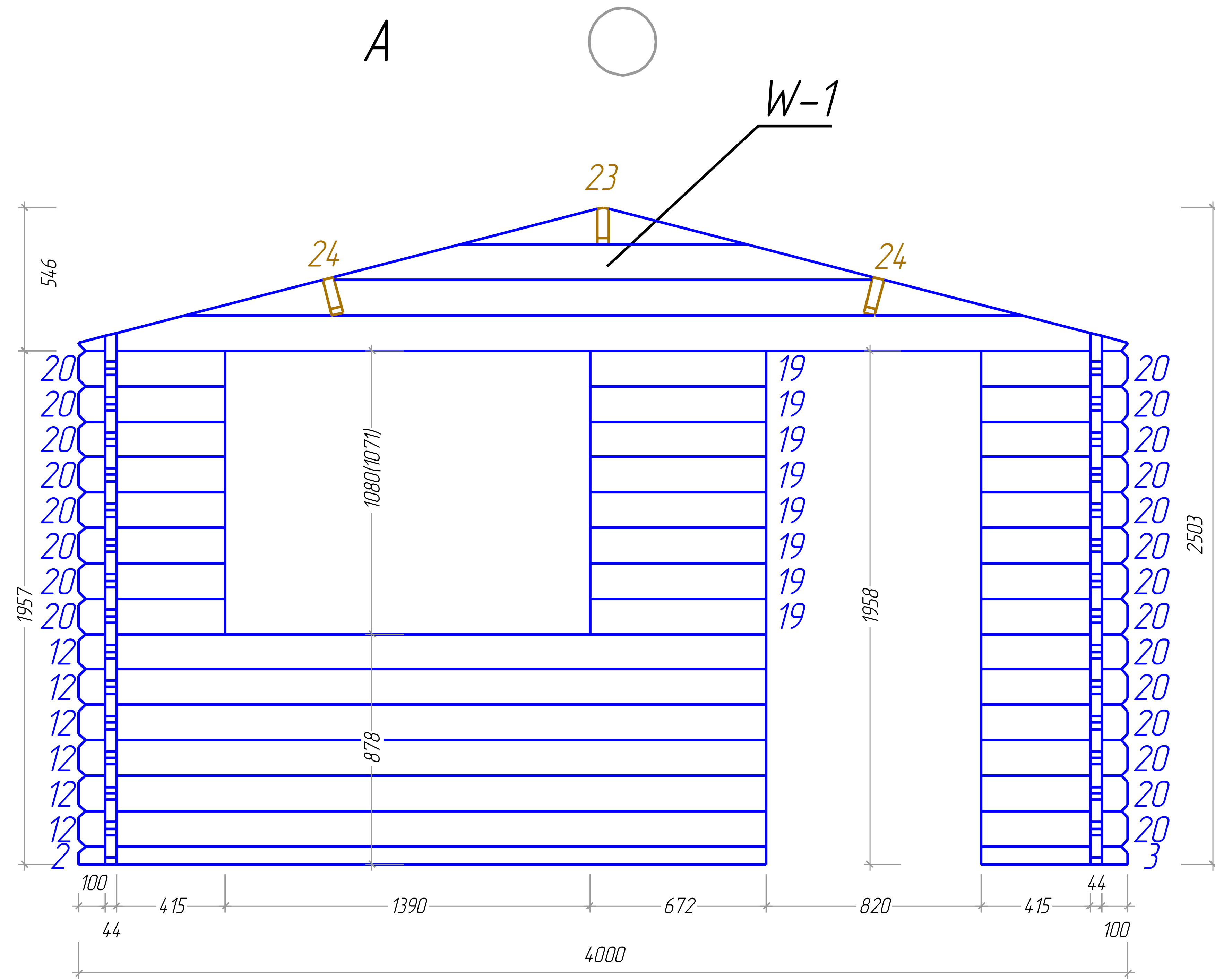

C

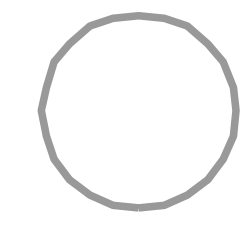

4x4

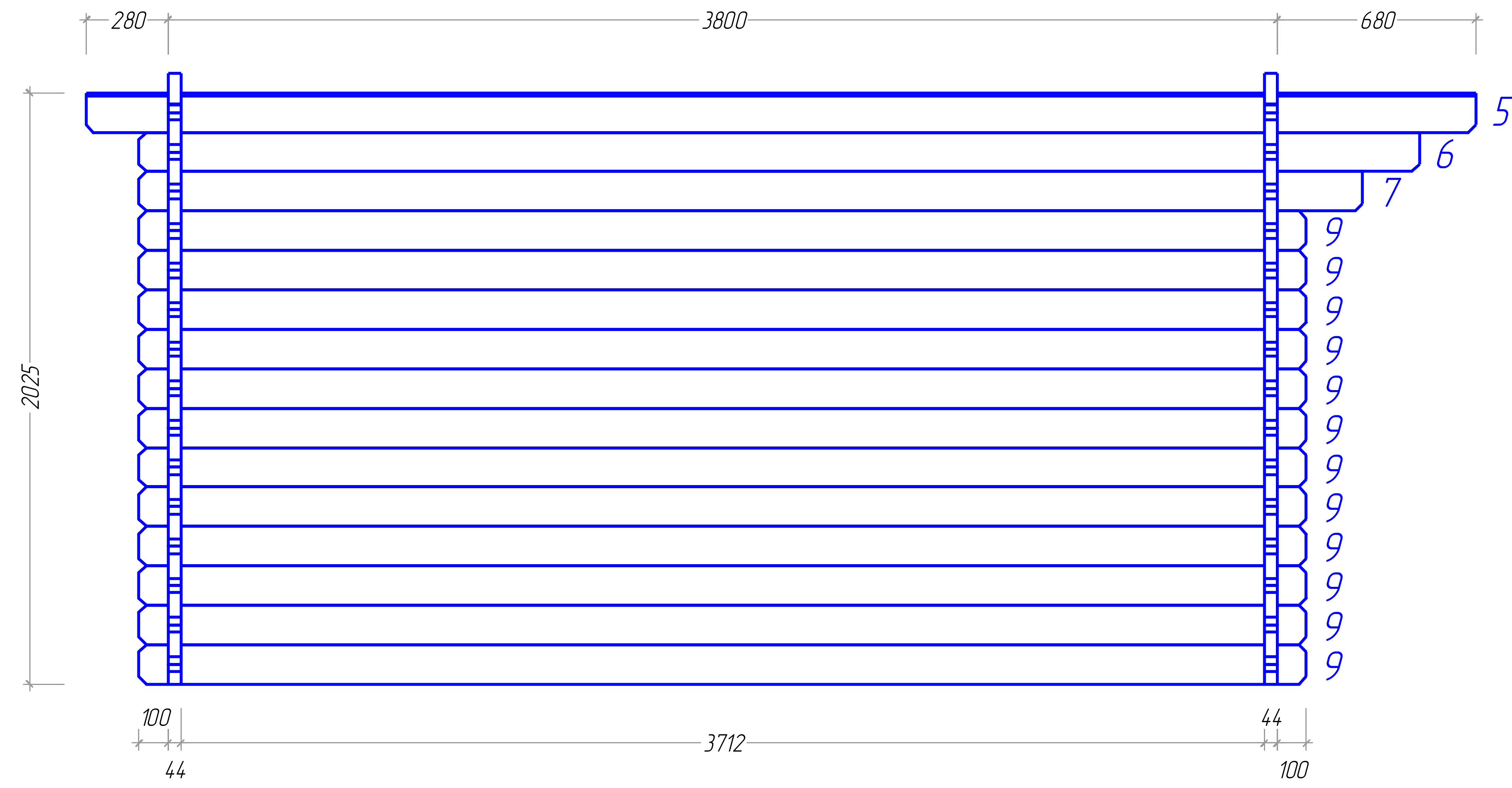

D

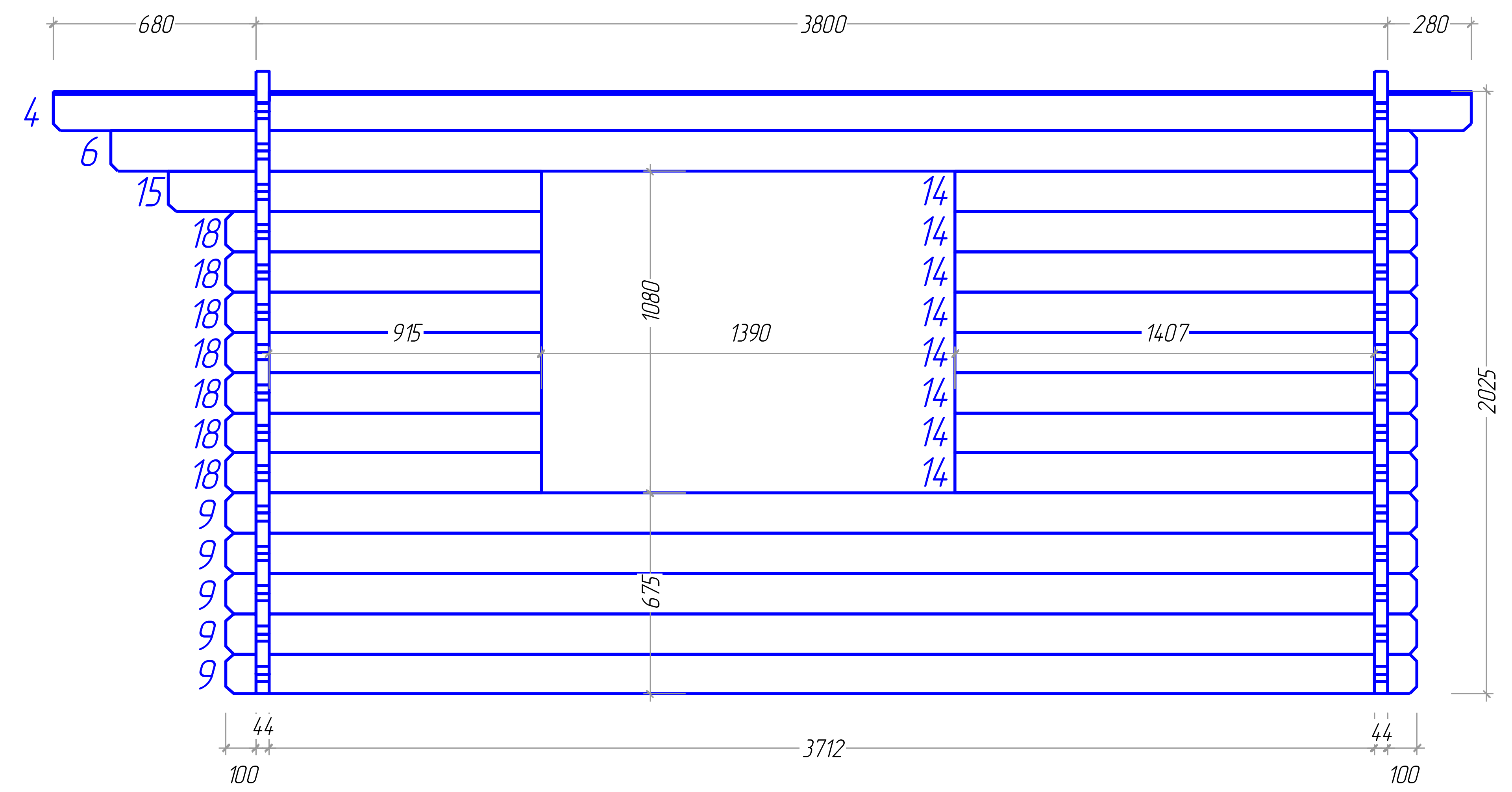

4x4

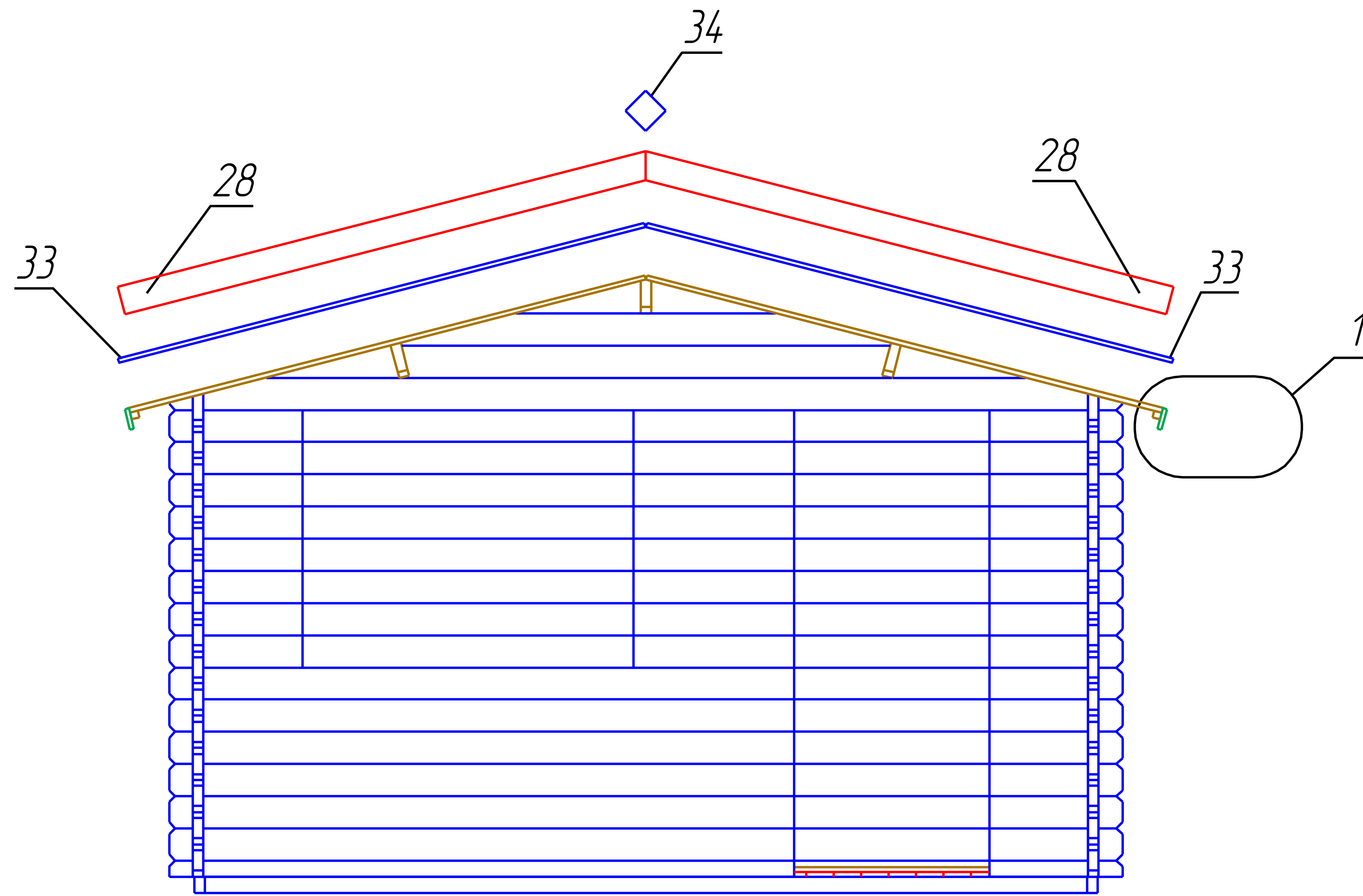

$\frac{1}{M 1:5}$

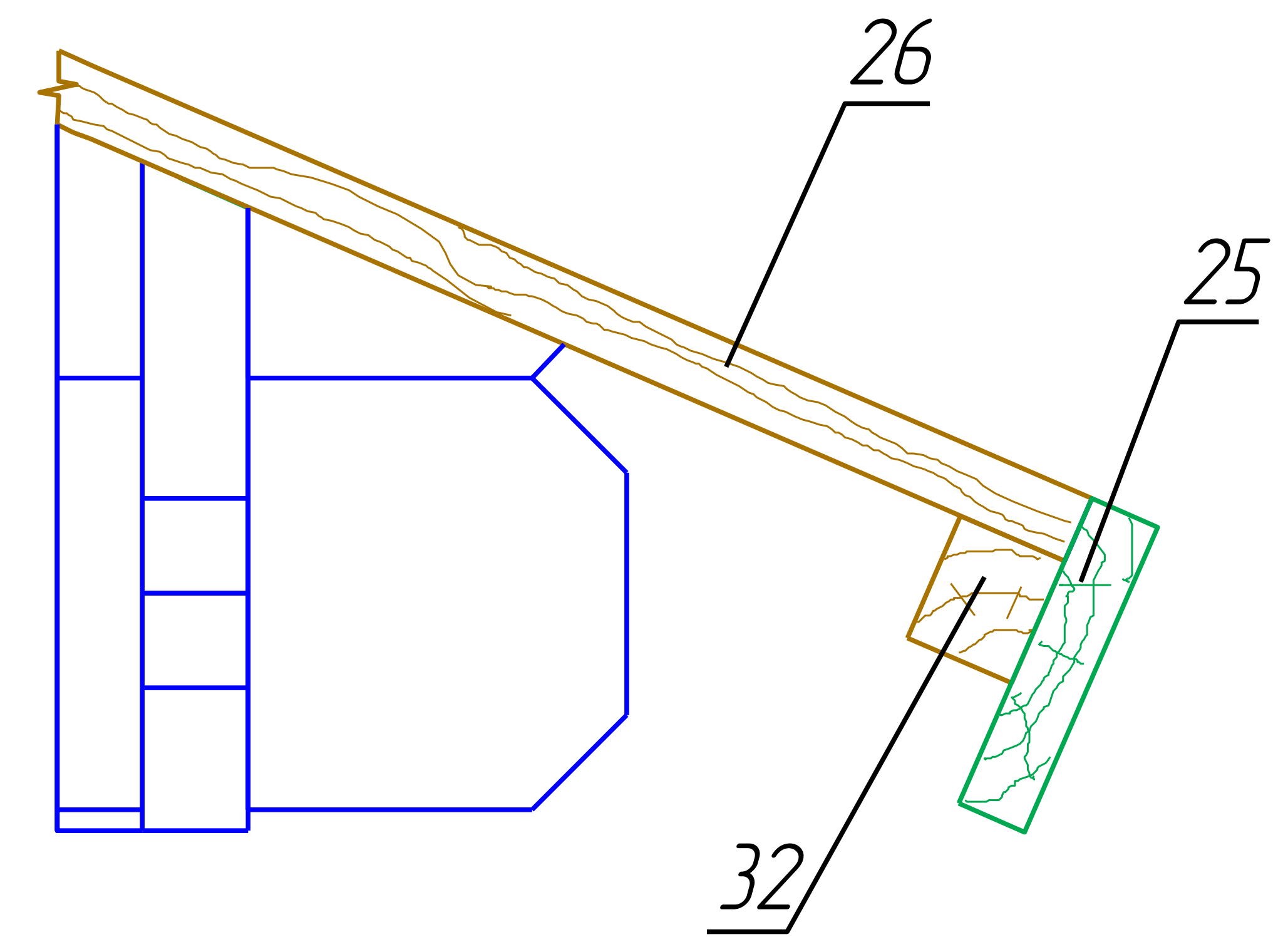

4x4

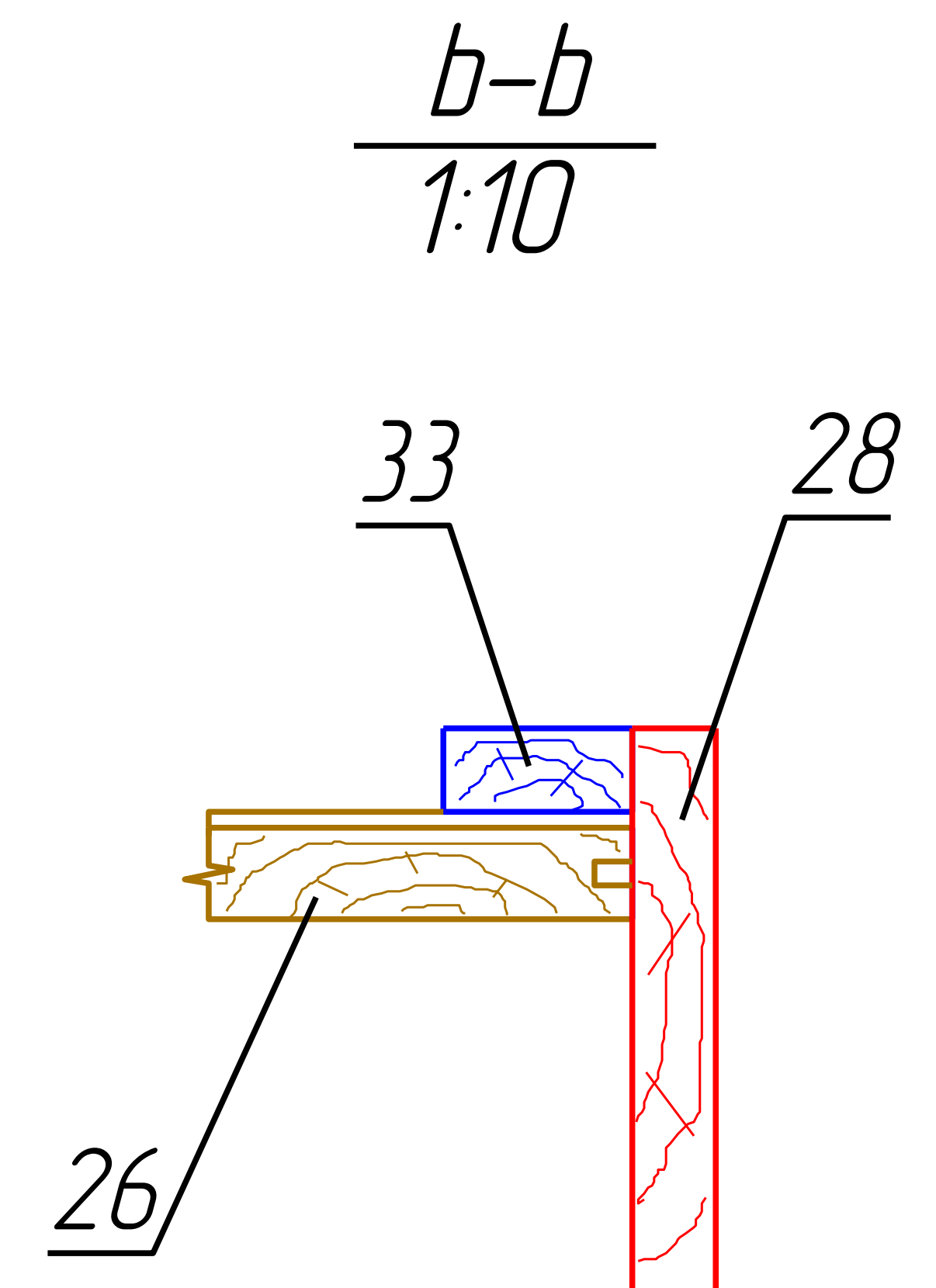
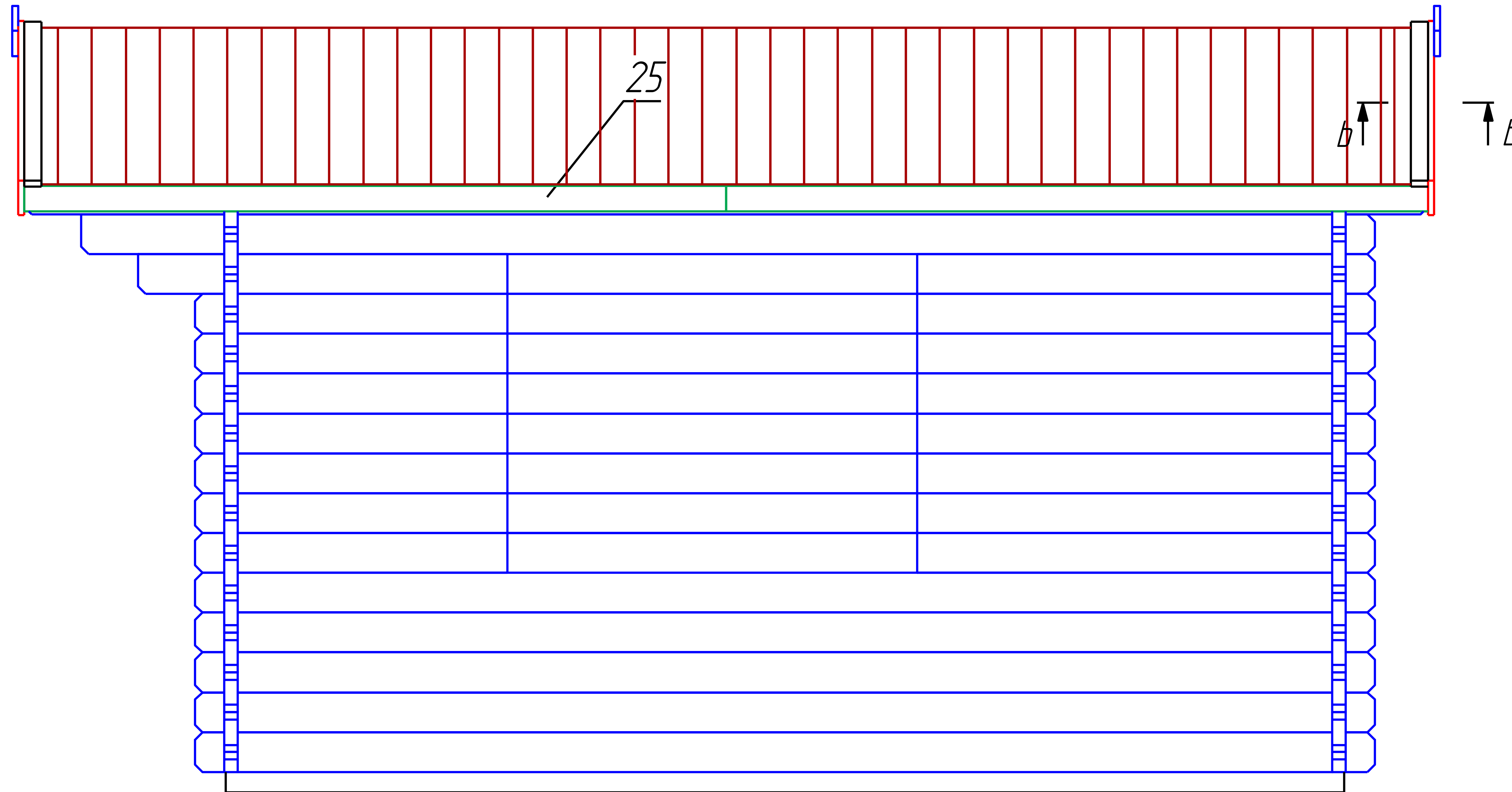

4x4

Plan of the roof board
Plan der Dachbretter
Le plan des planches du toit

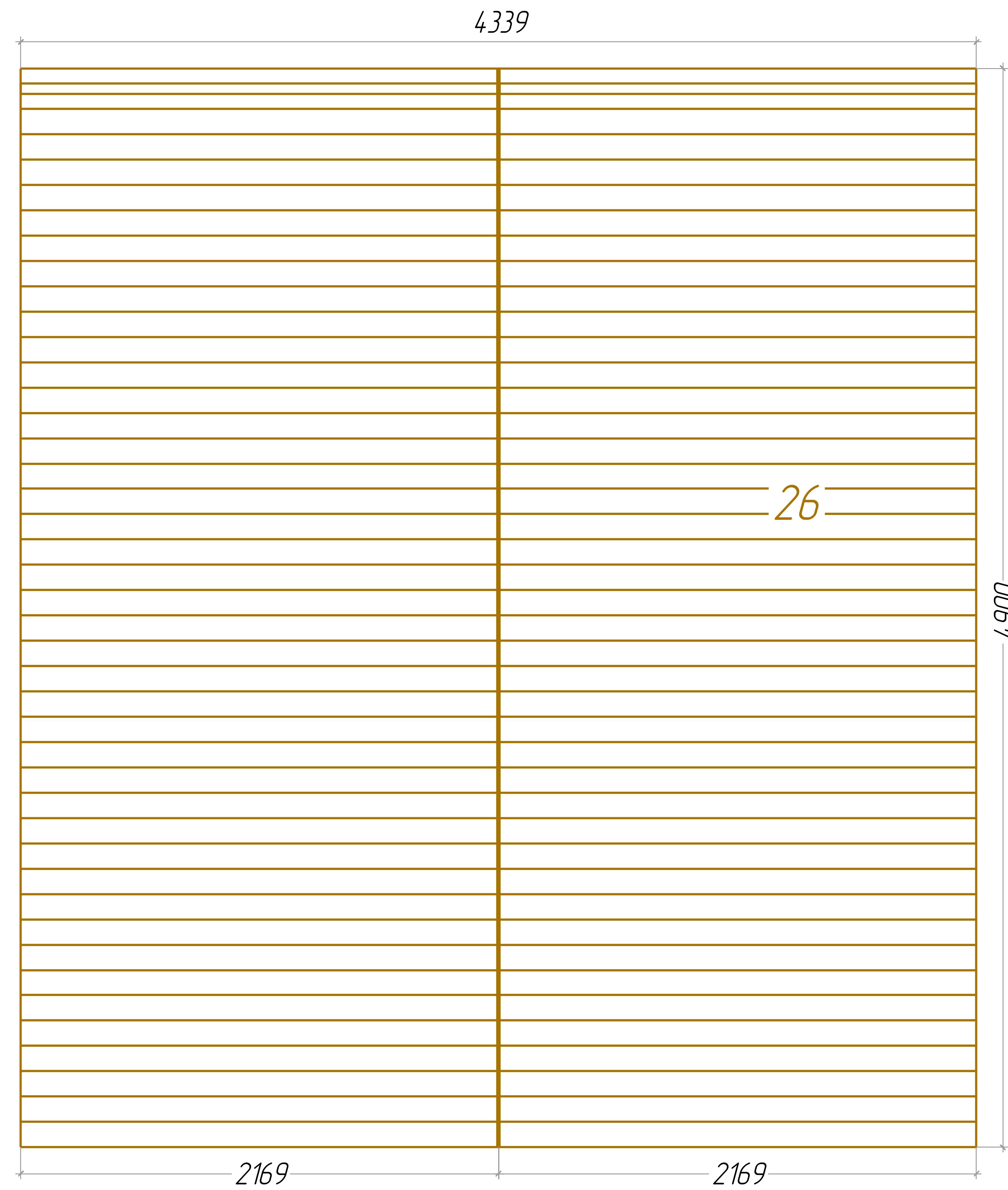





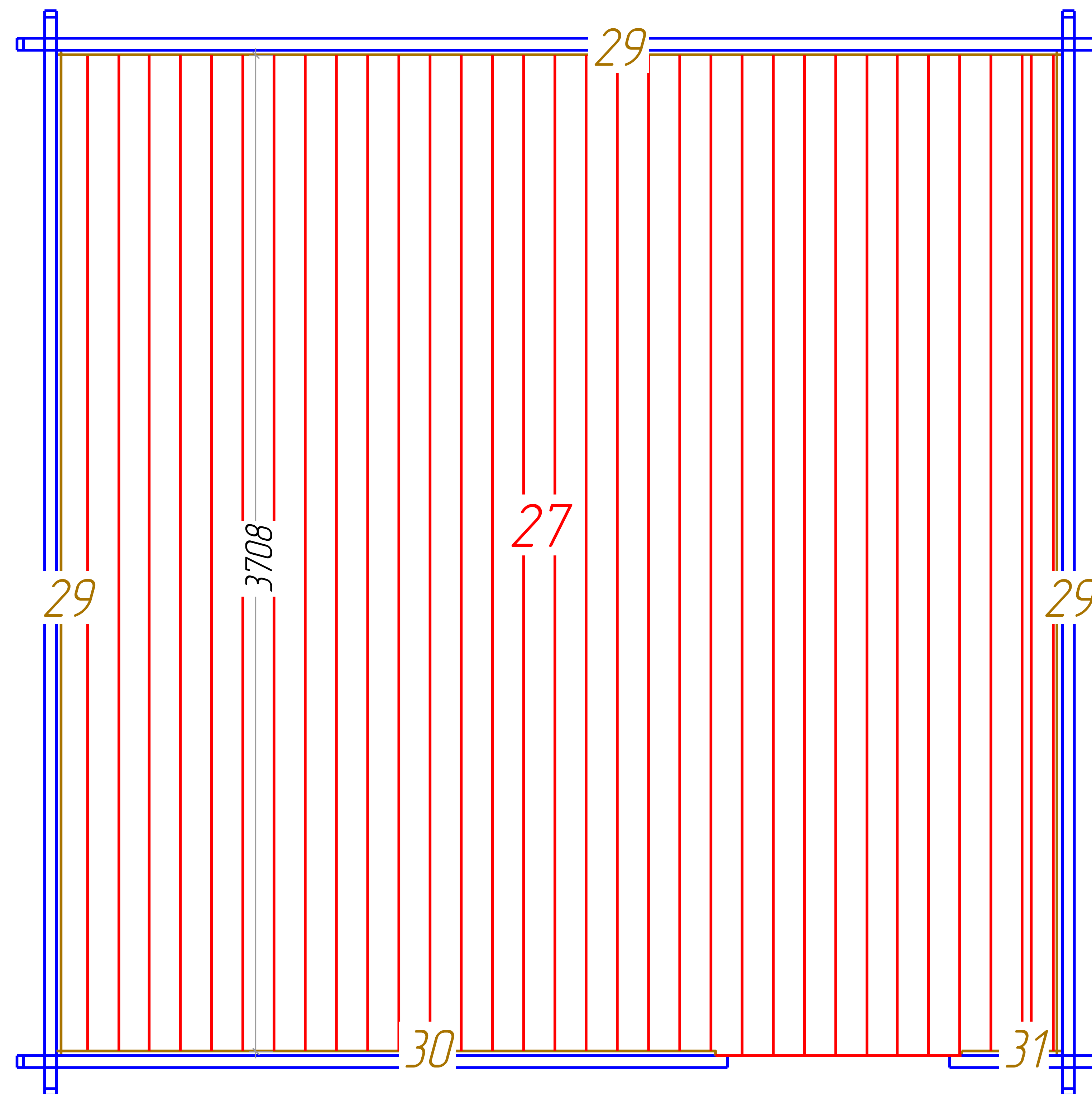

4x4

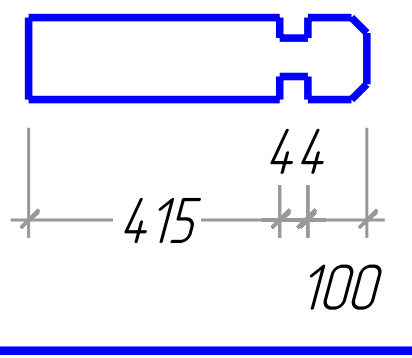
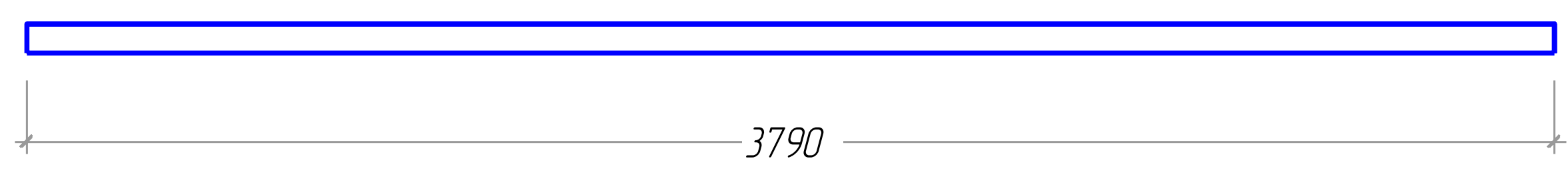
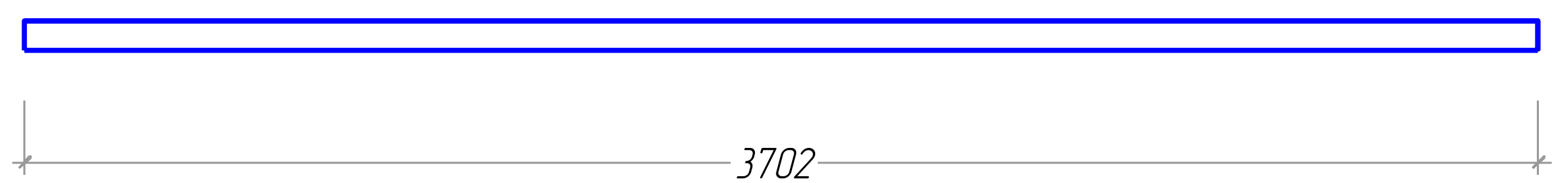
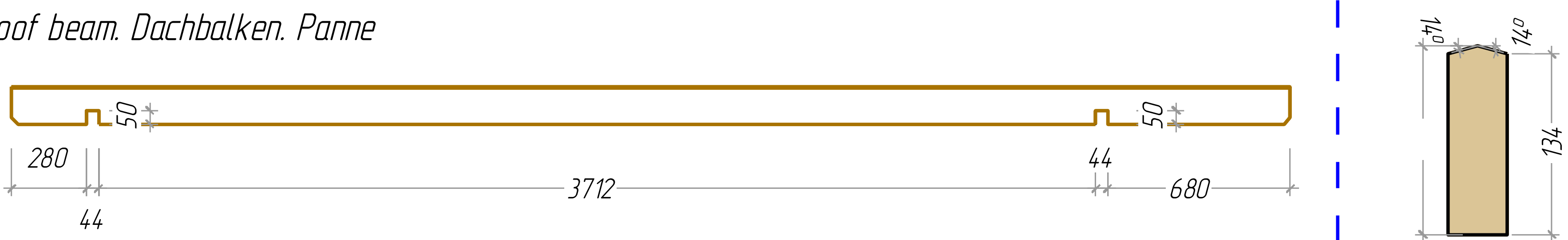
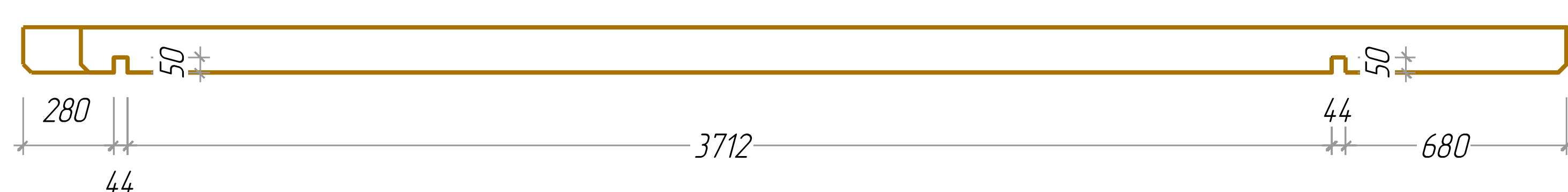
Plan of the floor board
Plan der Furbodenbretter
Le plan des plaches du plancher

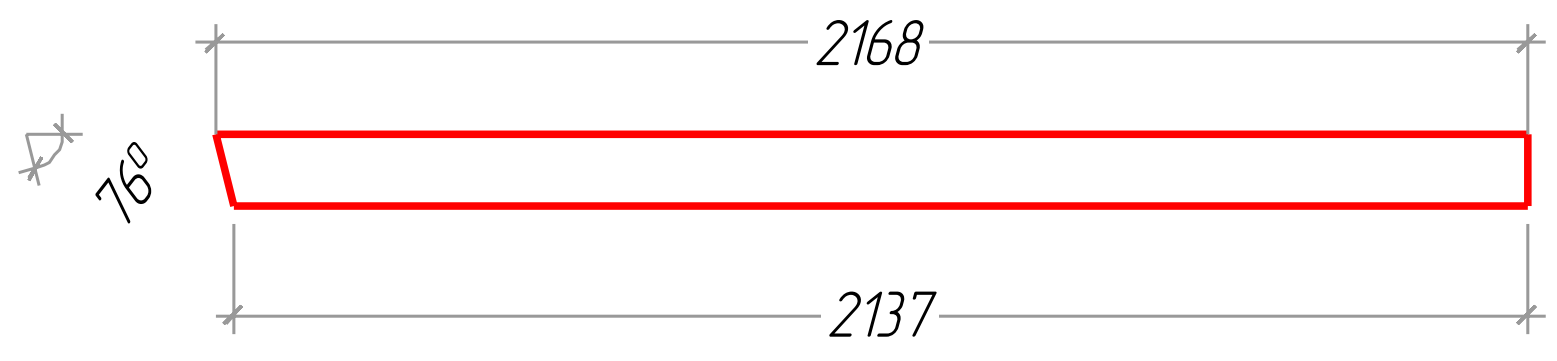
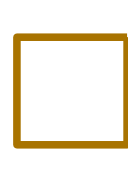
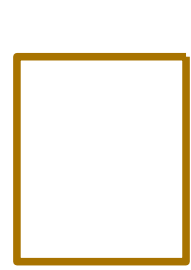

Nº		Nr.	Profile (mm)	Lenght (mm)
1		1	44x67,5	4000mm
2		1	44x67,5	2621mm
3		1	44x67,5	559mm
4		1	44x135	4760mm
5		1	44x135	4760mm
6		2	44x135	4387mm
7		1	44x135	4193mm
9		31+1	44x135	4000mm
12		6	44x135	2621mm
14		8	44x135	1551mm
15		1	44x135	1252mm
18		7	44x135	1059mm
19		8	44x135	672mm

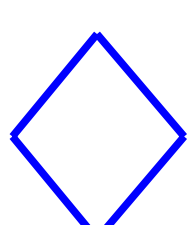
Nº		Nr.	Profile (mm)	Lenght (mm)
20		22	44x135	559mm
21	Foundation Fundament Solive 	2	44x68	3790mm
22	Foundation Fundament Solive 	9	44x68	3702mm
23	Roof beam. Dachbalken. Panne 	1	44x140	4760mm
24	Roof beam. Dachbalken. Panne 	2	44x140	4760mm
25	Roof side boards Traufenbrett Planche de rive 	4	18x90	2380mm
26	Roof boards. Dachbretter Volige 	84+1	20x115	2130mm
27	Floor boards Fu ssboden Lame de plancher 	33+1	20x115	3708mm
28	Fascia board Giebelblende Planch de rive facade 	4	20x120	2168mm
29	Floor edge trim Fu bleisten Plinthe plancher 	3	20x18	3712mm
30		1		2434mm
31		1		372mm
32	Roof edge reinforcement Traufleisteu Tasseau 	6	28x34	1587 mm
33	Roofing felt fillet Giebelabschlussbrett Latte de finition couverture 	4	20x58	2160mm
34	Diamond Raute Diamant 	2	T. 20	120mm

N ^o		Nr.	Profile (mm)	Lenght (mm)
W-1		2		
	<p>Door Tur La porte</p>	1		
	<p>Window Fenetre Fenster</p>	2		
35				

Storm protection

