

Elvis 34 5,6x2,5

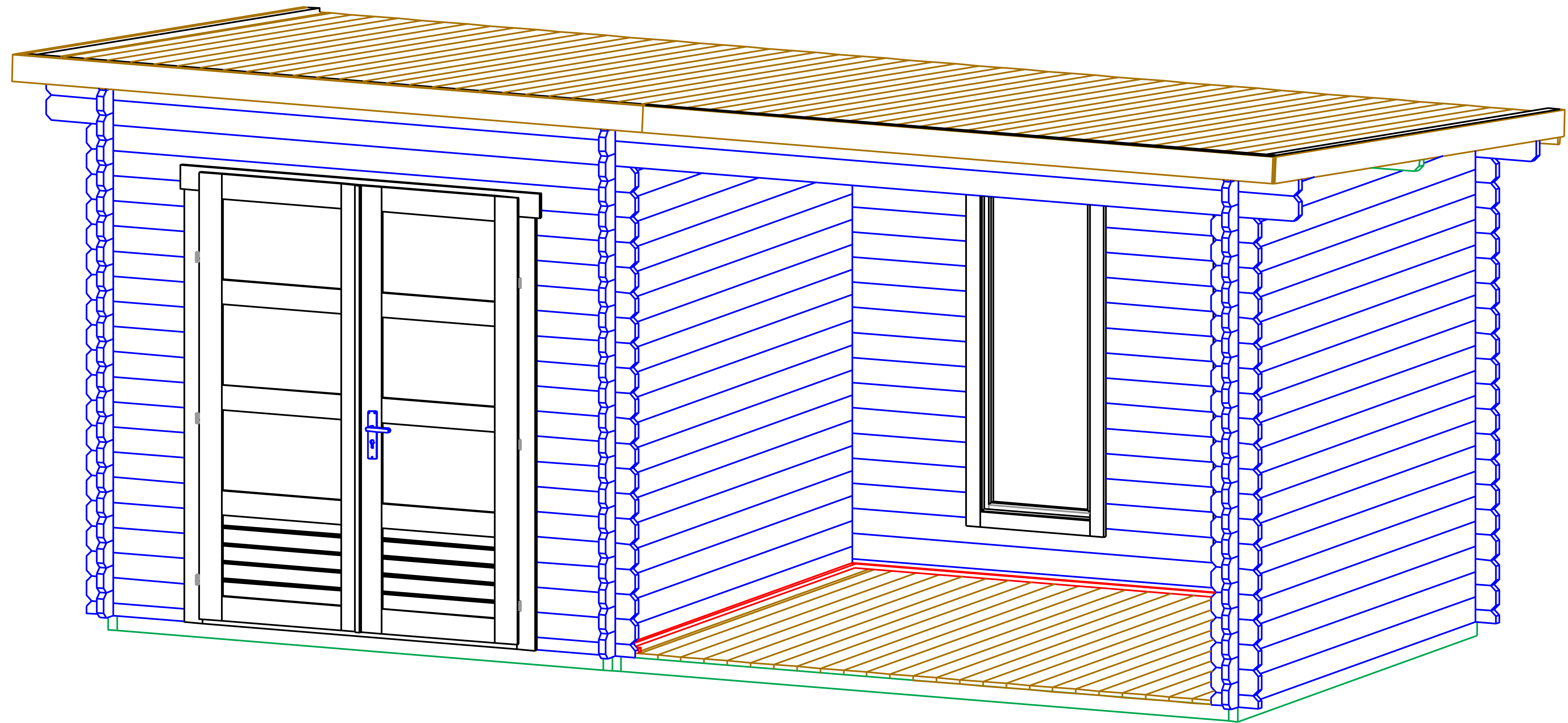

Elvis 34 5,6x2,5

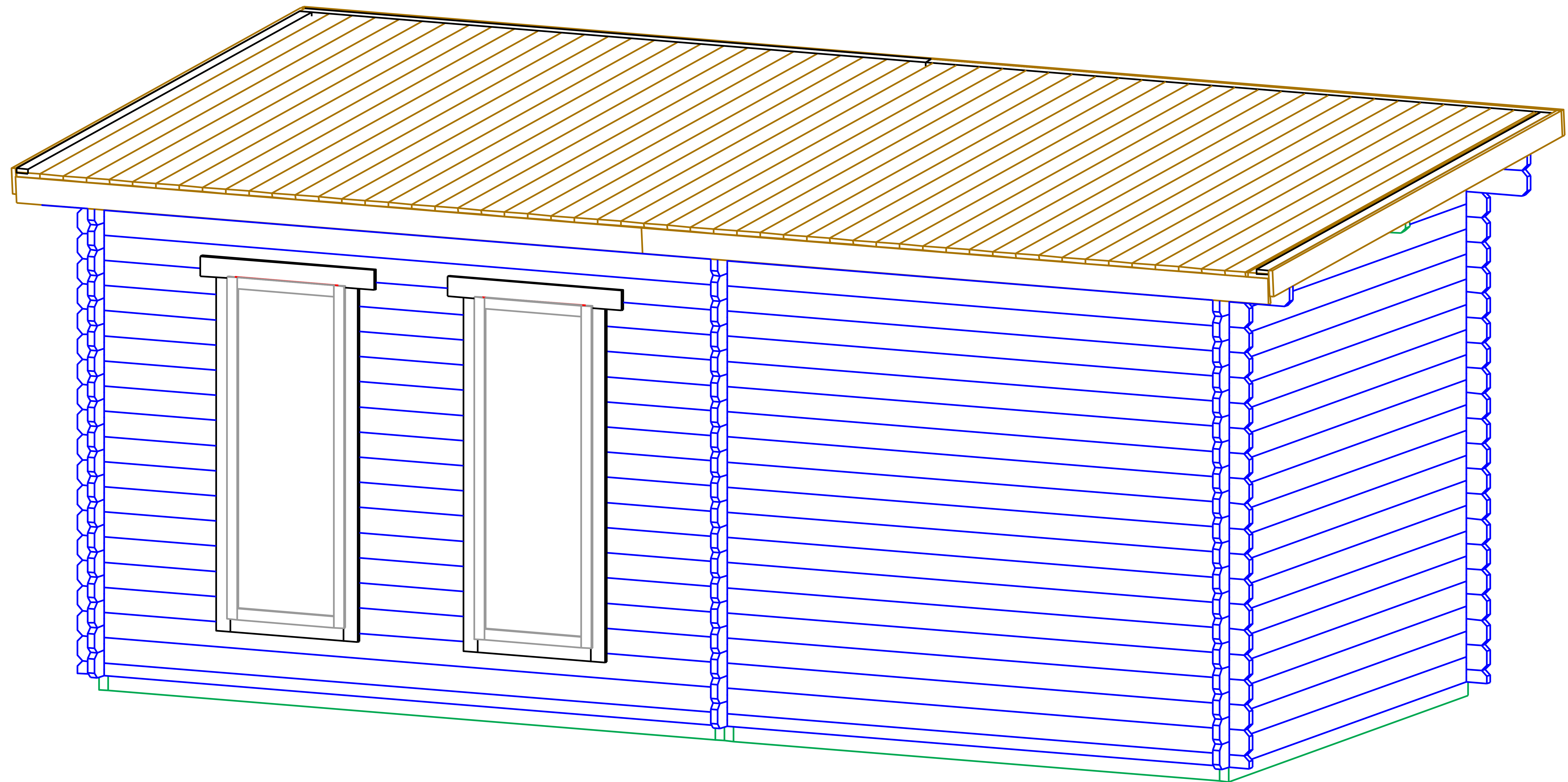

Elvis 34 5,6x2,5

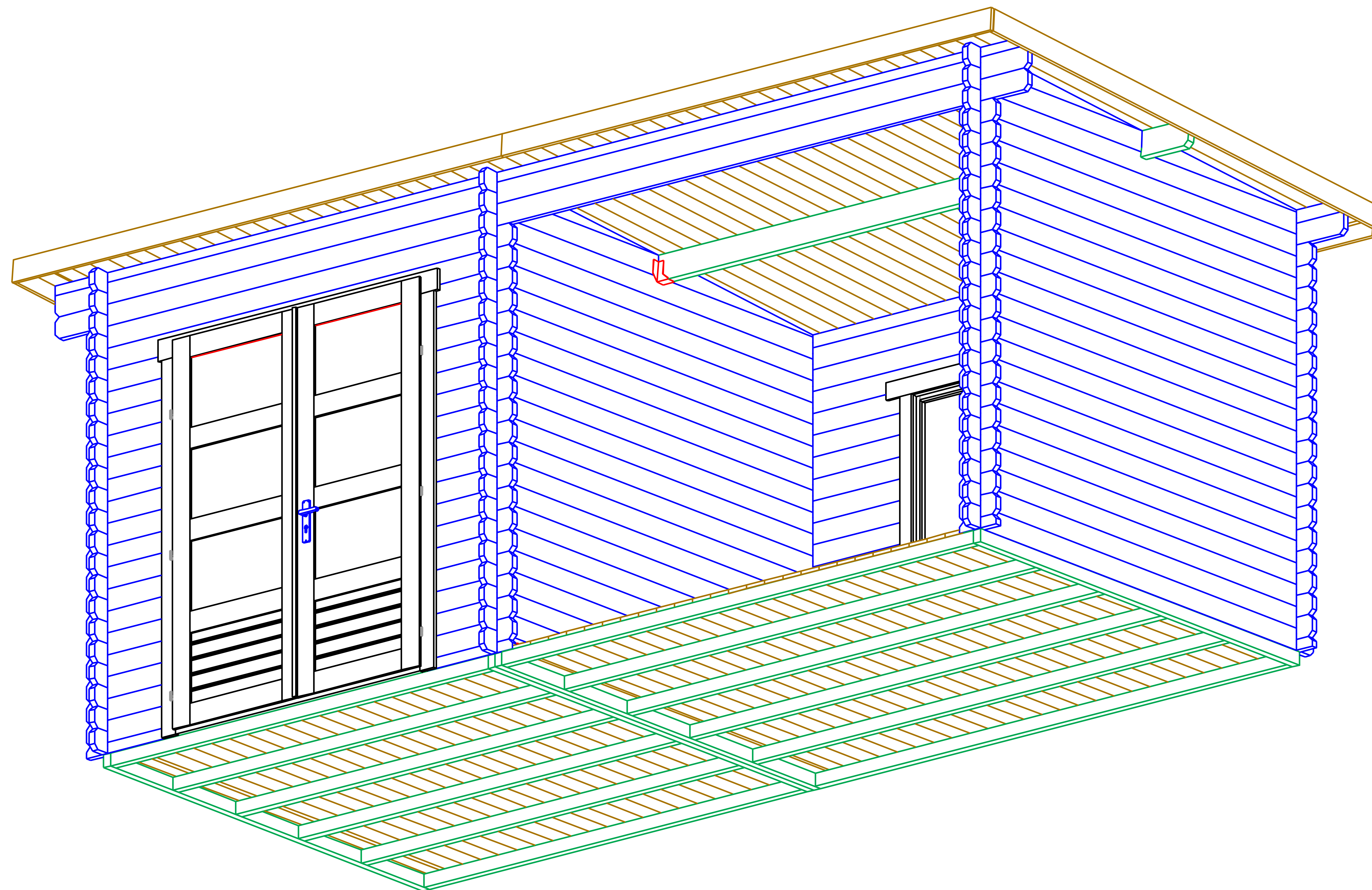

Elvis 34 5,6x2,5
Plan

Стена B
Wand B
Wall B
Mur B
↓

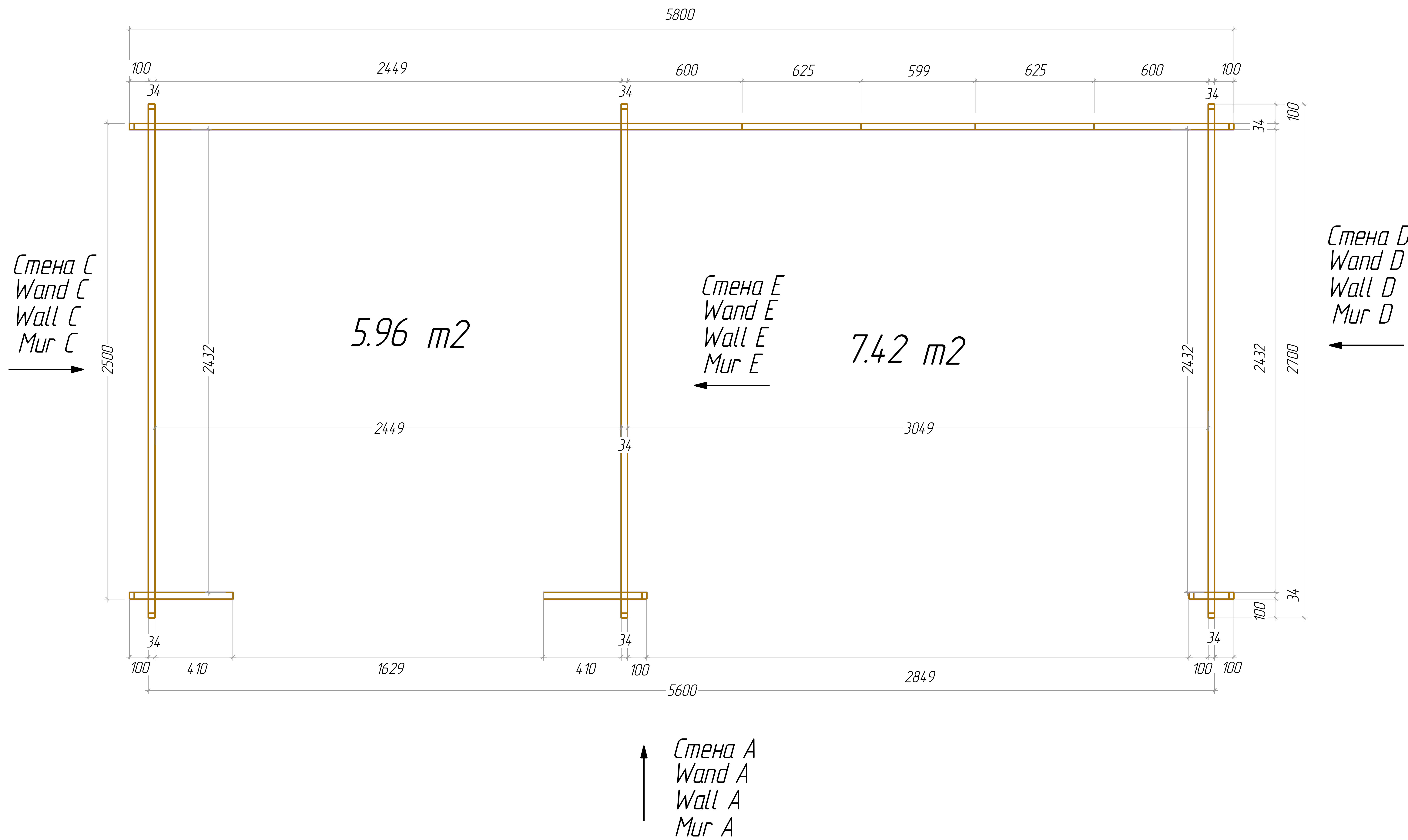

Elvis 34 5,6x2,5

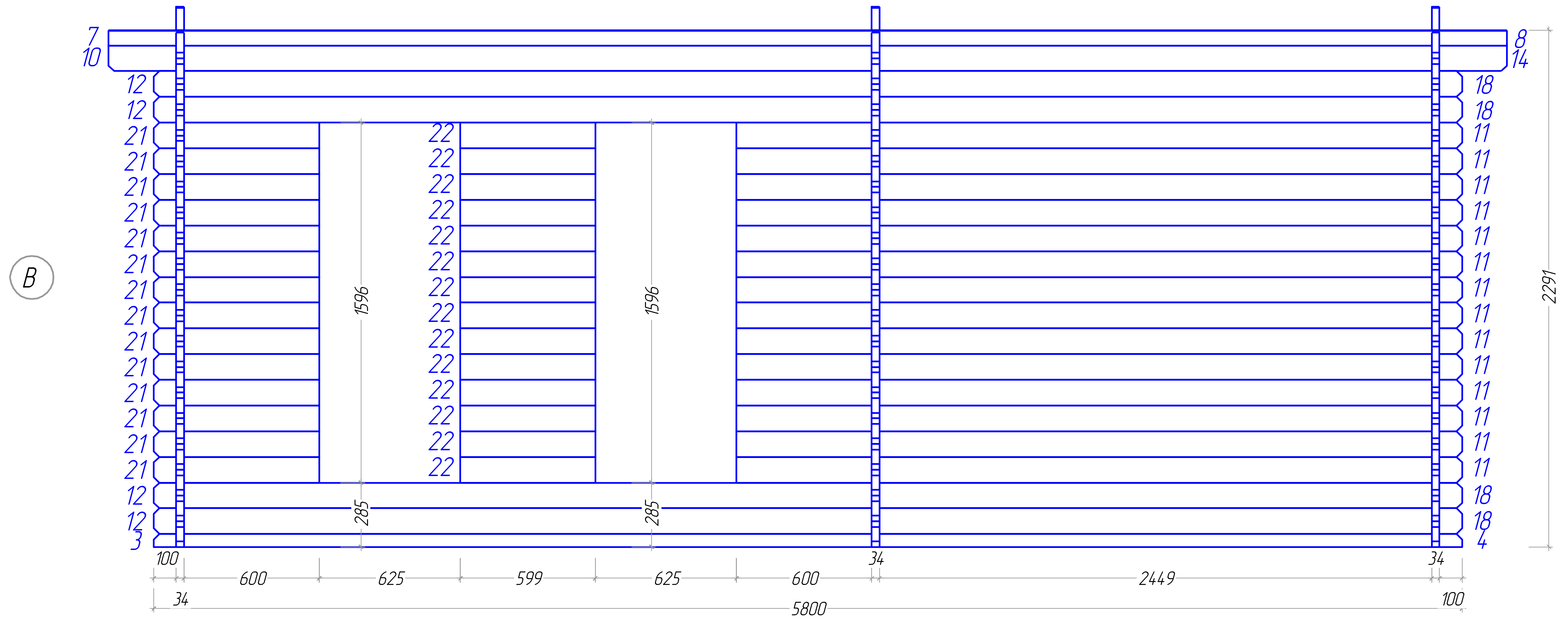
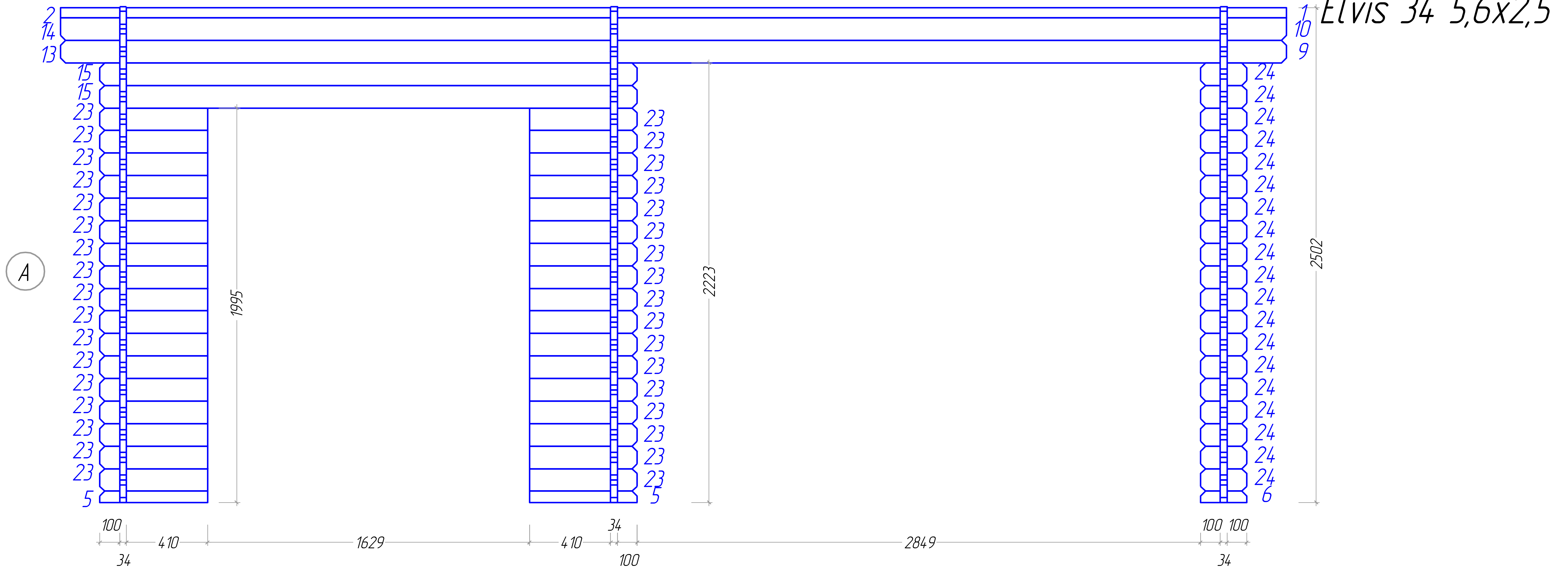

Elvis 34 5,6x2,5

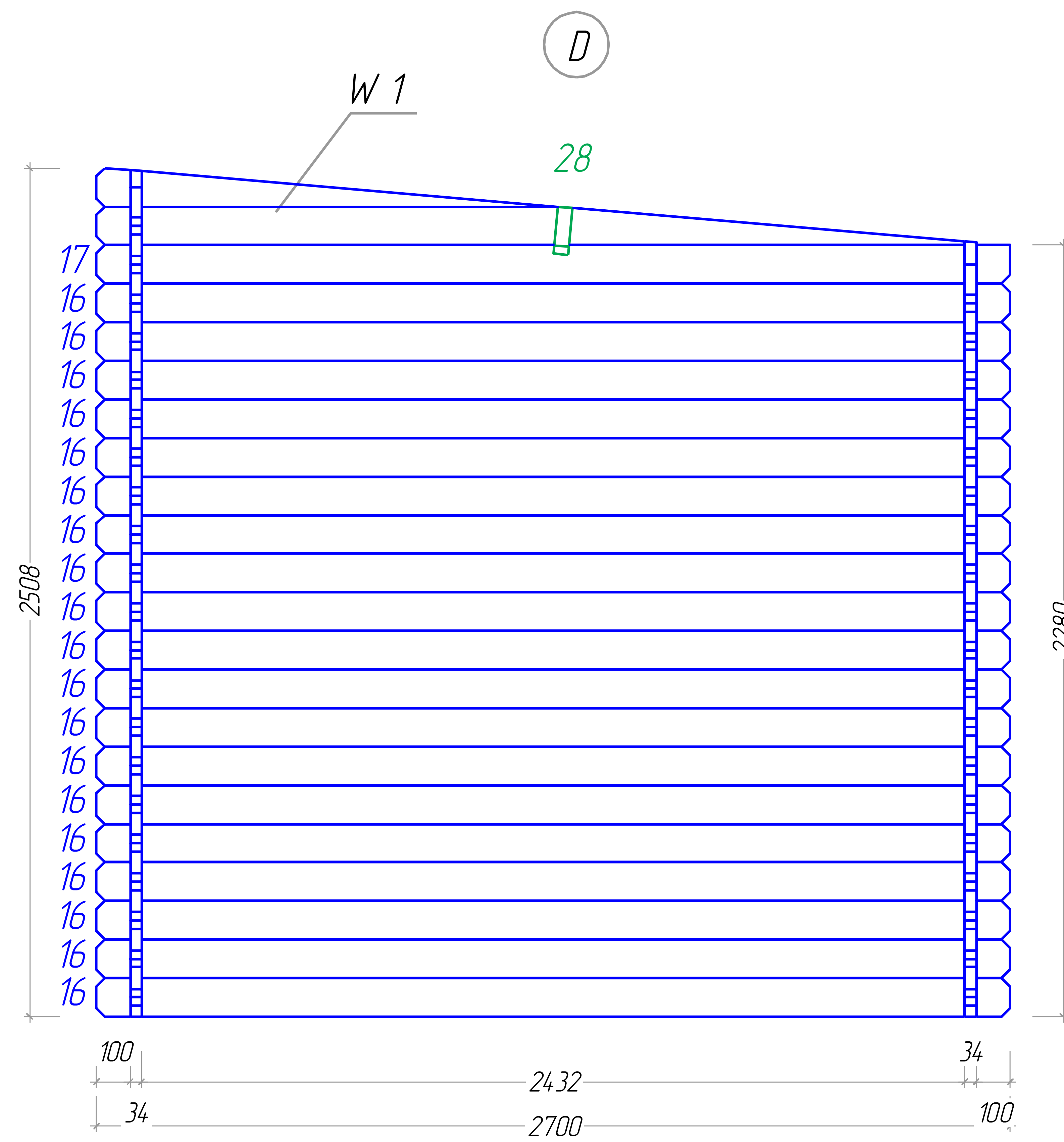
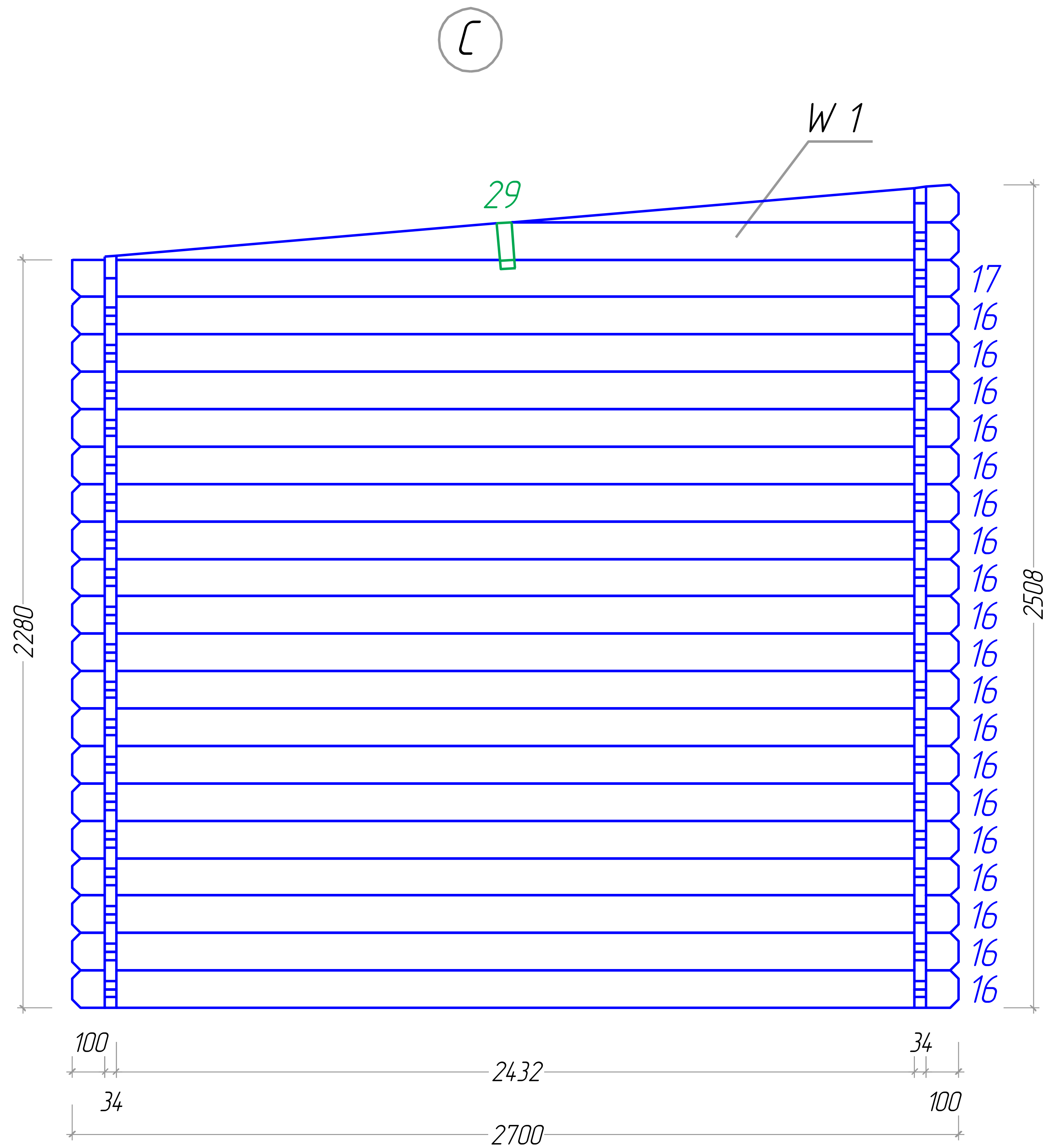

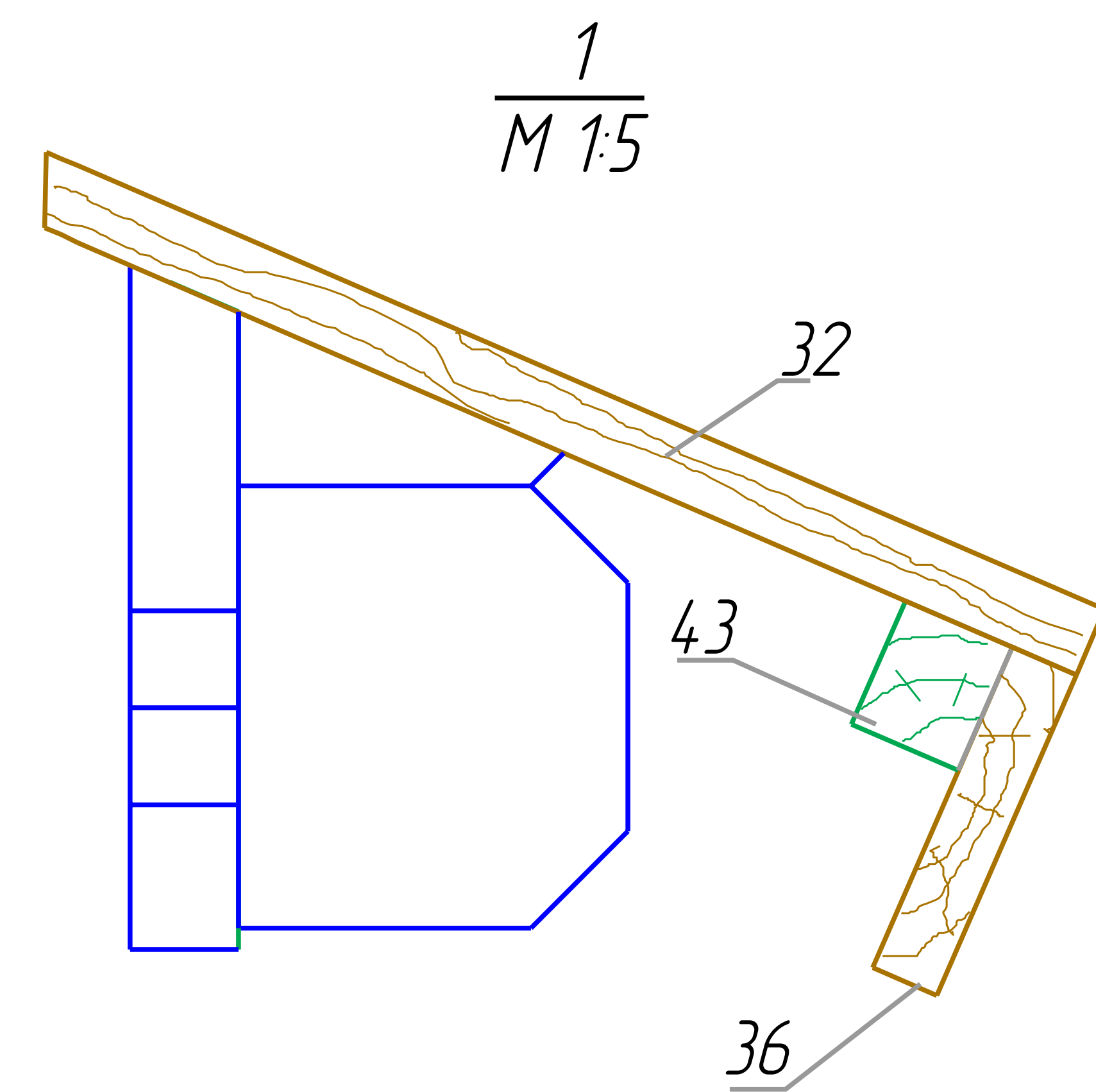
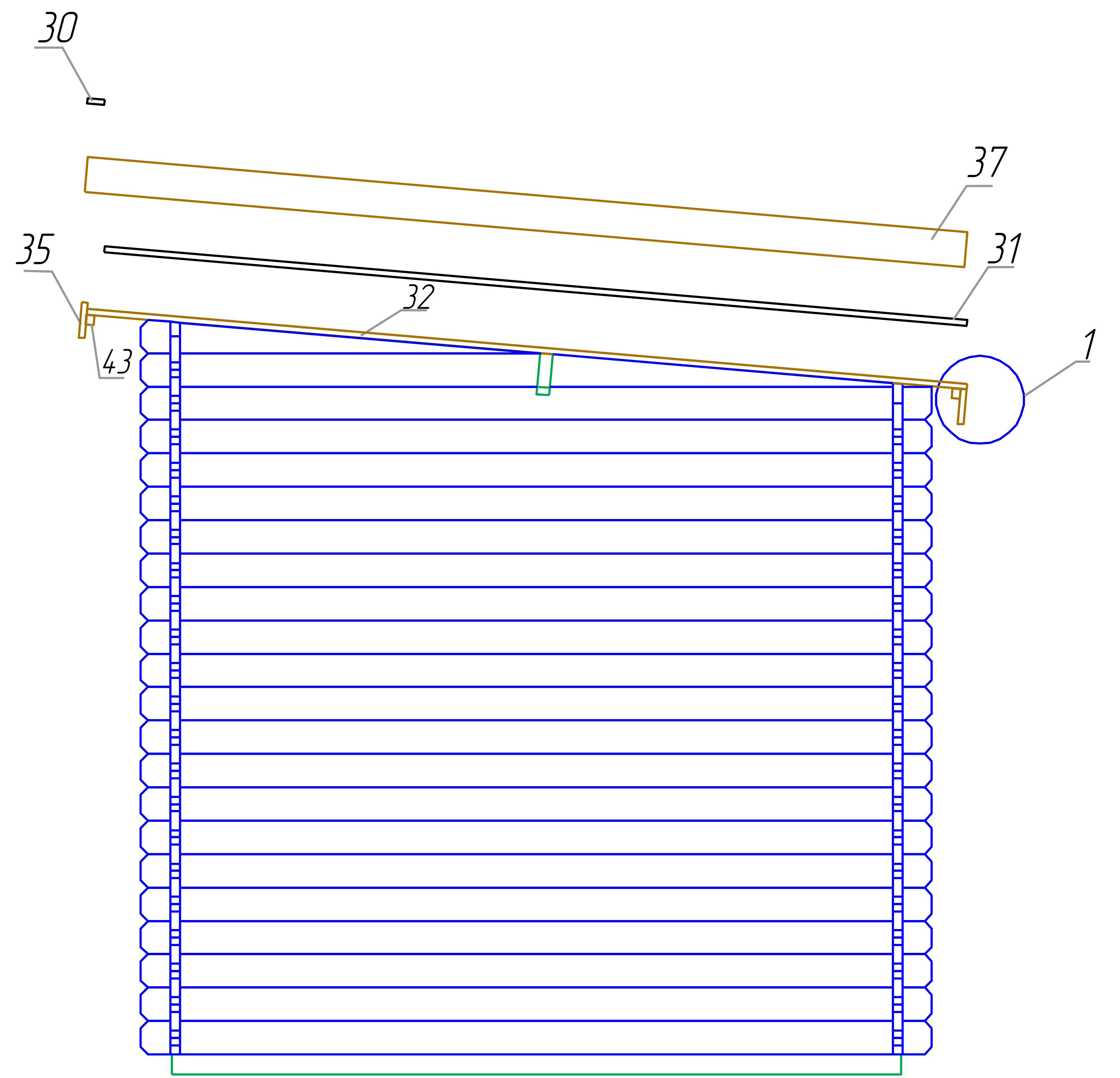
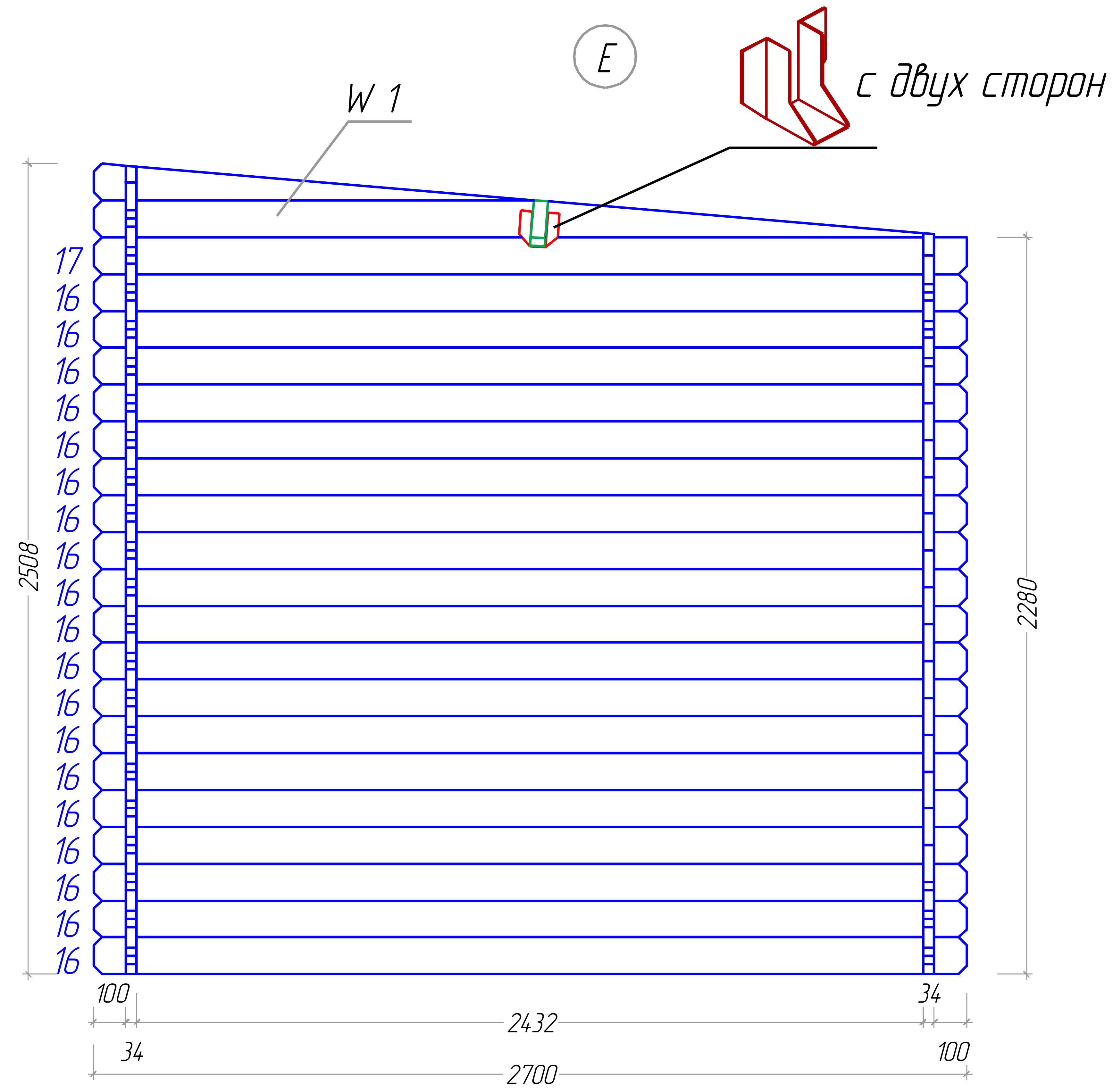

Elvis 34 5,6x2,5

Boarding joist plan

Trummplan

Lambourde plan

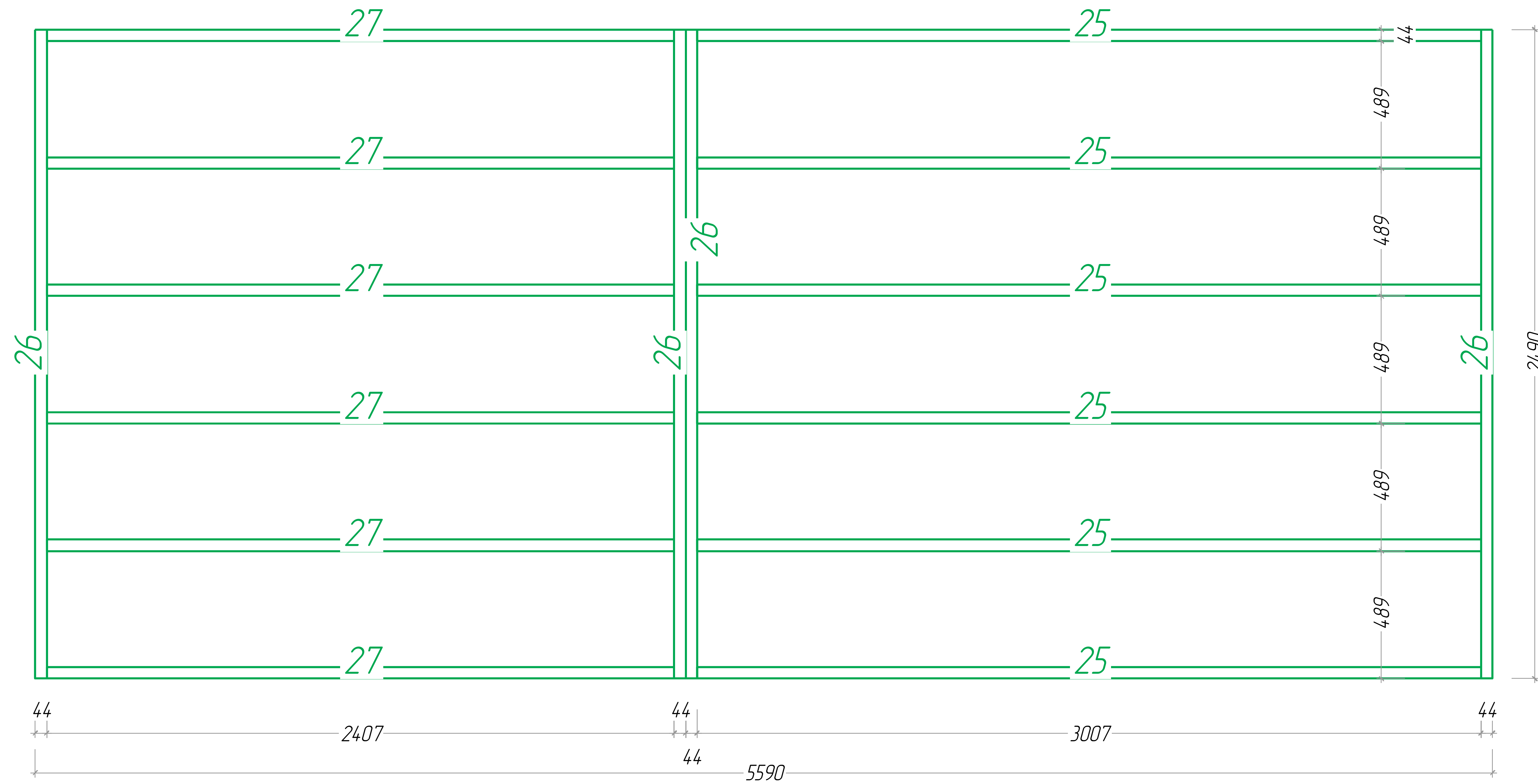

Elvis 34 5,6x2,5

Plan of the floor board

Plan der Furbodenbretter

Le plan des plaches du plancher

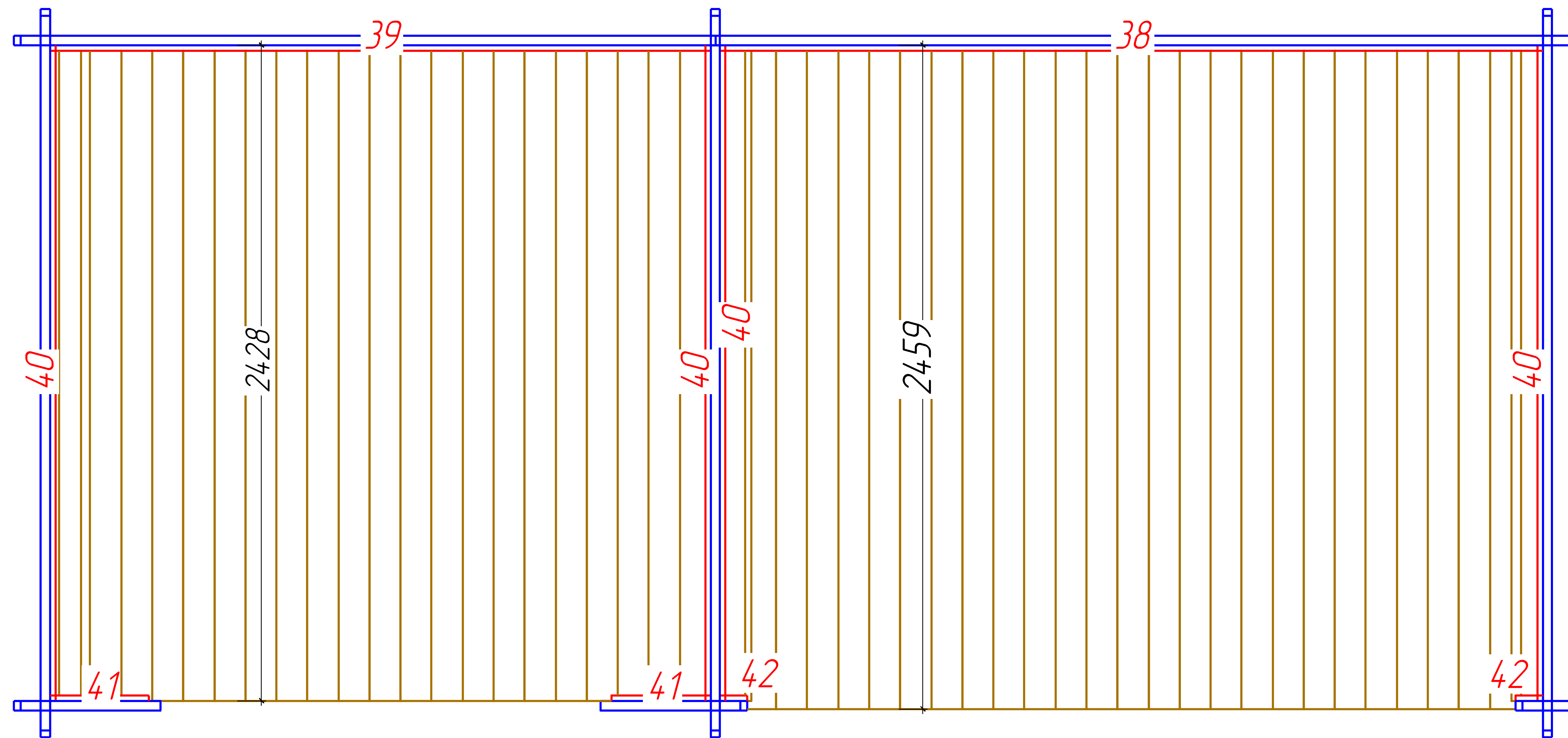

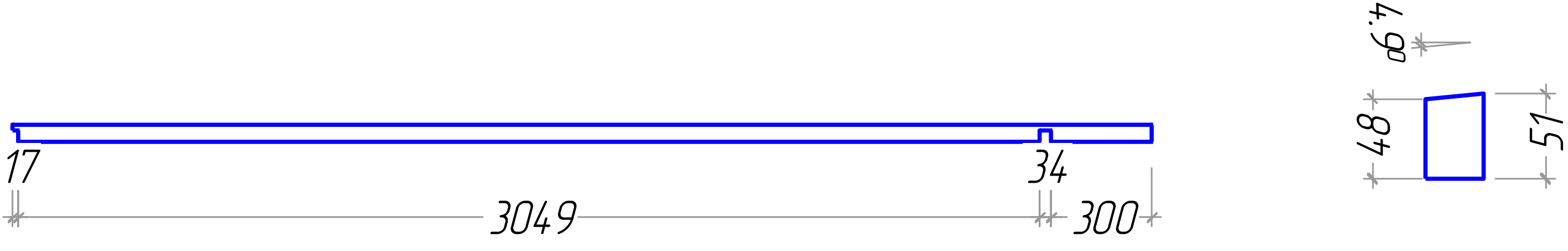
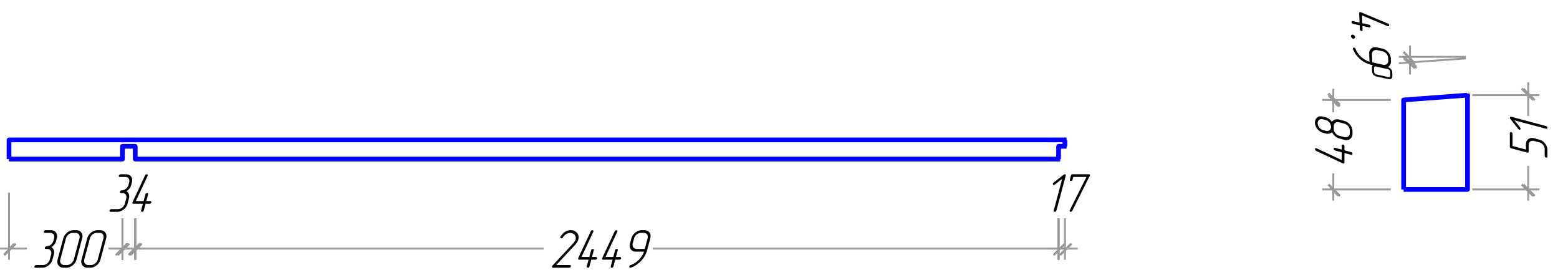
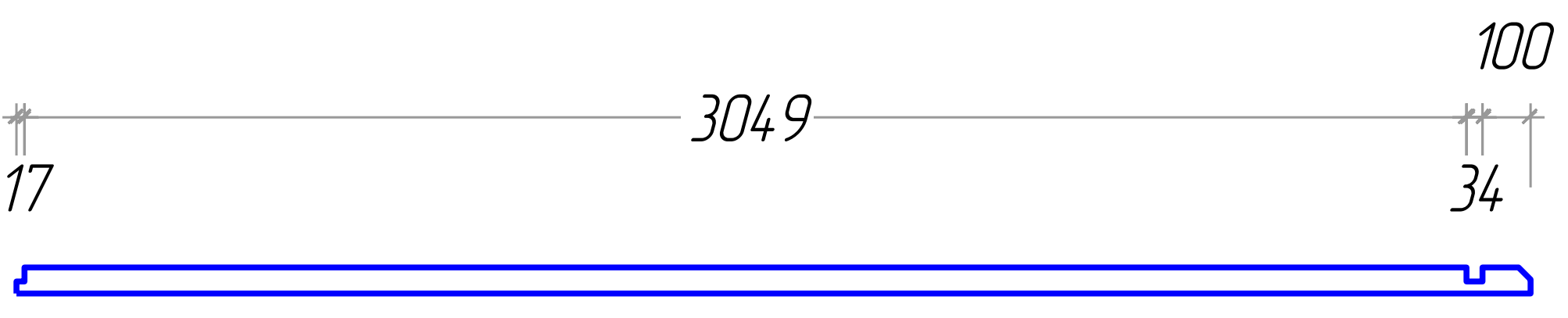
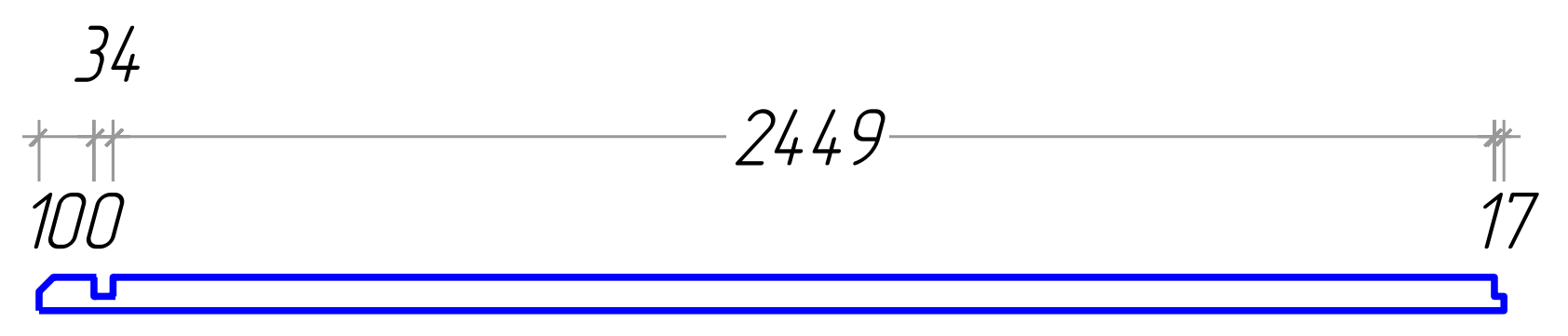
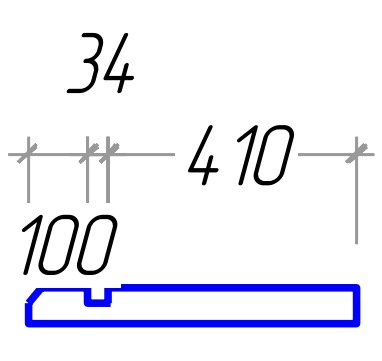
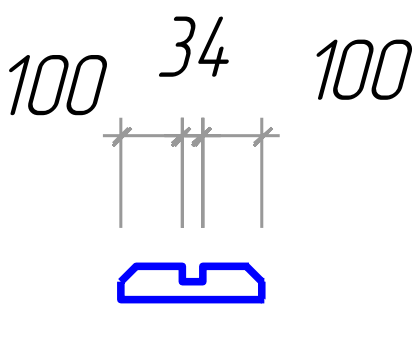
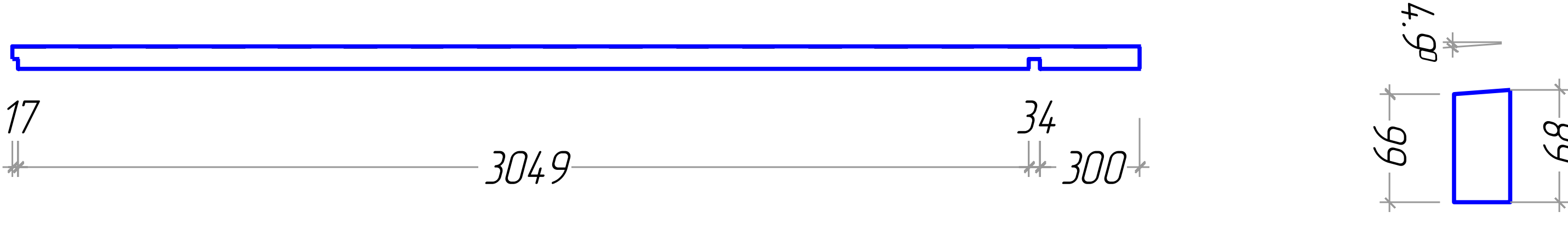
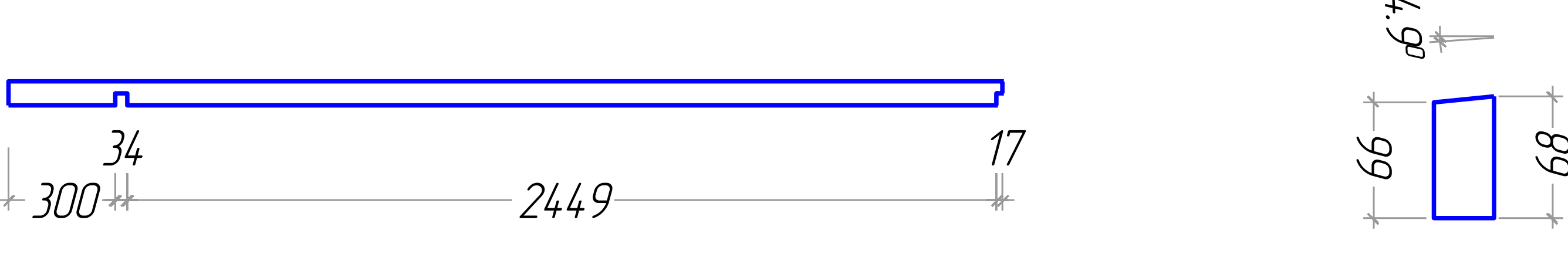
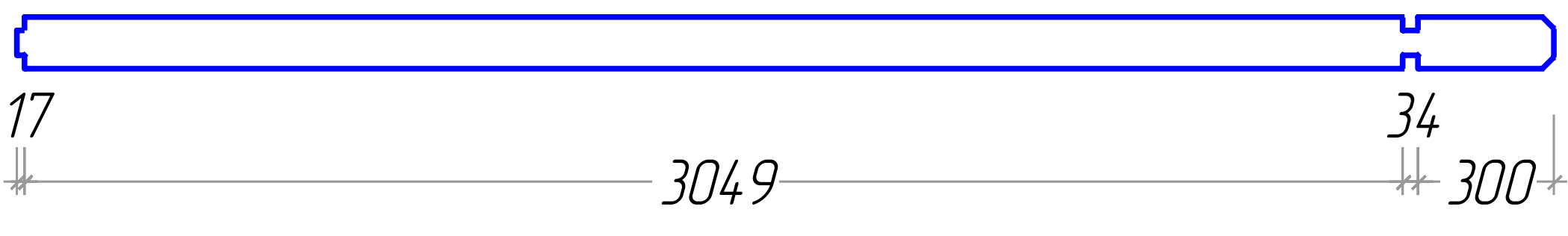
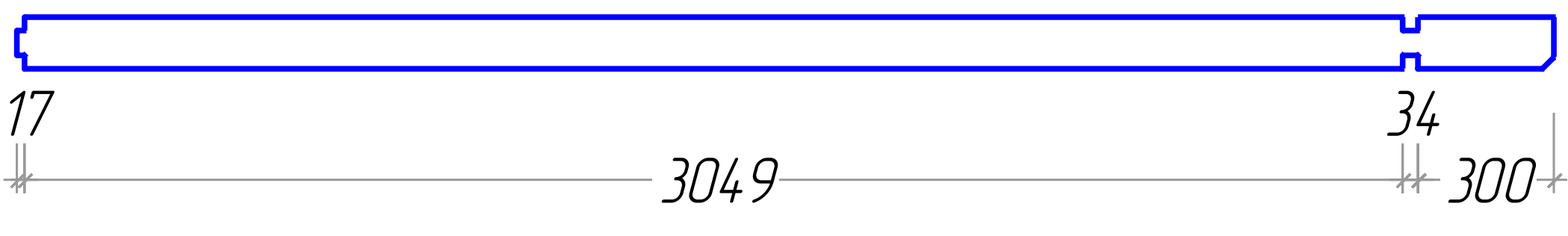
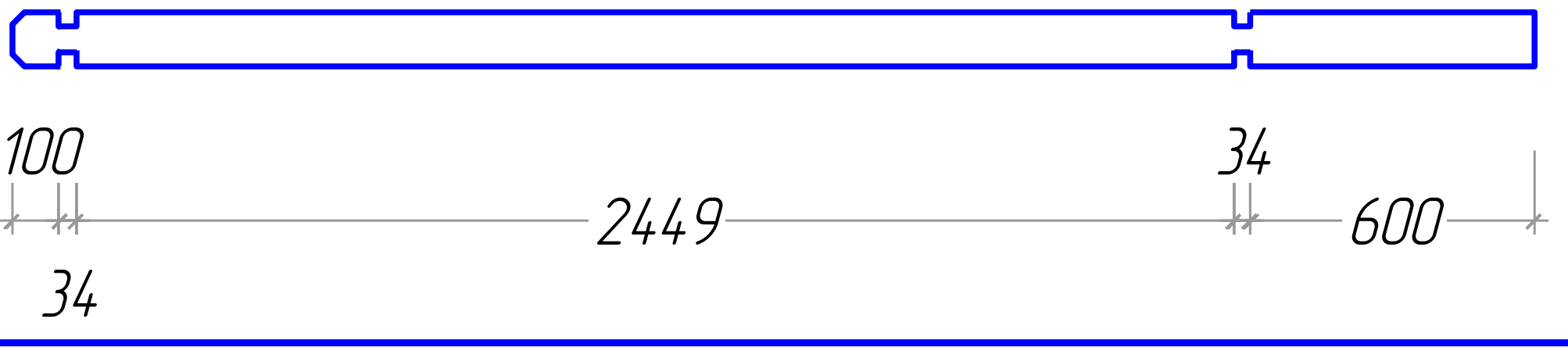
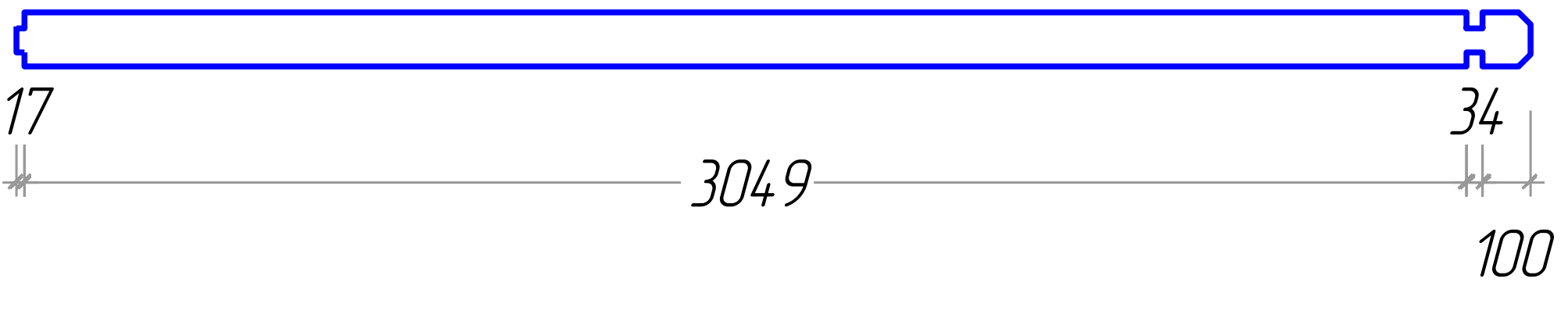
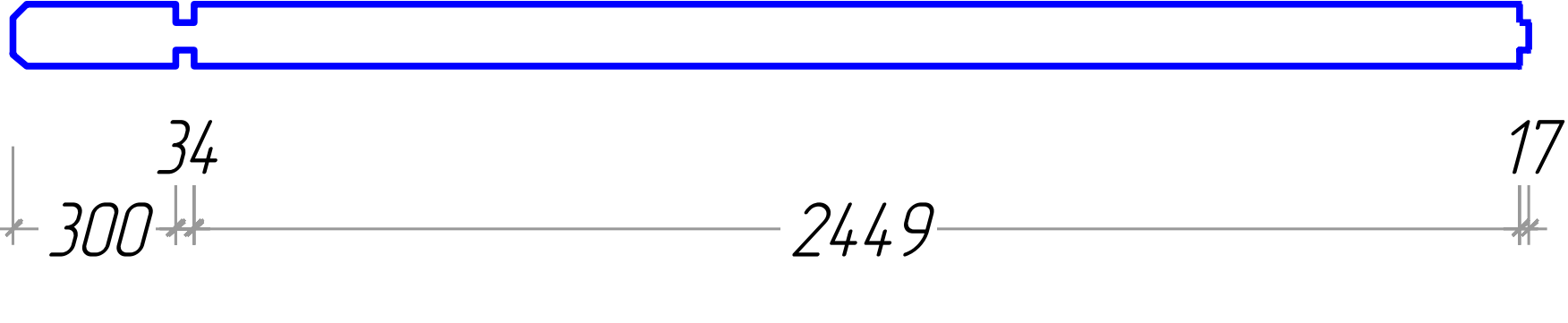
Nº	Elvis 34 5,6x2,5	Nr.	Profile (mm)	Length (mm)
1		1	34x50,6	3400mm
2		1	34x50,6	2800mm
3		1	34x57	3200mm
4		1	34x57	2600mm
5		2	34x57	544mm
6		1	34x57	234mm
7		1	34x68,4	3400mm
8		1	34x68,4	2800mm
9		1	34x114	3400mm
10		2	34x114	3400mm
11		14	34x114	3217mm
12		4+1	34x114	3200mm
13		1	34x114	2800mm

Nº	<i>Elvis 34 5,6x2,5</i>	Nr.	Profile (mm)	Lenght (mm)
14		2	34x114	2800mm
15		2	34x114	2717mm
16		57	34x114	2700mm
17		3	34x114	2700mm
18		4+1	34x114	2600mm
21		14	34x114	734mm
22		14	34x114	599mm
23		34	34x114	544mm
24		19	34x114	234mm
25	<i>Foundation Fundament Solive</i> 	6	44x68	3007mm
26	<i>Foundation Fundament Solive</i> 	4	44x68	2490mm
27	<i>Foundation Fundament Solive</i> 	6	44x68	2407mm
28	<i>Roof beam. Dachbalken. Panne</i> 	1	44x140	3400mm

Nº	<i>Elvis 34 5,6x2,5</i>	Nr.	Profile (mm)	Lenght (mm)
29	<p>Roof beam. Dachbalken. Panne</p>	1	44x140	2800mm
30	<p>Roofing felt fillet Giebelabschlussbrett Latte de finition couverture</p>	2	20x58	3100mm
31	<p>Roofing felt fillet Giebelabschlussbrett Latte de finition couverture</p>	2	20x58	2956mm
32	<p>Roof boards. Dachbretter Volige</p>	54+1	20x115	3014mm
33	<p>Floor boards Fu ssboden Lame de plancher</p>	25+1	20x115	2459mm
34	<p>Floor boards Fu ssboden Lame de plancher</p>	24	20x115	2428mm
35	<p>Fascia board Giebelblende Planch de rive facade</p>	2	20x120	3118mm
36	<p>Roof side boards Traufenbrett Planche de rive</p>	2	20x120	3098mm
37	<p>Roof side boards Traufenbrett Planche de rive</p>	2	20x120	3014mm
38	<p>Floor edge trim Fu bleisten Plinthe plancher</p>	1	18x20	3049mm
39	<p>Floor edge trim Fu bleisten Plinthe plancher</p>	1	18x20	2449mm
40	<p>Floor edge trim Fu bleisten Plinthe plancher</p>	4	18x20	2432mm
41	<p>Floor edge trim Fu bleisten Plinthe plancher</p>	2	18x20	367mm

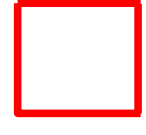
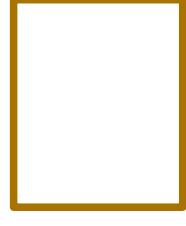
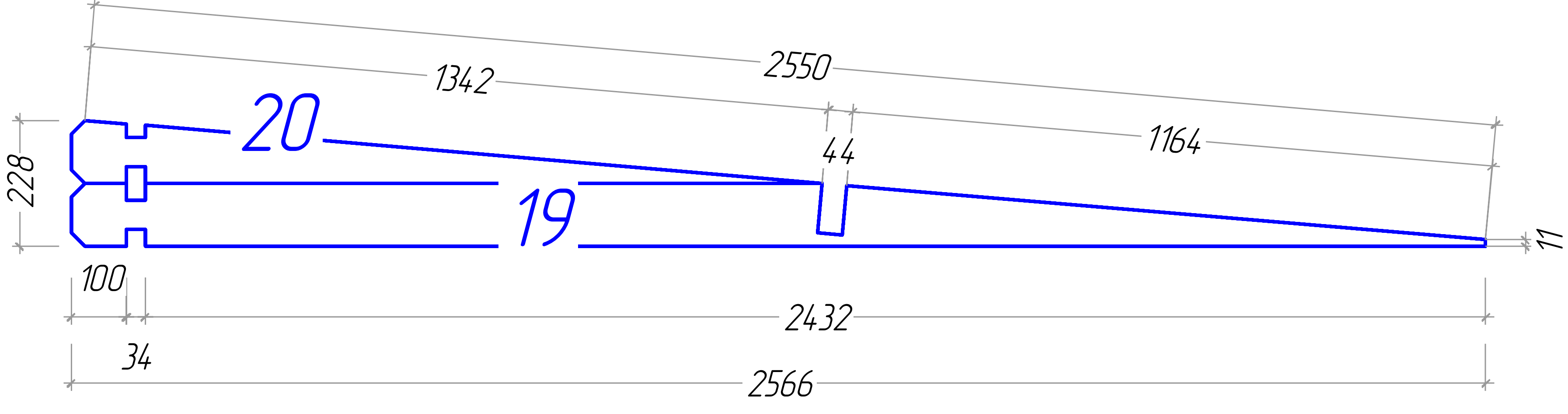
N°	Elvis 34 5,6x2,5	Nr.	Profile (mm)	Lenght (mm)
42	Floor edge trim Fu bleisten Plinthe plancher 	2	18x20	100mm
43	Roof edge reinforcement Traufenteisteu Tasseau 	4	28x34	3100mm
W 1		3		
	Door Tur La porte 1995x1630mm	1		
	Window Fenetre Fenster 1596x625mm	2		