

*BRIGHTON 70*  
*Art.No. 7011802*

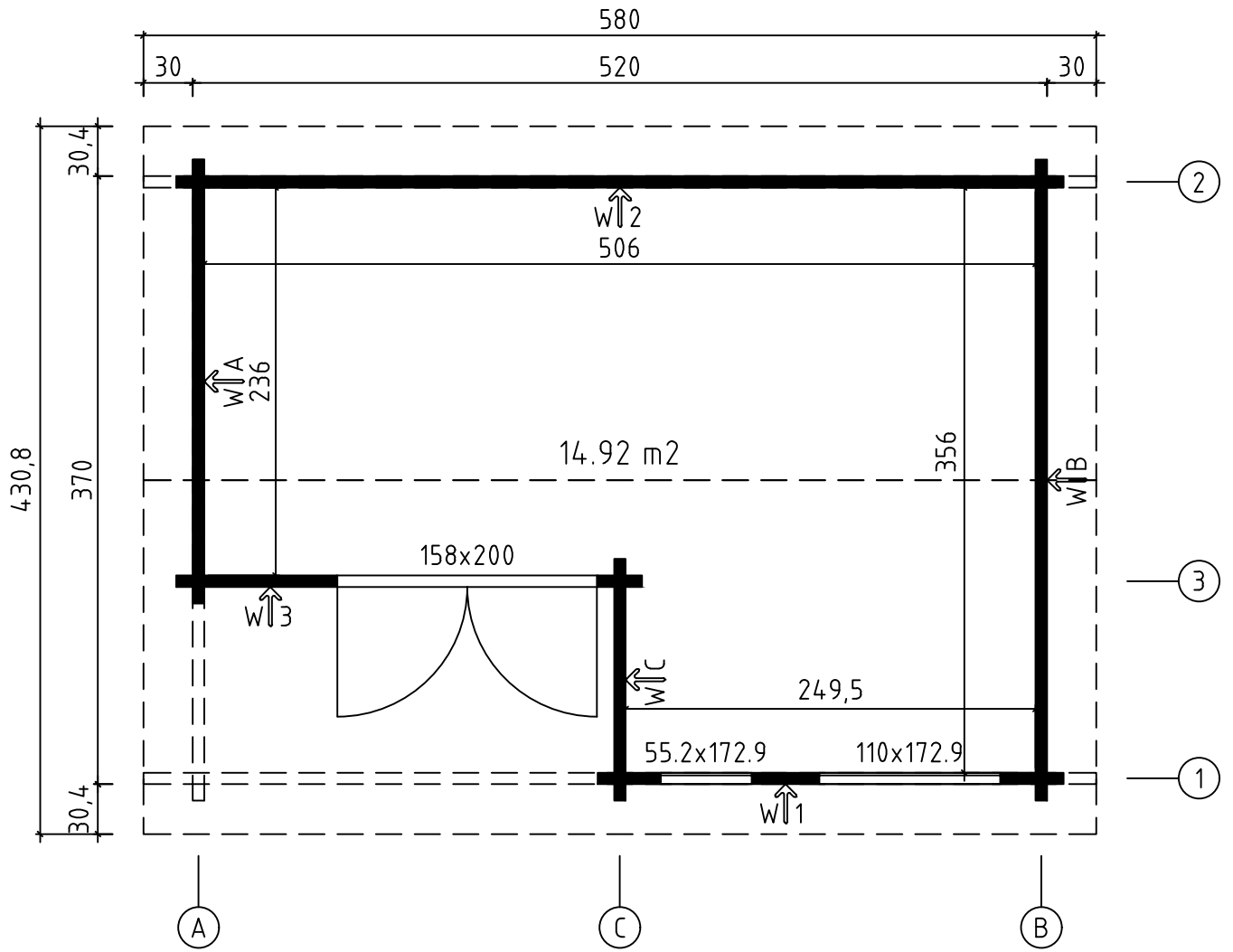

Groundplan - Grundplan - Plan de masse - Planimetria - Plattegrond - Põhiplaan



Foundation - Fundament - Fondation - Fondamenta - Fundering - Immutatud alusraam

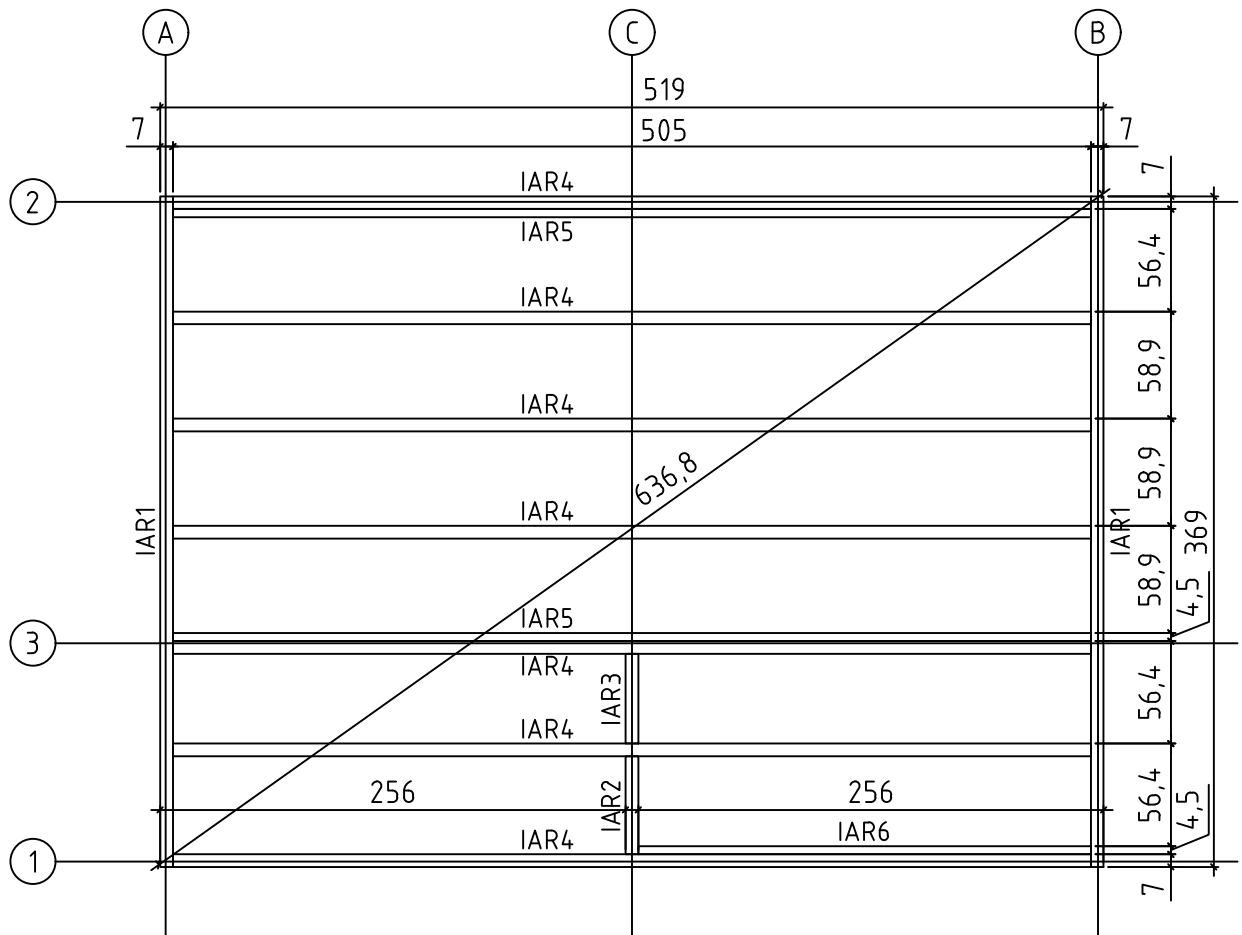

Floor boards - Fussbodenbretter - Plan pose plancher - Pavimento - Vloerhout - Põrandalaudis

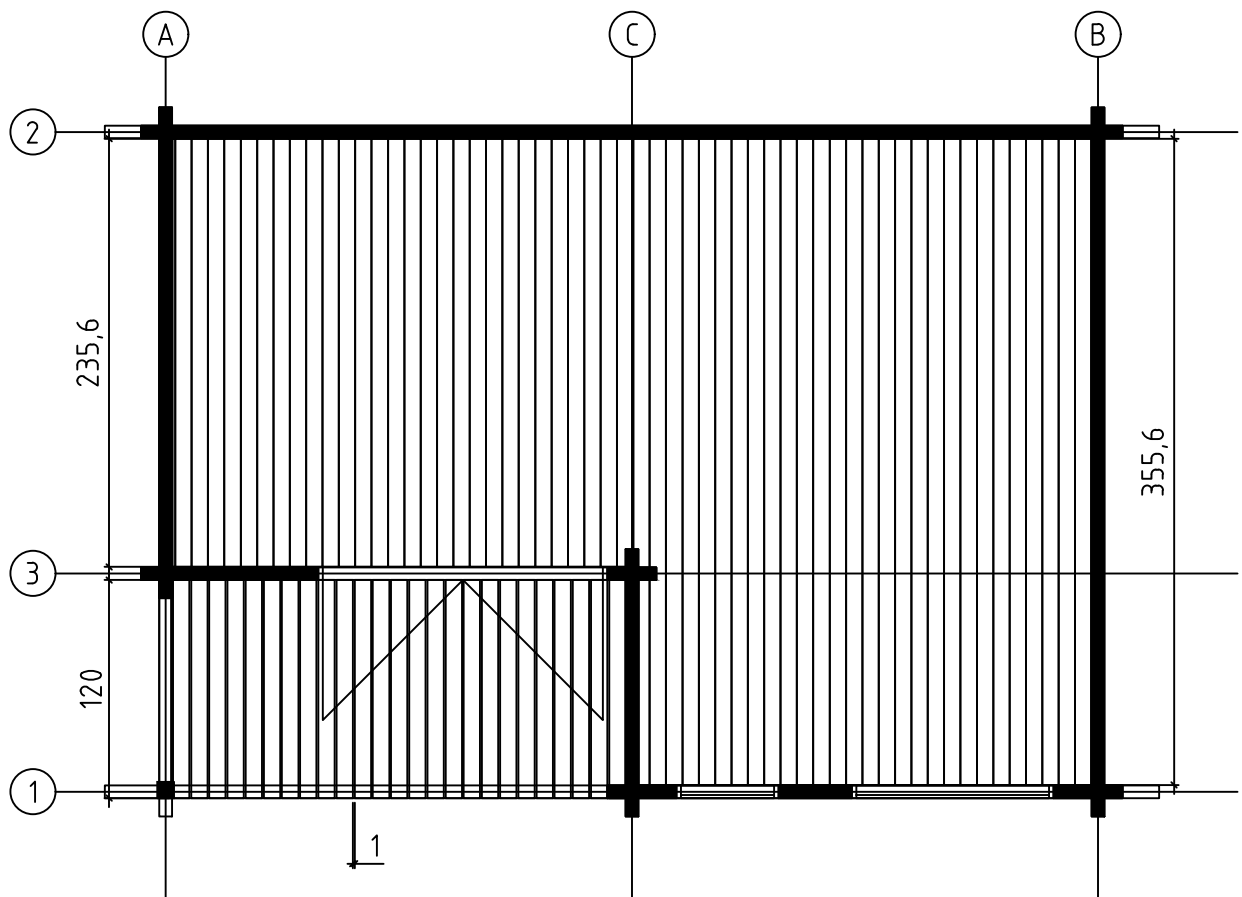

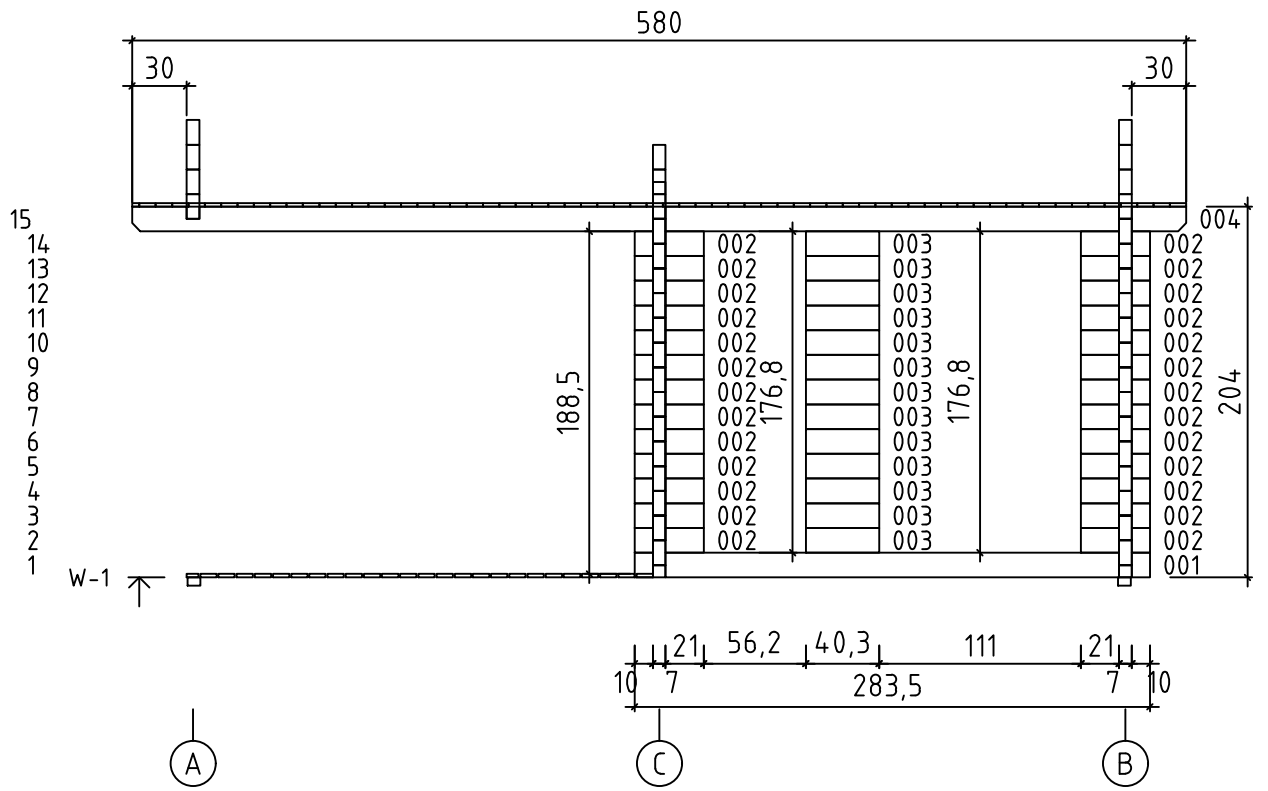

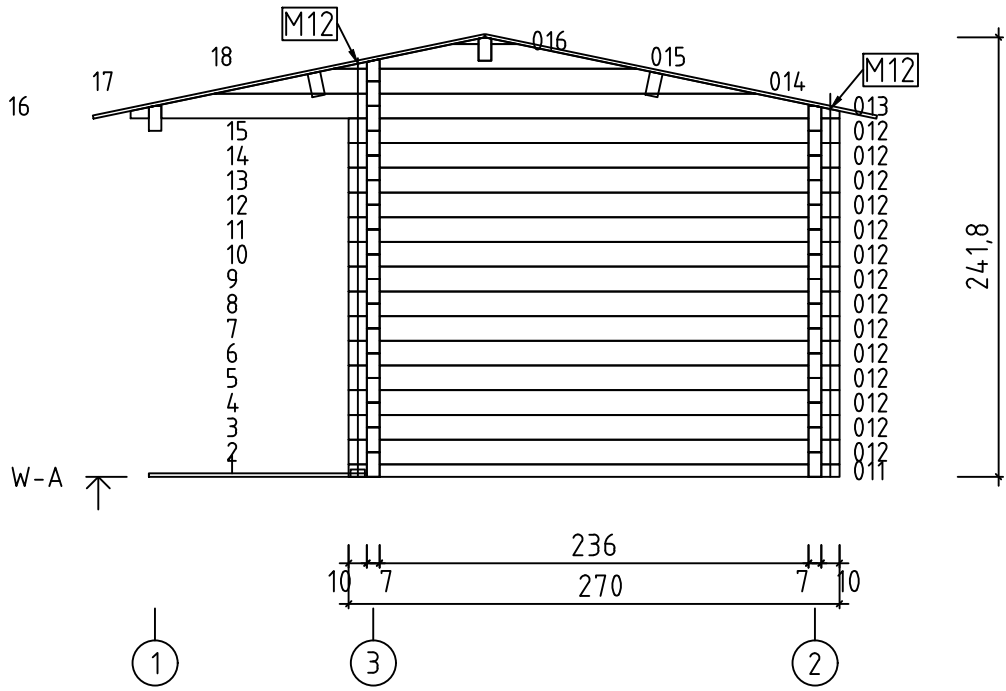
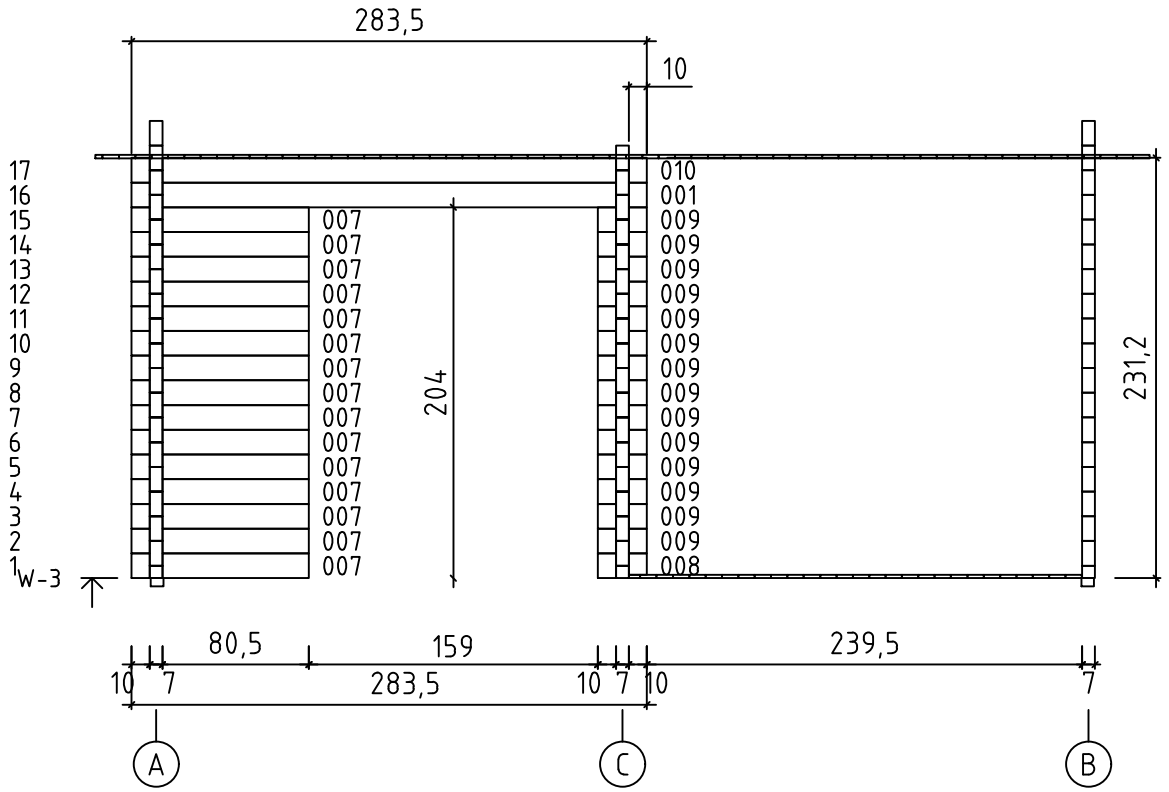

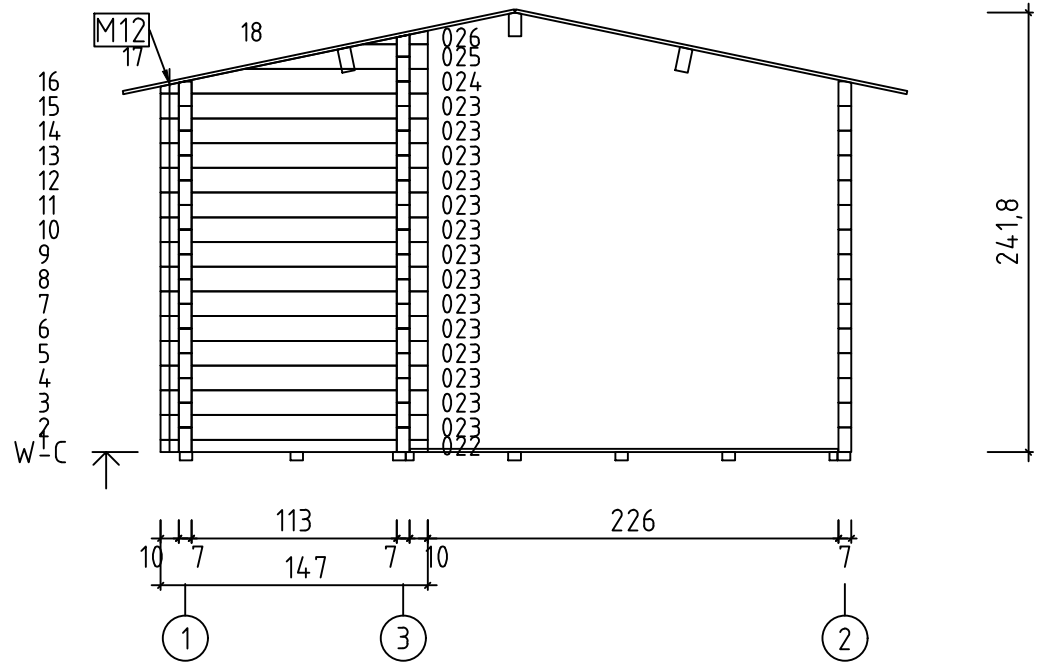
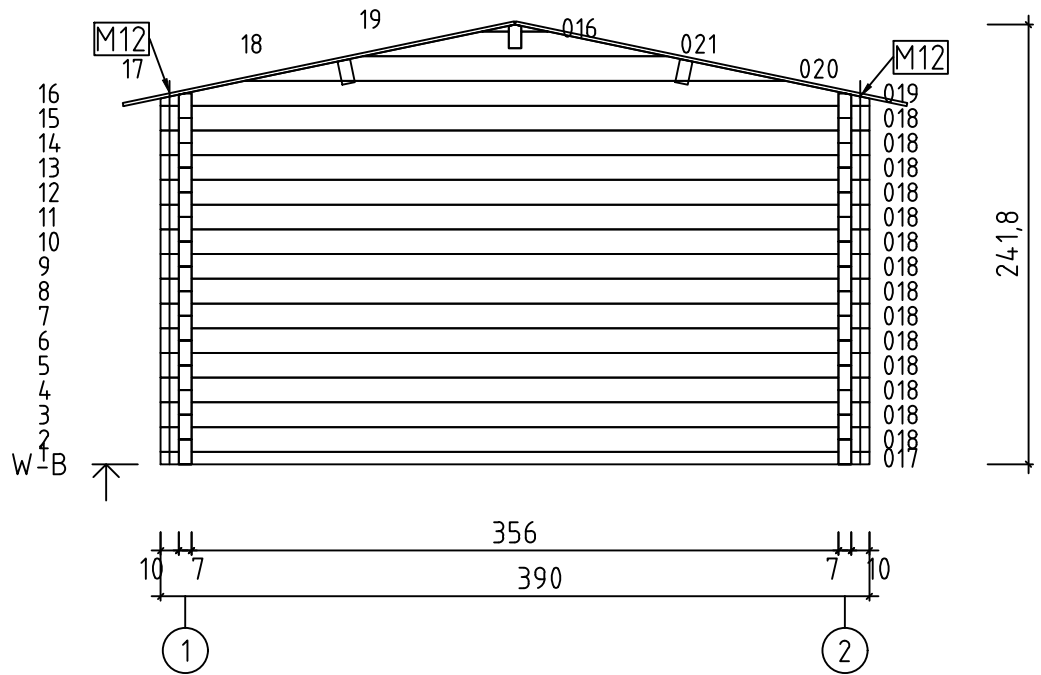

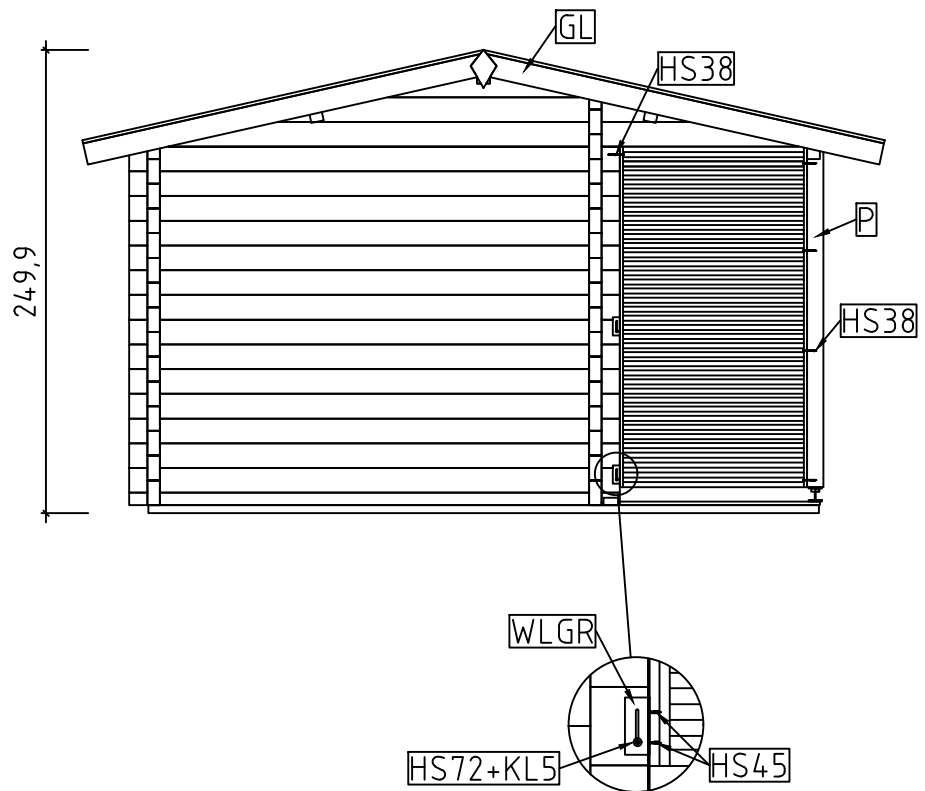
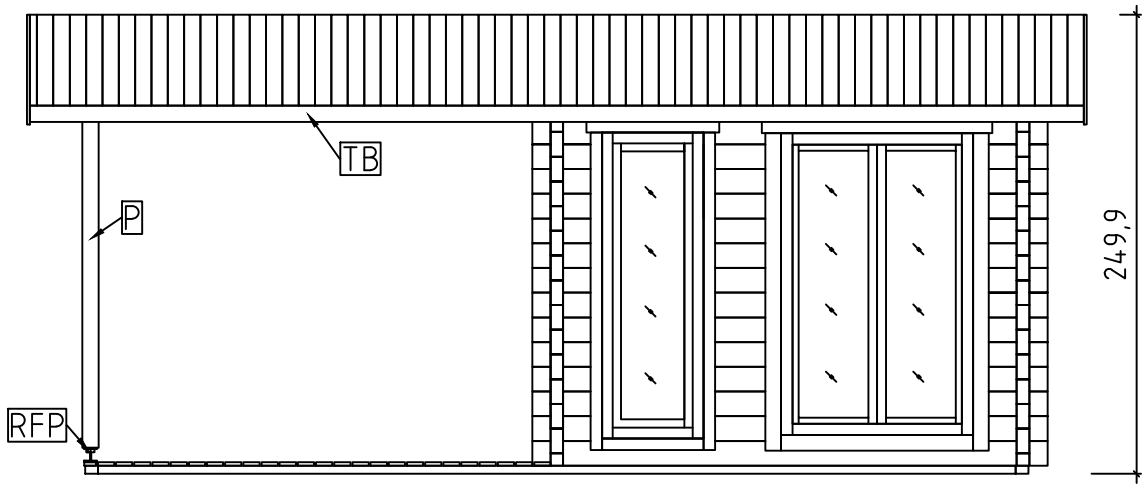

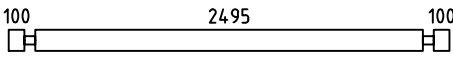

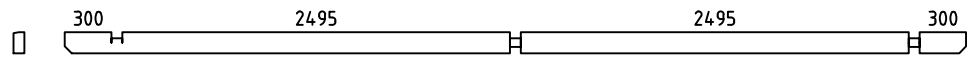
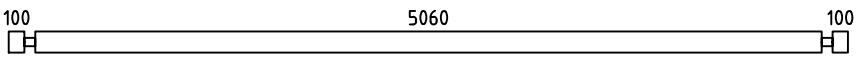
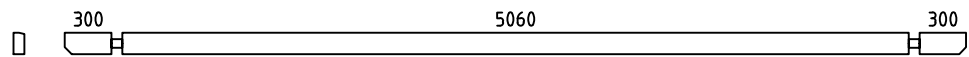
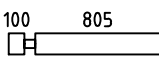

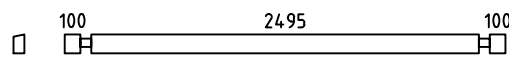
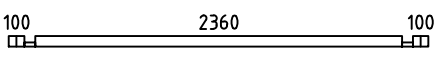
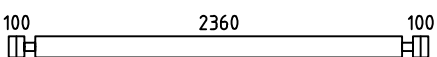
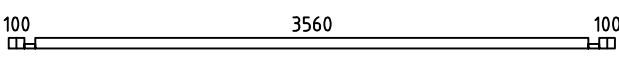
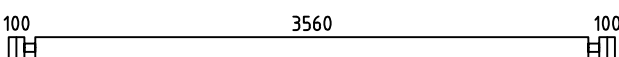
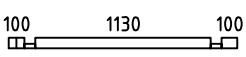
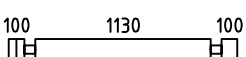
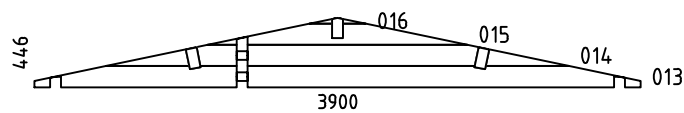
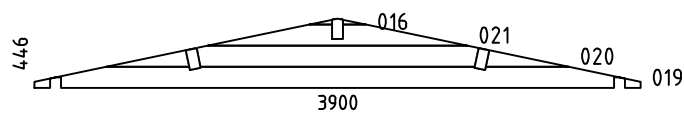
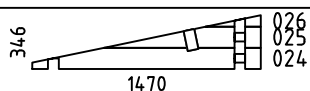
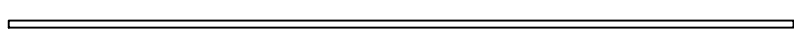
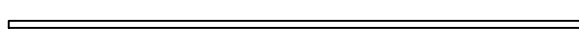



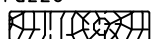

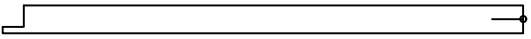



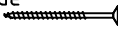

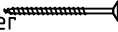

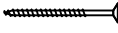
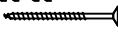
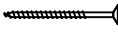
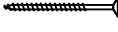
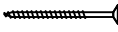
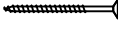
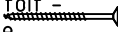
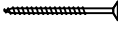
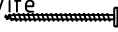
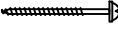

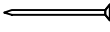
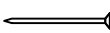
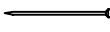
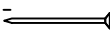
Pos	BRIGHTON 70, Art.No.7011802 Piece list - Stückliste - Liste des pièces - Elementi - Stuklijst - Tükítabel	Q	P (mm)	L (mm)
001		2	70x136	2835
002		26	70x136	380
003		13	70x136	403
004		1	70x136	5800
005		14	70x136	5400
006		1	70x136	5800
007		15	70x136	975
008		1	70x136	270
009		14	70x136	270
010		1	70x121	2835
011		1	70x68	2700
012		14	70x136	2700
017		1	70x68	3900
018		14	70x136	3900
022		1	70x68	1470
023		14	70x136	1470
WA-1		1		
WB-1		1		
WC-1		1		
IAR4	Foundation - Fundament - Fondation - Fondamenta - Fundering - Immutatud alusraam 	7	70x45	5050
IAR1	Foundation - Fundament - Fondation - Fondamenta - Fundering - Immutatud alusraam 	2	70x45	3690



Pos	BRIGHTON 70, Art.No.7011802 Piece list - Stückliste - Liste des pièces - Elementi - Stuklijst - Tükítabel	Q	P (mm)	L (mm)
IAR2	Foundation - Fundament - Fondation - Fondamenta - Fundering - Immutatud alusraam 	1	70x45	539
IAR3	Foundation - Fundament - Fondation - Fondamenta - Fundering - Immutatud alusraam 	1	70x45	494
IAR5	Foundation - Fundament - Fondation - Fondamenta - Fundering - Immutatud alusraam 	2	45x45	5050
IAR6	Foundation - Fundament - Fondation - Fondamenta - Fundering - Immutatud alusraam 	1	45x45	2490
PR1	Roof beam - Dachbalken - Panne de toit - Perlina del tetto - Gordingen / dakbalk - Põhipärilin 300 5060 300 	1	70x170	5800
A-PR1	Roof beam - Dachbalken - Panne de toit - Perlina del tetto - Gordingen / dakbalk - Pärilin 300 5060 300 	1	70x170	5800
A-PR2	Roof beam - Dachbalken - Panne de toit - Perlina del tetto - Gordingen / dakbalk - Pärilin 300 2495 2495 300 	1	70x170	5800
FB-1	Floor boards - Fussbodenbretter - Lame de plancher - Pavimento - Vloerhout - Põrandalaud 	28	90x18	3556
FB-2	Floor boards - Fussbodenbretter - Lame de plancher - Pavimento - Vloerhout - Põrandalaud 	29	90x18	2356
RB-1	Roof boards - Dachbretter - Voliges - Perlina per tetto - Dakhout - Katuselaud 	130	90x18	2200
SV	Terrace boards - Terrassenbretter - Plancher de terrasse - Piattaforme terrazzo - Terrasvloer - Terrassilaud 	26	90x19	1200
FL-1	Floor fillet - Fussbodenleiste - Corniere de finition du plancher - Finitura per pavimento (battisco pa) - Vloerafwerklijst - Põrandaliist 		18x18	17.23
DPL	Roofing felt fillet - Dachpappenleiste - Baguette de fixation du feutre bitumeux - Asse per fissaggio guaina bituminosa - Afdekljst asfaltpapier - Katusepapiiliist 	4	18x58	2250
M12	Treaded rod m12 - Gewindestange m12 - Tige filetée m12 - Barra filettata passo m12 - Draadstang 12m - Keermelatt 	4		50
M12	Treaded rod m12 - Gewindestange m12 - Tige filetée m12 - Barra filettata passo m12 - Draadstang 12m - Keermelatt 	1		280
M12	Treaded rod m12 - Gewindestange m12 - Tige filetée m12 - Barra filettata passo m12 - Draadstang 12m - Keermelatt 	5		2000
P	Post - Pfosten - Poteau - Piede registrabile - Stijl - Post 	1	90x90	1870
TB	Fascia board - Traufbrett - Bandeau de toit - Finitura lati tetto - Gevellijst - Räästalaud 	4	18x90	2900
DRV	Roof edge reinforcement - Dachrandverstärkung - Corniere de renfort de bord de toit - Rinforzo x tetto - Dakrand versterking - Räästatugevdus 	4	28x34	2900
GL	Gable moulding - Giebelleiste - Planche de rive - Finitura per frontale e retro del tetto - Gevellijst - Viilulaud 	4	18x120	2250
KL4	Lengthening bolt for treaded rod - Verlängerungsmutter für gewindestange - Manchon de raccordement de tige filetée - Bullone per barra filettata passo - Extensie moer voor draadstang - Jätikumutter keermelatile 	5		
KL1	Drive nut treaded rod - Ein Schlagmutter für gewindestange - Écrou a frapper pour tige filetée - Dado guida per barra filettata - Aandrijfmoer / aanslagmoer voor draadstang - Löökmutter keermelatile 	5		
KL2	Nut for treaded rod - Mutter für gewindestange - Écrou pour tige filetée - Dado per barra filettata - Moer voor draadstang - Mutter keermelatile 	5		

Pos	BRIGHTON 70, Art.No.7011802 Piece list - Stückliste - Liste des pièces - Elementi - Stuklijst - Tükítabel	Q	P (mm)	L (mm)
KL3	Plain washer treaded rod - Unterlegscheibe für gewindestange - Rondelle plate pour tige filetée - Rondella per barra filettata - Sluifring voor draadeind - Seib keermelafite 	5		
HS12	Screw for gable segment - Schrauben für deckblatt - Vis pour fixation losange de finition - Viti x frontali tetto - Schroef voor gevelpunt segment - Kruvi rombile 	4	3.5x35	
HS16	Screw for gable moulding - Schrauben für giebelleiste - Vis pour fixation planche de rive - Vite per fissare finiture davanti e dietro del tetto - Schroef voor gevellijst - Kruvi viilulauale 	24	3.5x50	
HS38	Screws for fixing terrace posts to panels/railings - Schrauben für terrassenelement / zu pfosten - Vis d'assemblage des montants de l'avancée de la toiture au garde-corps - Viti per fissaggio ringhiere posteriori del terrazzo - Schroeven ter bevestiging terrashek-paal - Kruvipiirdeia kinnitamiseks postiga 	5	4.5x80	
HS37	Screw for post - Schrauben für pfosten - Vis de fixation des poteaux - Viti per inviare - Schroef voor stijlen - Kruvi postile 	2	4.5x80	
HS45	Screw for sliding wall tie - Schieberegler für wand - Sabot métallique pour fixation mur - Vite per fissare scorrimento a c su slitta fissata alla parete - Schuifdeur instellingen wand - Kruvi seinaliugurite 	8	4x20	
HS32	Screw for fascia boards - Schrauben für traufbretter - Vis pour fixation bandeau de toit - Viti x striscia del tetto - Schroef voor gevellijst - Kruvi räästlauale 	28	4x40	
HS26	Screw for roof edge reinforcement - Schrauben für dachrandverstärkung - Vis pour fixation corniere renfort de bord de toit - Viti x rinforzo bordo tetto - Schroef voor dakrand versterking - Kruvi räästatugevdusele 	28	4x40	
HS40	Screw for 1. wall beam - Schraube für 1. bohlenreihe - Vis de fixations 1ere rangée de madriers avec poutrelles de fondations - Vite fissaggio alle fondamenta - Schroef voor 1 wandbalk - Kruvi poollauale 	10	5x120	
HS39	Screw for foundation - Schrauben zur befestigung fundament - Vis de fixations des poutrelles de fondations - Viti x fondamenta - Schroef voor fundering - Kruvi alusraamile 	34	5x120	
HS42	Screw for gable - Schrauben für giebel - Vis pour fixation des pignons - Viti per timpano - Schroef voor gevelpunt - Kruvi viilude kinnitamiseks 	15	5x120	
HS43	Screw for roof beams - Schrauben für dachbalken - Vis pour fixation pannes de toit - Viti per perline del tetto - Schroef voor gordingen / dakbalken - Kruvi pärlinitele 	7	5x120	
HS49	Screw for post height adjustment - Schrauben für regulierungsschraube für pfosten - Vis de fixation de support réglable de poteau - Viti per fissare ed aggiustare l'altezza del palo verticale - Schroef voor hoogte instelling stijlen - Kruvi vajumispoldile 	8	6x50	
MS	Screw for doorstep - Schrauben für swelle - Vis pour fixation barre de seuil - Vite per soglia della porta - Schroef voor deurdoorpel - Kruvi lävepakule 	3	4.5x65	
HS72	Screw for sliding wall tie - Schieberegler für wand - Sabot métallique pour fixation mur - Vite per fissare scorrimento a c su slitta fissata alla parete - Schuifdeur instellingen wand - Kruvi seinaliugurite 	2	5x60	
SH70	Hammer block - Schlagholz - Calle de frappe - Blocco di legno da usare come cuscinetto quando si usa il martello - Slagklos - Löögiklots 	1		
NFD	Zn nail for roofing felt fillet - Zn nägel für dachpappenleiste - Pointe pour baguette de fixation feutre bitumeux - Chiodi x carta bituminosa x tetto - Spijker(nagel) voor asfaltpapier afdekljst - Papiliistunael 	20	2x40	
NF3	Zn nail for terrace - Zn nägel für terrassenbretter - Pointe pour plancher de terrasse - Chiodo zincato per terrazza - Spijker(nagel) voor terrasvloer - Nael terrassilauale 	156	2.1x50	
NFF	Zn nail for floor fillet - Zn nägel für fussbodenleiste - Pointe pour corniere de finition du plancher - Chiodi x fissaggio pavimento - Spijker(nagel) voor vloer afdekljst - Nael põrandaliistule 	35	1.4x40	
NF2	Zn nail for roof - Zn nägel für dachbretter - Pointe pour fixation voliges de toit - Chiodi x perline tetto - Spijker(nagel) voor dakhout - Nael katuselauale 	406	2.1x50	
NH1	Zn nail for floor - Zn nägel für fussbodenbretter - Clous pour plancher - Chiodi x perline pavimento - Spijker(nagel) voor vloer - Nael põrandalauale 	353	2.1x50	
ORZ	Montage set for doors and windows - Montage-set für türen und fenster - Jeu de montage portes et fenetres - Set di assemblaggio per porte e finestre - Montage set voor deur en raam - Orthez akna ja ukse montaaživahendid	1		
GS	Gable segment - Deckblatt - Losange de finition - Decorazione in legno x frontale tetto - Gevelpunt segment - Romb 	2		

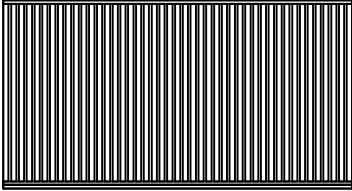
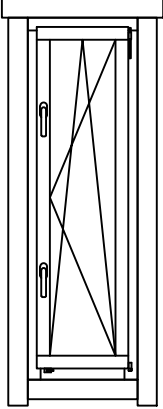
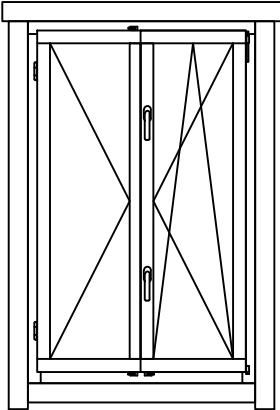
Pos	BRIGHTON 70, Art.No.7011802 Piece list - Stückliste - Liste des pièces - Elementi - Stuklijst - Tükítabel	Q	P (mm)	L (mm)
KL5	Plain washer - Unterlegscheibe - Rondelle plate - Rondella piana - Sluiring - Seib seina ja sarikaliugurite 6 mm 	2		
WLGR	Sliding wall tie - Schieberegler für wand - Sabot métallique pour fixation mur - Cravatta parete scorrevole - Schuifregelaar voor wand - Seinaliugur 	2		
RFP	Post height adjustment - Regulierungsschraube für pfosten - Support réglable de poteau - Piede registrabile in altezza - Stelschroef voor stijlpost - Vajumispolt 	1		
TRR2	Terrace railing - Terrassenzaun - Garde-corps de terrasse - Ringhiera per terrazza - Terras rails (leuning) - Päärdaed 	1	1028	1870
2+ A.0P.b	Window - Fenster - Fenetre - Finestra - Raam - Aken 552x1729 	1		
2+ TA.0P.b	Window - Fenster - Fenetre - Finestra - Raam - Aken 1100x1729 	1		



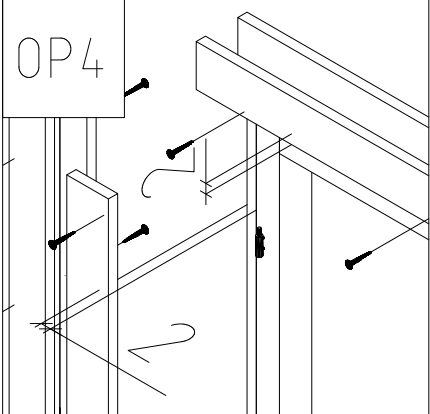
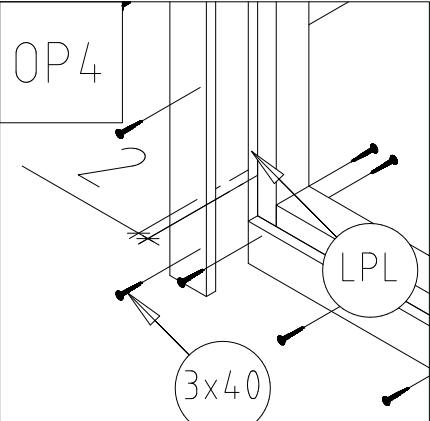
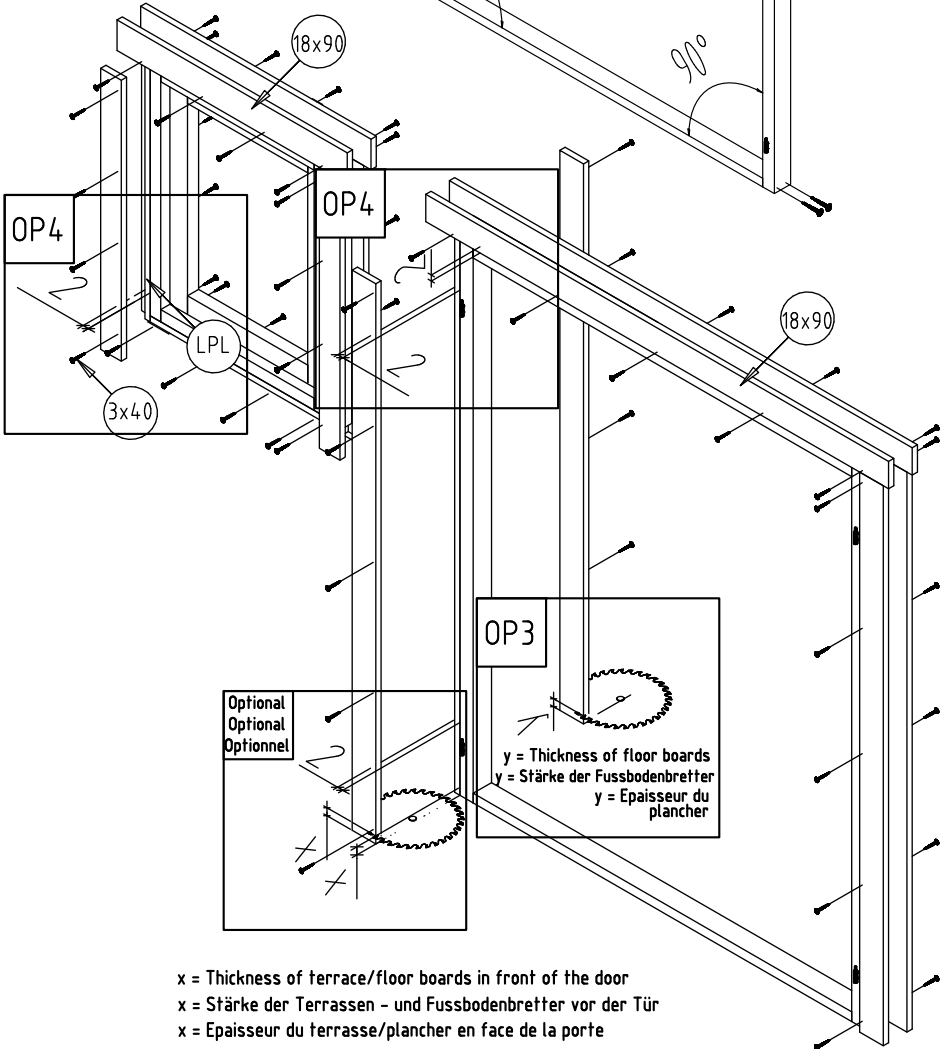
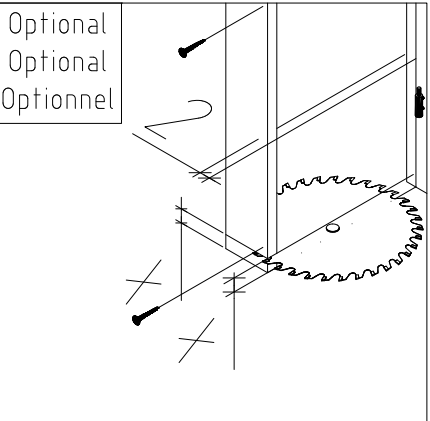
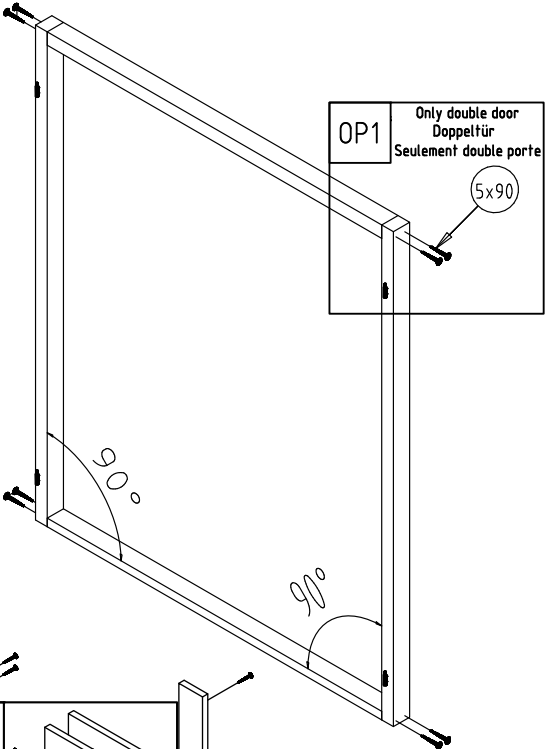
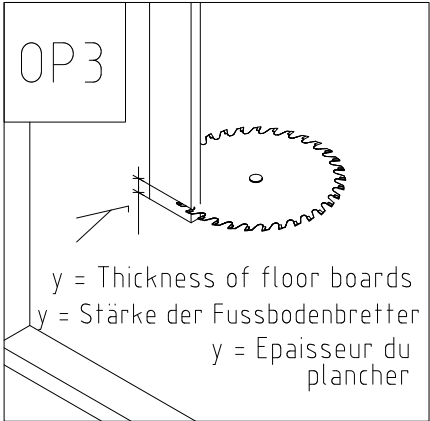
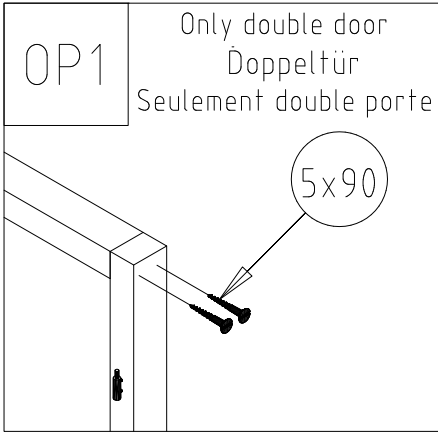

x = Thickness of terrace/floor boards in front of the door  
x = Stärke der Terrassen - und Fussbodenbretter vor der Tür  
x = Epaisseur du terrasse/plancher en face de la porte

