

Dingwall
Art.No. 7013402

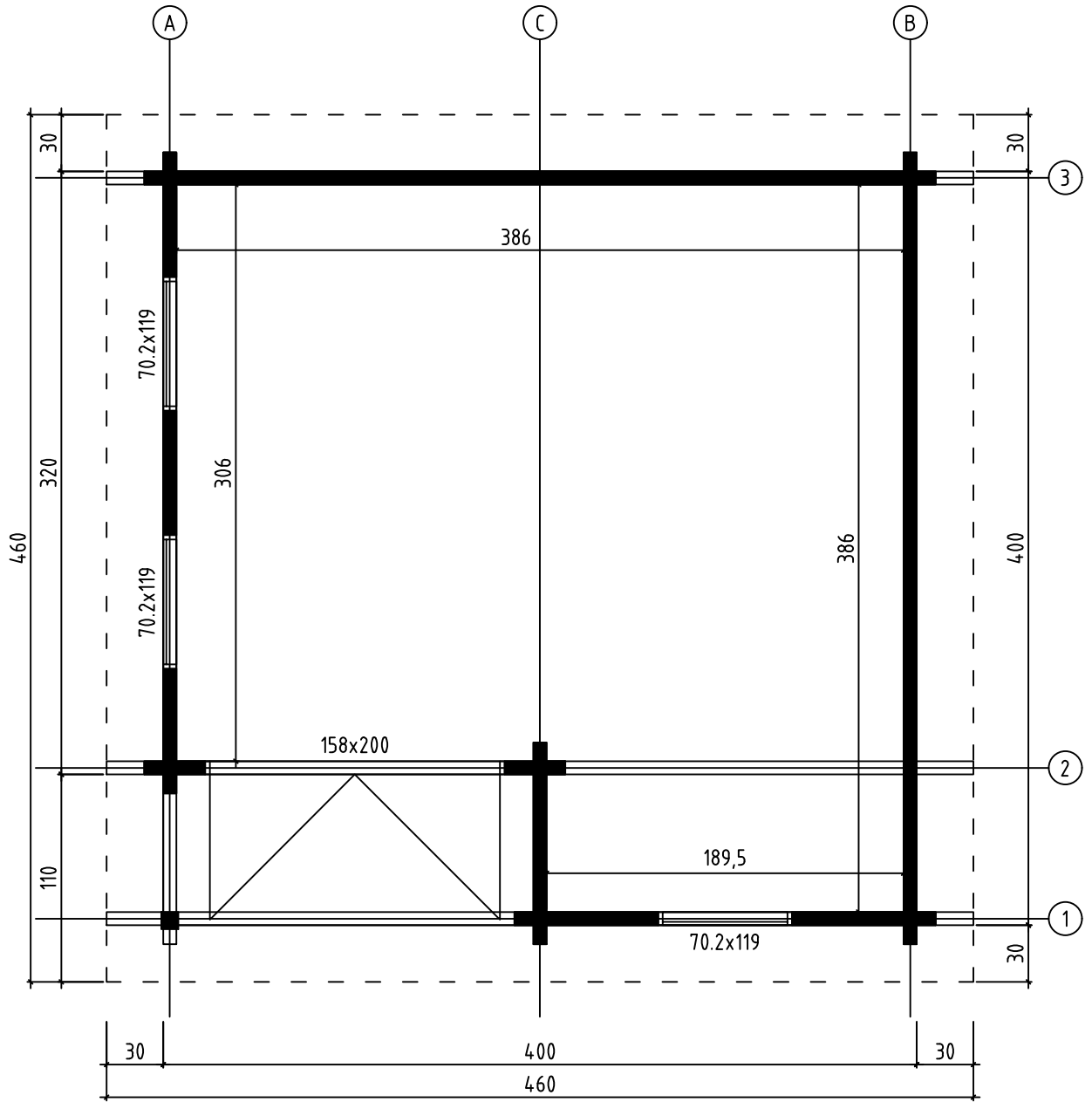

Dingwall, Art.No.7013402
GROUNDPLAN - GRUNDPLAN - PLAN DE MASSE



Dingwall, Art.No.7013402
 FOUNDATION - FUNDAMENT - FONDATION

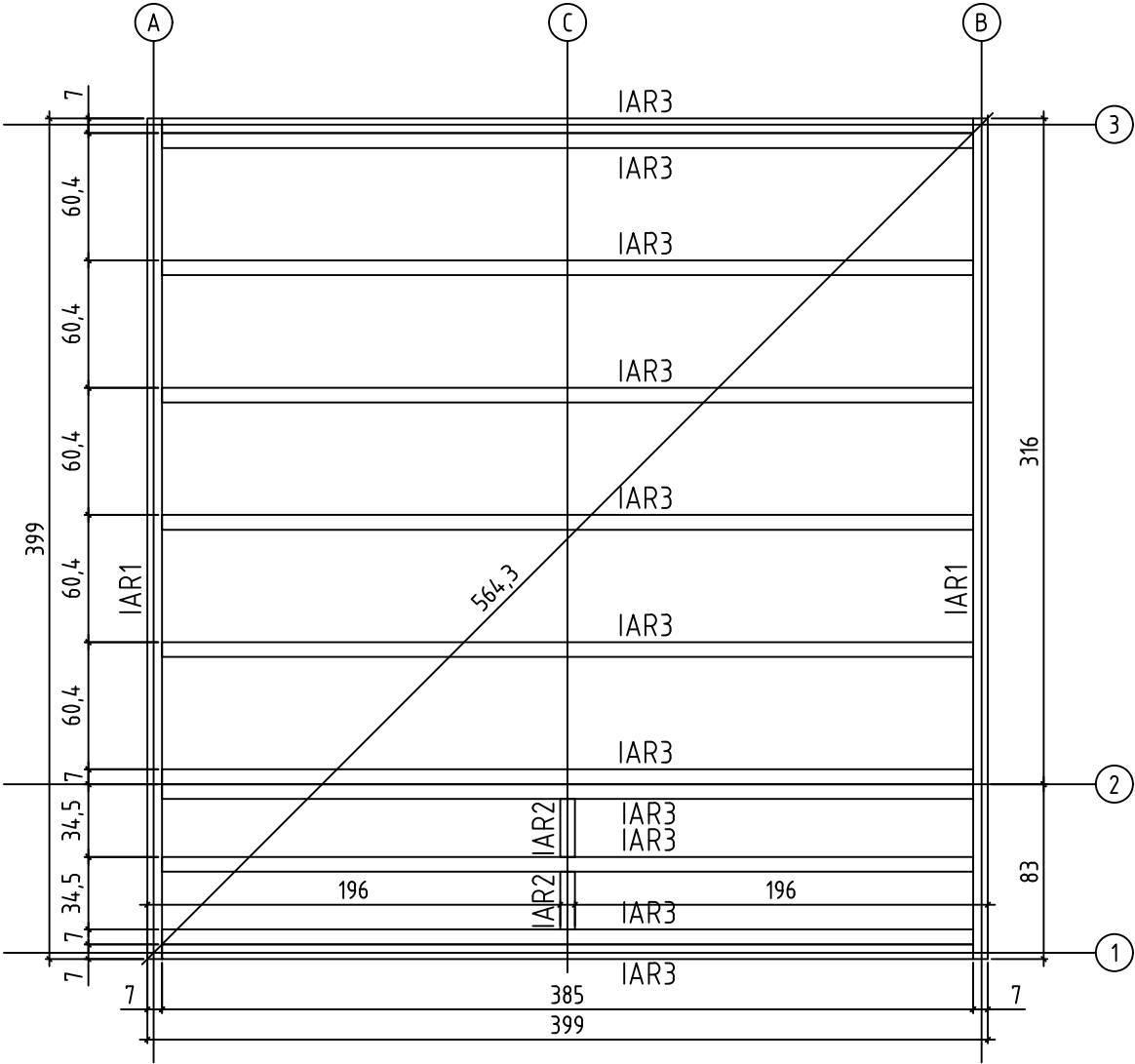

Dingwall, Art.No.7013402
FLOOR BOARDS - FUSSBODENBRETTER - PLAN POSE PLANCHER

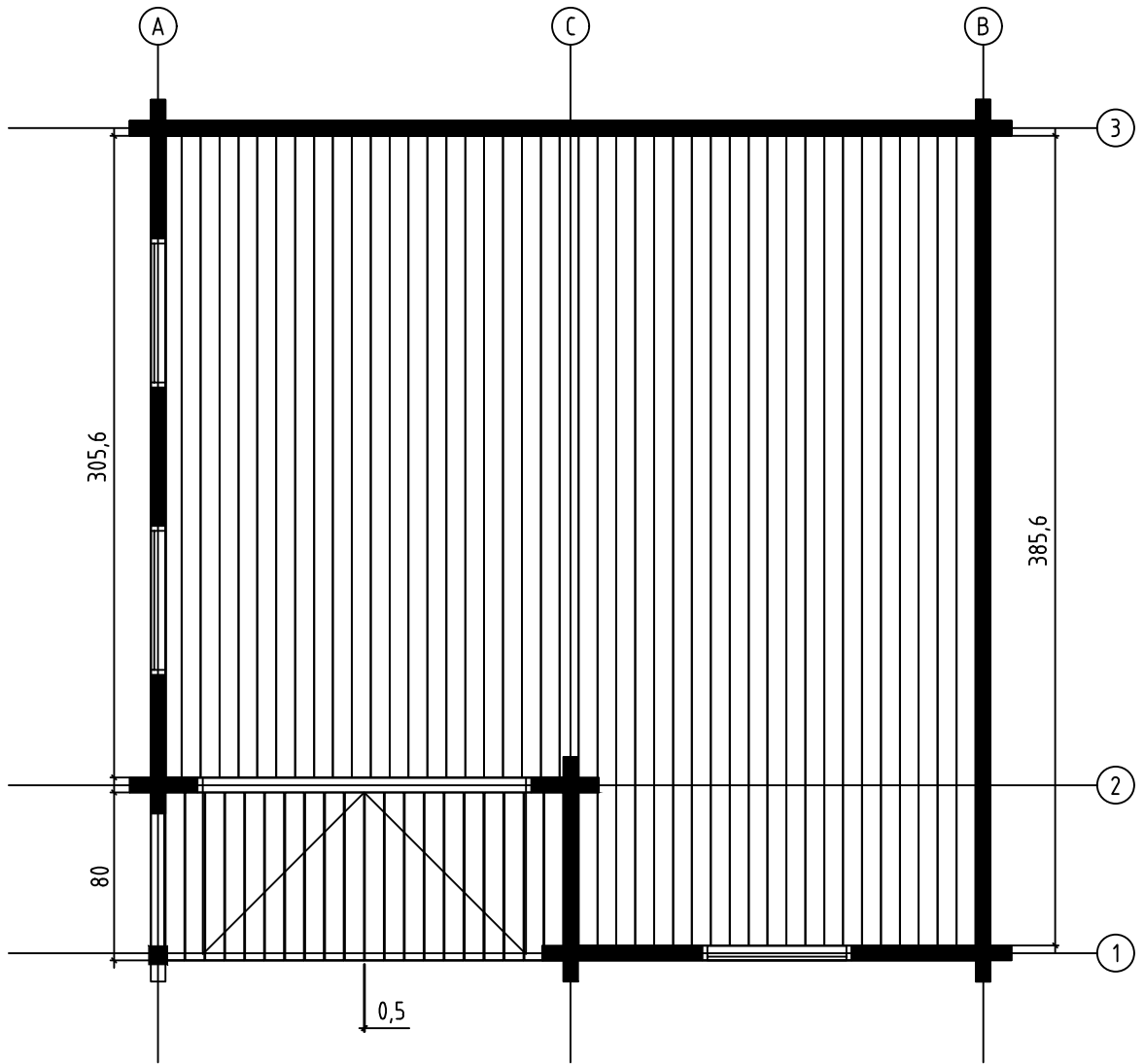

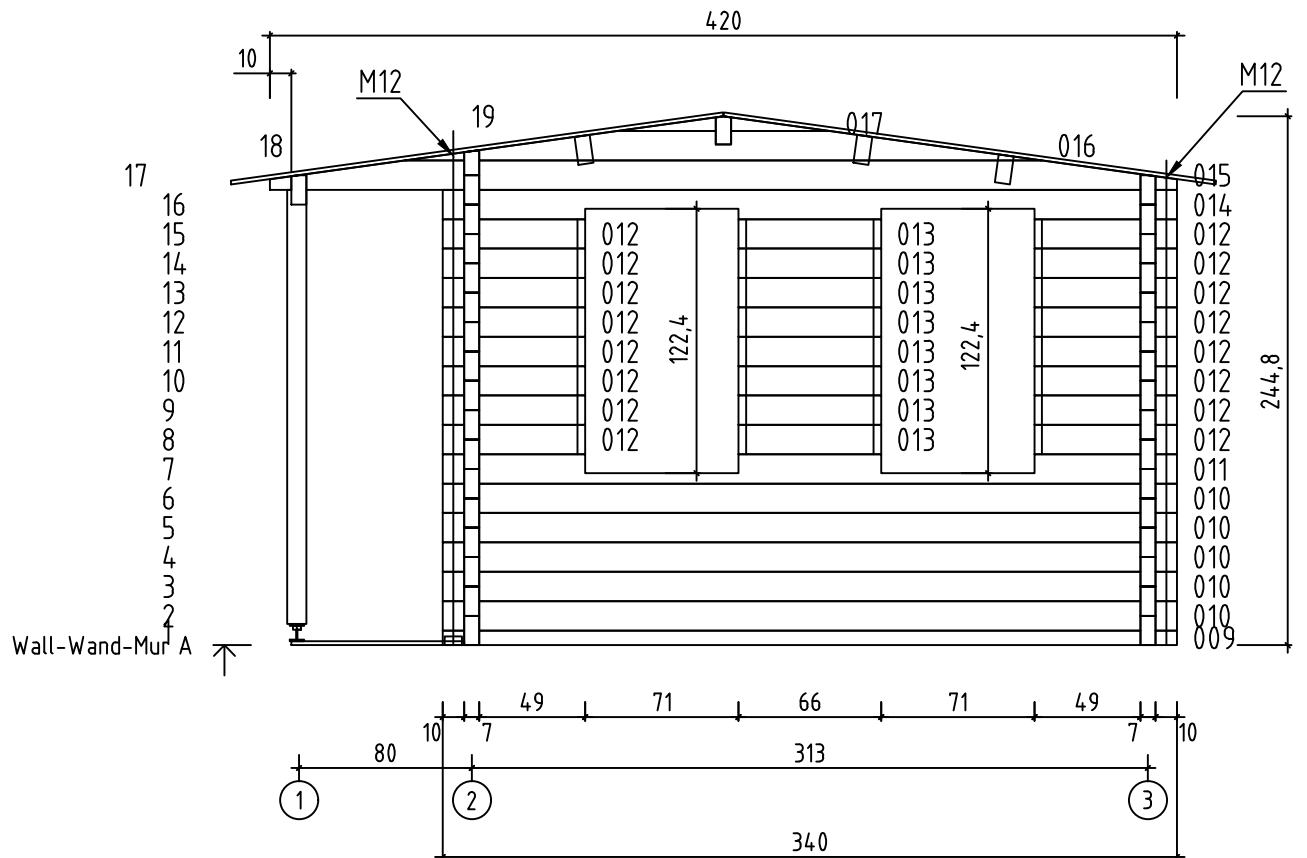
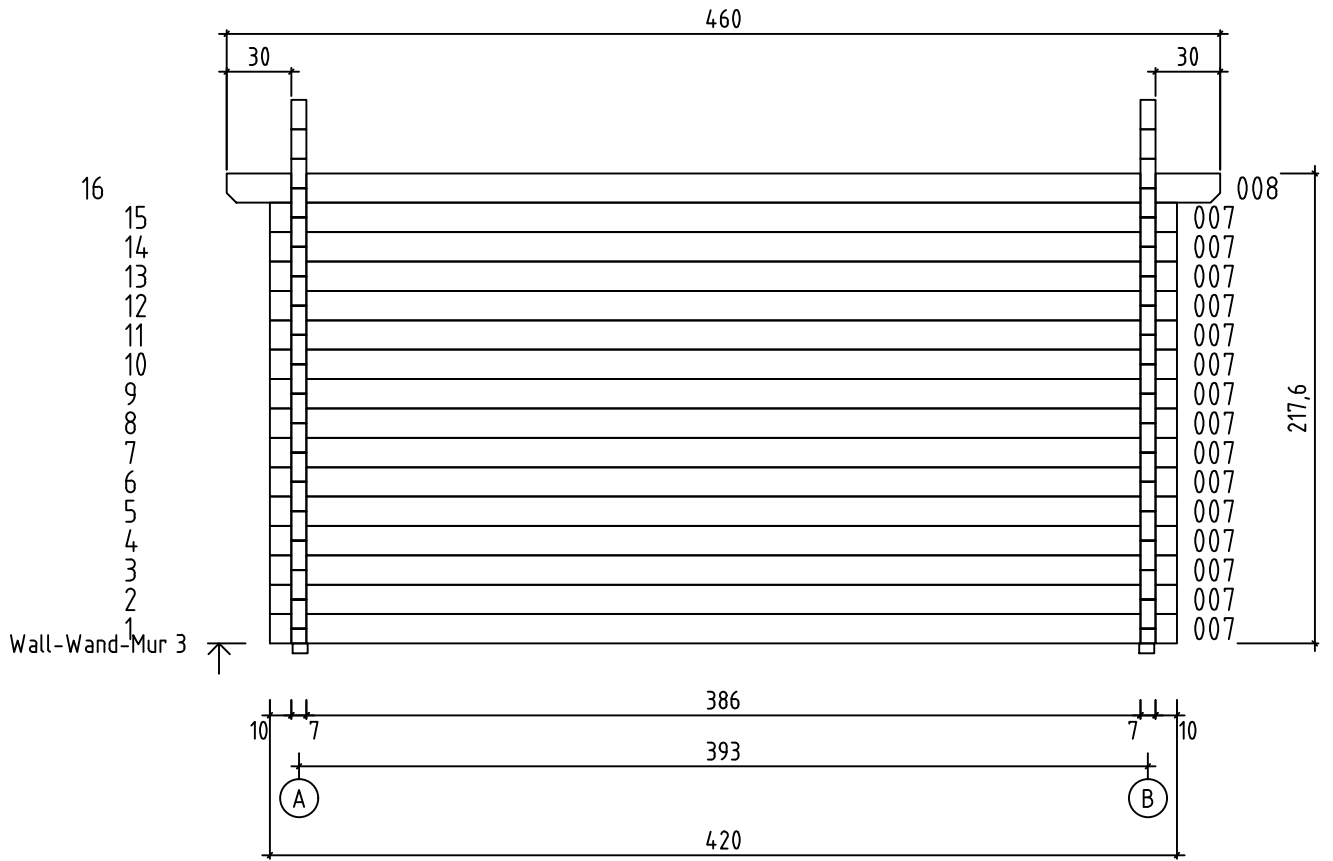



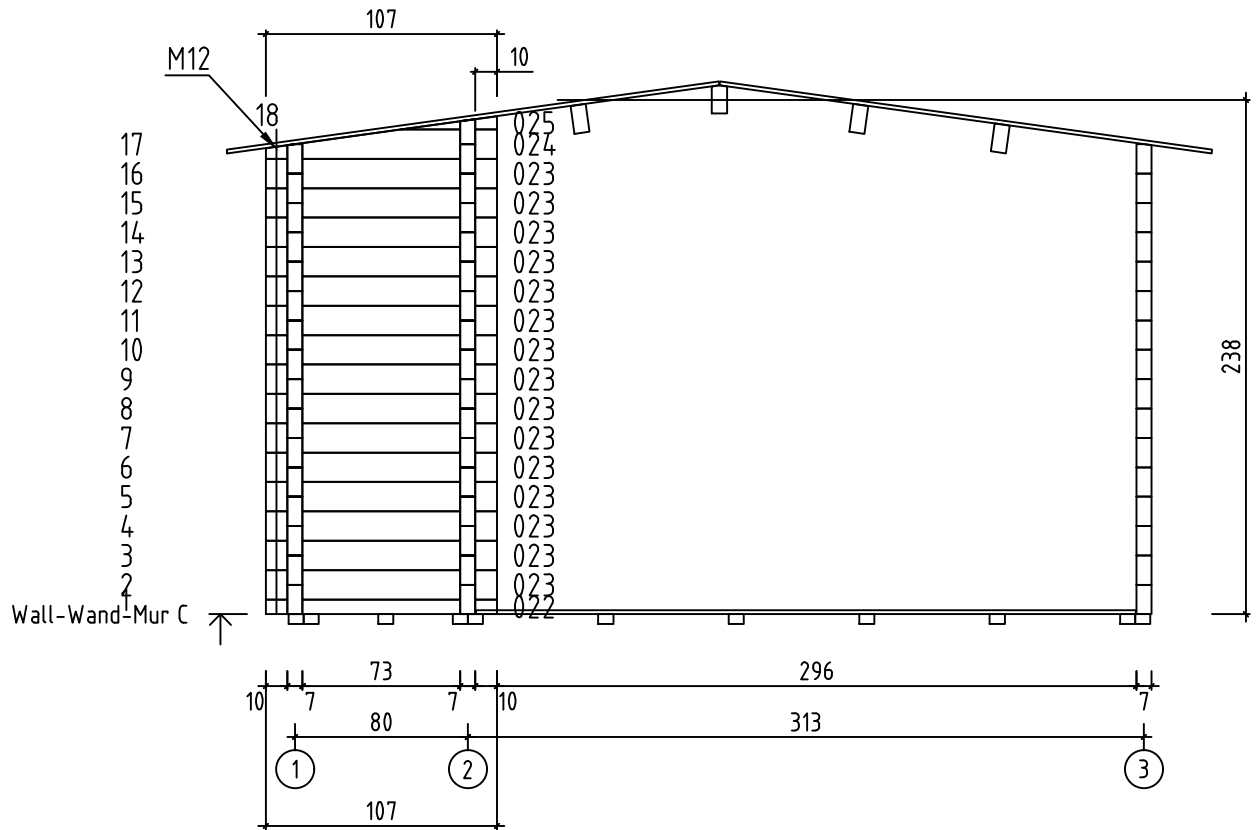
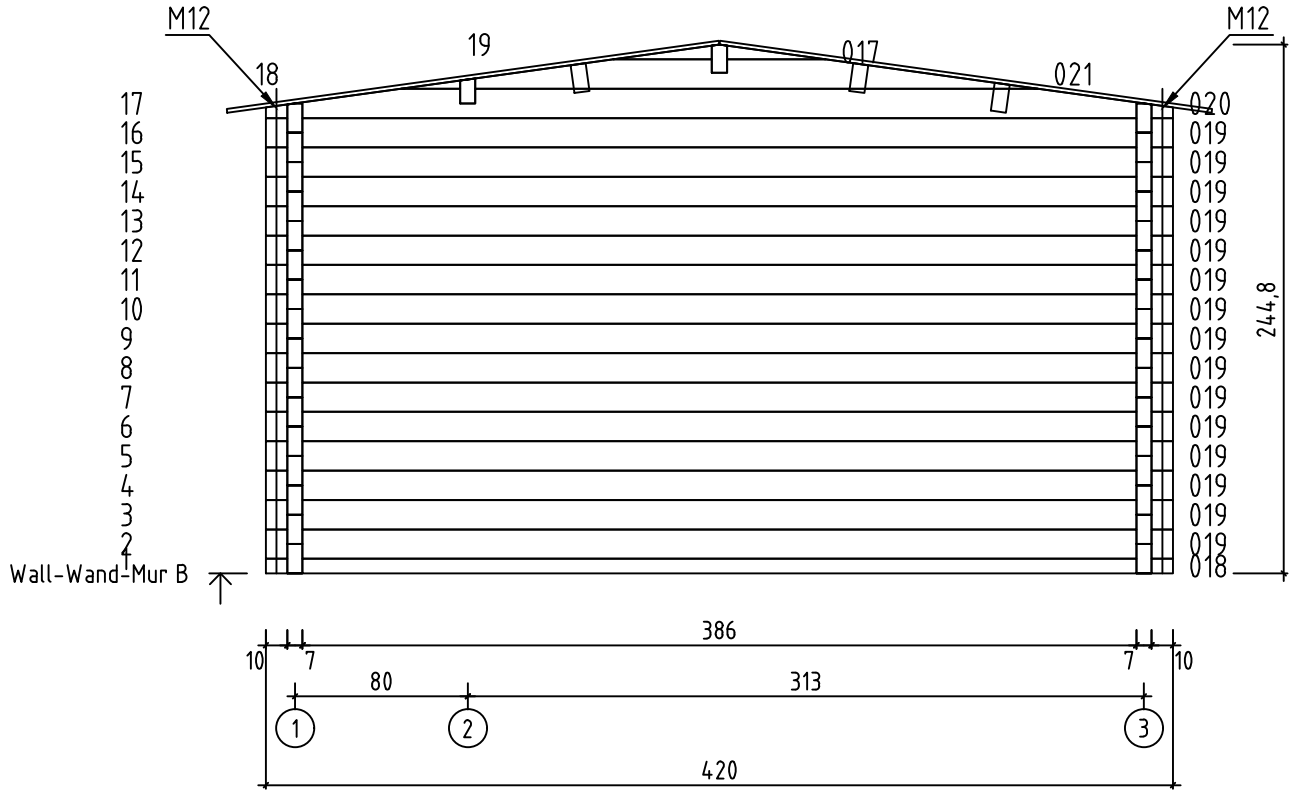

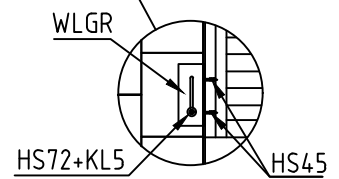
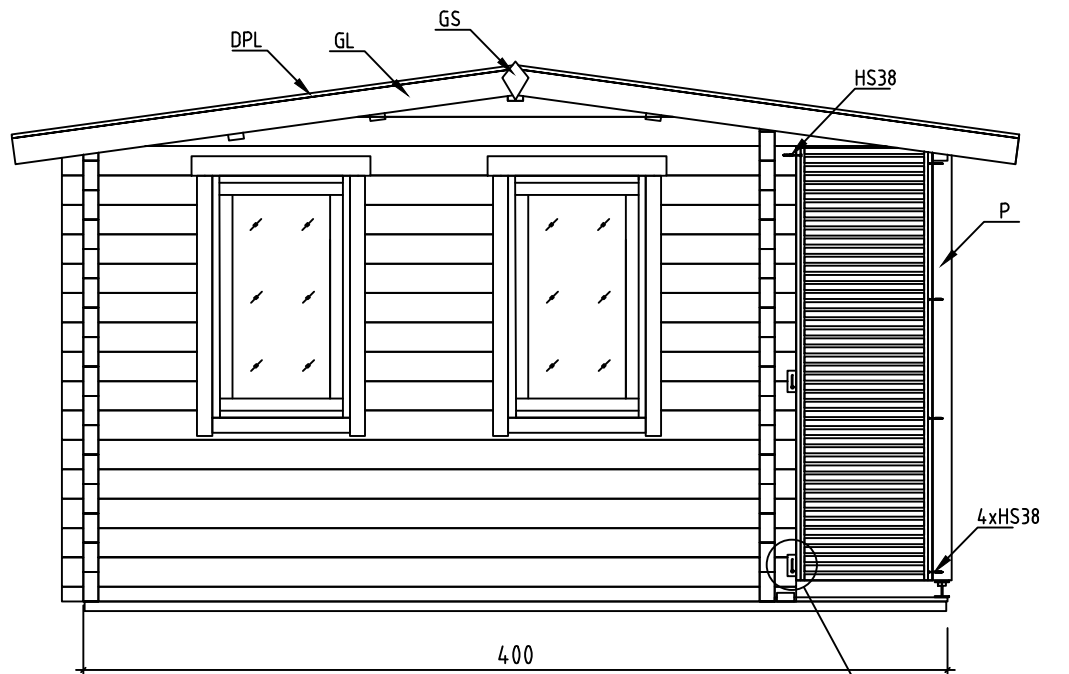
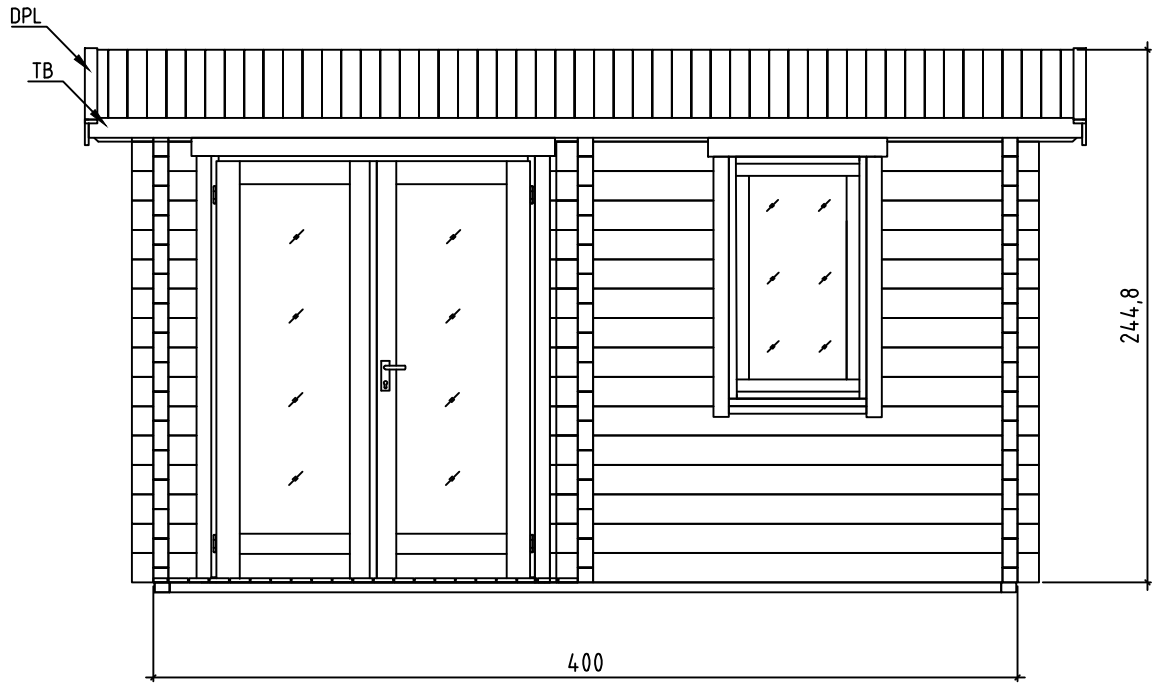

Dingwall, Art.No.70134.02

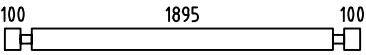
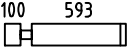
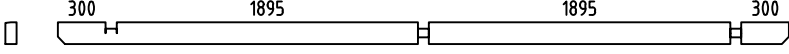

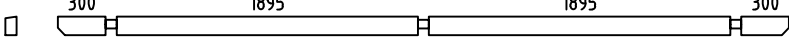
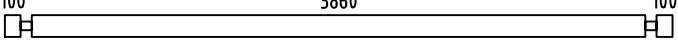
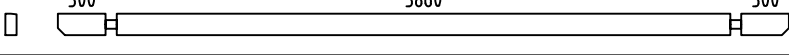
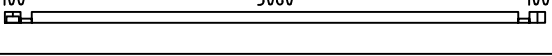
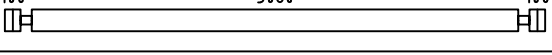
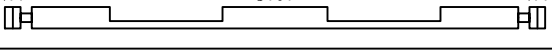
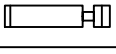
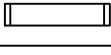
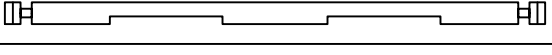
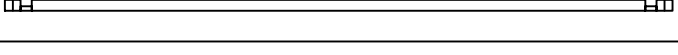
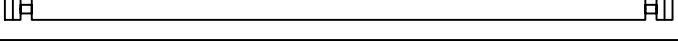
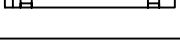
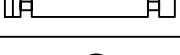
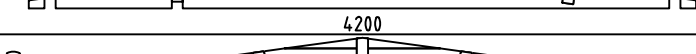
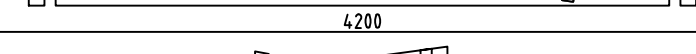
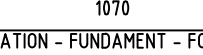
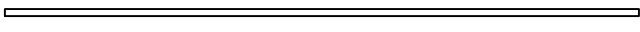
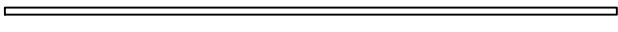

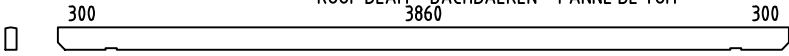
Dingwall, Art.No.70134.02

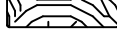

Pos	Dingwall, Art.No.7013402 Piece list - Stückliste - Liste des pieces	Q.	P (mm)	L (mm)
001		7	70x136	2235
002		18	70x136	763
003		1	70x136	4600
004		29	70x136	322
005		1	70x136	323
006		1	70x116	4600
007		15	70x136	4200
008		1	70x136	4600
009		1	70x68	3400
010		5	70x136	3400
011		1	70x136	3400
012		16	70x136	660
013		8	70x136	660
014		1	70x136	3400
018		1	70x68	4200
019		15	70x136	4200
022		1	70x68	1070
023		15	70x136	1070
WA-1		1		
WB-1		1		
WC-1		1		
IAR1	FOUNDATION - FUNDAMENT - FONDATION 	2	70x45	3990
IAR3	FOUNDATION - FUNDAMENT - FONDATION 	11	70x45	3850
IAR2	FOUNDATION - FUNDAMENT - FONDATION 	2	70x45	275
PR1	ROOF BEAM - DACHBALKEN - PANNE DE TOIT 	1	70x140	4600

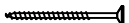
Pos	Dingwall, Art.No.7013402 Piece list - Stückliste - Liste des pieces	Q.	P (mm)	L (mm)
A-PR1	300 ROOF BEAM - DACHBALKEN - PANNE DE TOIT 3860 300 	3	70x140	4600
FB	FLOOR BOARDS - FUSSBODENBRETTER - LAME DE PLANCHER 	22	90x18	3856
FB	FLOOR BOARDS - FUSSBODENBRETTER - LAME DE PLANCHER 	21	90x18	3056
RB	ROOF BOARDS - DACHBRETTER - VOLIGES 	104	90x18	2300
SV	TERRACE BOARDS - TERRASSENBRETTER - PLANCHER DE TERRASSE 	21	90x19	800
	FLOOR FILLET-FUSSBODENLEISTE - CORNIERE DE FINITION DU PLANCHER 		15x40	15.4 m.
DPL	ROOFING FELT FILLET - DACHPAPPENLEISTE - BAGUETTE DE FIXATION DU FEUTRE BITUMEUX 	4	18x58	2350
M12	TREADED ROD M12 - GEWINDESTANGE M12 - TIGE FILETÉE M12 	4		195
M12	TREADED ROD M12 - GEWINDESTANGE M12 - TIGE FILETÉE M12 	1		265
M12	TREADED ROD M12 - GEWINDESTANGE M12 TIGE FILETÉE M12 	5		2000
LPL	FIXING FILLET - FIXIRUNGSLEISTE - PROFIL DE FIXATION 	6	20x70	662
LPL	FIXING FILLET - FIXIRUNGSLEISTE - PROFIL DE FIXATION 	6	20x70	1190
LPL	FIXING FILLET - FIXIRUNGSLEISTE - PROFIL DE FIXATION 	1	20x70	1540
LPL	FIXING FILLET - FIXIRUNGSLEISTE - PROFIL DE FIXATION 	2	20x70	2000
P	POST - PFOSTEN - POTEAU 	1	90x90	2010
TB	EAVES BOARD - TRAUFBRETT - BANDEAU DE TOIT 	2	18x90	4600
DRV	ROOF EDGE REINFORCEMENT - DACHRANDVERSTÄRKUNG - CORNIERE DE RENFORT DE BORD DE TOIT 	2	28x34	4600
TBE6	FIXING FILLET FOR WINDOW - FIXIRUNGSLEISTE FÜR FENSTER - PROFIL DE FIXATION DES FENETRES 	4	28x34	1020
TBE6	FIXING FILLET FOR WINDOW - FIXIRUNGSLEISTE FÜR FENSTER - PROFIL DE FIXATION DES FENETRES 	2	28x34	1190
TBE6	FIXING FILLET FOR DOOR - FIXIRUNGSLEISTE FÜR TÜR - PROFIL DE FIXATION DES PORTES 	2	28x34	2000
GL	GABLE MOULDING - GIEBELLEISTE PLANCHE DE RIVE 	4	18x120	2350
GS	GABLE SEGMENT-DECKBLATT - LOSANGE DE FINITION 	2		
KL4	LENGTHENING BOLT FOR TREADED ROD - VERLÄNGERUNGSMUTTER FÜR GEWINDESTANGE - MANCHON DE RACCORDEMENT DE TIGE FILETÉE 	5		
KL1	DRIVE NUT TREADED ROD - EINSHLAGMUTTER FÜR GEWINDESTANGE - ÉCROU A FRAPPER POUR TIGE FILETÉE 	5		
KL2	NUT FOR TREADED ROD - MUTTER FÜR GEWINDESTANGE - ÉCROU POUR TIGE FILETÉE 	5		

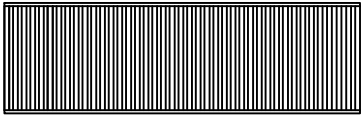
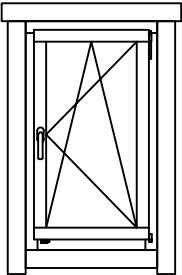
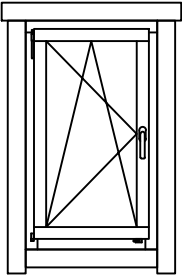
Pos	Dingwall, Art.No.7013402 Piece list - Stückliste - Liste des pieces	Q.	P (mm)	L (mm)	
KL3	PLAIN WASHER TREADED ROD - UNTERLEGSCHIEBE FÜR GEWINDESTANGE - RONDELLE PLATE POUR TIGE FILETÉE		5		
HS12	SCREW FOR GABLE SEGMENT - SCHRAUBEN FÜR DECKBLATT - VIS POUR FIXATION LOSANGE DE FINITION		4	3.5x35	
HS83	SCREW FOR FIXING FILLET - SCHRAUBEN FÜR FIXIRUNGSLEISTE - VIS POUR PROFIL DE FIXATION		63	3.5x50	
HS84	SCREW FOR FIXING FILLET - SCHRAUBEN FÜR FIXIRUNGSLEISTE - VIS POUR PROFIL DE FIXATION		34	3.5x50	
HS16	SCREW FOR GABLE MOULDING - SCHRAUBEN FÜR GIEBELLEISTE - VIS DE FIXATION POUR PLANCHE DE RIVE		32	3.5x50	
HS38	SCREW FOR FIXING TERRACE RAILING - SCHRAUBE FÜR TERRASSE VIS DE FIXATION DE GARDE-CORPS DE TERRASSE		5	4.5x80	
HS45	SCREW FOR SLIDING WALL TIE - SCHRAUBEN FÜR WAND SCHIEBEREGLER - VIS POUR FIXATION ÉQUERRE MÉTALLIQUE AU PARAVENT		8	4x20	
HS32	SCREW FOR EAVES BOARDS - SCHRAUBEN FÜR TRAUFBRETTER - VIS DE FIXATION POUR BANDEAU DE TOIT		20	4x40	
HS26	SCREW FOR ROOF EDGE REINFORCEMENT - SCHRAUBEN FÜR DACHRANDVERSTÄRKUNG - VIS POUR RENFORT DE BORD DE TOIT		20	4x40	
HS34	SCREW FOR POST - SCHRAUBEN FÜR PFOSTEN - VIS DE FIXATION DES POTEAUX		2	4x60	
HS40	SCREW FOR 1. WALL BEAM - SCHRAUBE FÜR 1. BOHLENREIHE - VIS DE FIXATION DES FONDATIONS		10	5x120	
HS39	SCREW FOR FUNDAMENT - SCHRAUBEN ZUR BEFESTIGUNG FUNDAMENT - VIS POUR FONDATION		47	5x120	
HS42	SCREW FOR GABLE - SCHRAUBEN FÜR GIEBEL - VIS POUR FIXATION DES PIGNONS		5	5x120	
HS43	SCREW FOR ROOF BEAMS - SCHRAUBEN FÜR DACHBALKEN - VIS POUR PANNE DE TOIT		8	5x120	
HS49	SCREW FOR POST HEIGHT ADJUSTMENT - SCHRAUBEN FÜR REGULIERUNGSSCHRAUBE FÜR PFOSTEN - VIS DE FIXATION DE SUPPORT RÉGLABLE DE POTEAU		8	6x50	
MS	SCREW FOR DOORSTEP - SCHRAUBEN FÜR TÜRSCHWELLE - VIS DE FIXATION DU SEUIL DE PORTE		3	4.5x65	
HS72	SCREW FOR SLIDING WALL TIE - SCHRAUBEN FÜR WAND SCHIEBEREGLER - VIS POUR FIXATION ÉQUERRE MÉTALLIQUE AU PARAVENT		2	5x60	
SH70	HAMMER BLOCK - SCHLAGHOLZ - CALLE DE FRAPPE		1		
NFD	ZN NAIL FOR ROOFING FELT FILLET - ZN NÄGEL FÜR DACHPAPPENLEISTE - POINTE POUR BAGUETTE FIXATION FEUTRE BITUMEUX		24	2x40	
NF3	ZN NAIL FOR TERRACE - ZN NÄGEL FÜR TERRASSENBRETTER - POINTE POUR PLANCHER DE TERRASSE		126	2x50	
NFF	ZN NAIL FOR FLOOR FILLETS - ZN NÄGEL FÜR FUSSBODENLEISTEN - POINTE POUR PANNEAUX DE PLANCHER		31	1.4x40	
NF2	ZN NAIL FOR ROOF - ZN NÄGEL FÜR DACHBRETTER - POINTE POUR TOIT		450	2x50	
NH1	ZN NAIL FOR FLOOR - ZN NÄGEL FÜR FUSSBODENBRETTER - CLOUS POUR PLANCHER		340	2x50	
KL5	PLAIN WASHER FOR SLIDING WALL TIE - UNTERLEGSCHIEBE FÜR WAND SCHIEBEREGLER - RONDELLE POUR SABOT MÉTALLIQUE		2		
WLGR	SLIDING WALL TIE - SCHIEBEREGLER FÜR WAND - EQUERRE MÉTALLIQUE DE FIXATION DU PARAVENT		2		

Pos	Dingwall, Art.No.7013402 Piece list - Stückliste - Liste des pieces	Q.	P (mm)	L (mm)
RFP	POST HEIGHT ADJUSTMENT - REGULIERUNGSSCHRAUBE FÜR PFOSTEN - SUPPORT RÉGLABLE DE POTEAU	1		
ORZ	MONTAGE SET FOR DOORS AND WINDOWS - MONTAGE-SET FÜR TÜREN UND FENSTER - JEU DE MONTAGE PORTES ET FENETRES	1		
TRR2	TERRACE RAILING - TERRASSE - GARDE-CORPS DE TERRASSE 	1	630	2002
2+ A.0P.d	WINDOW-FENSTER-FENETRE 702x1190 	2		
2+ A.0V.d	WINDOW-FENSTER-FENETRE 702x1190 	1		
2+ TU .10P.b	DOOR-TÜR-PORTE 1580x2000 	1		

