

7.6x6.3
Plan

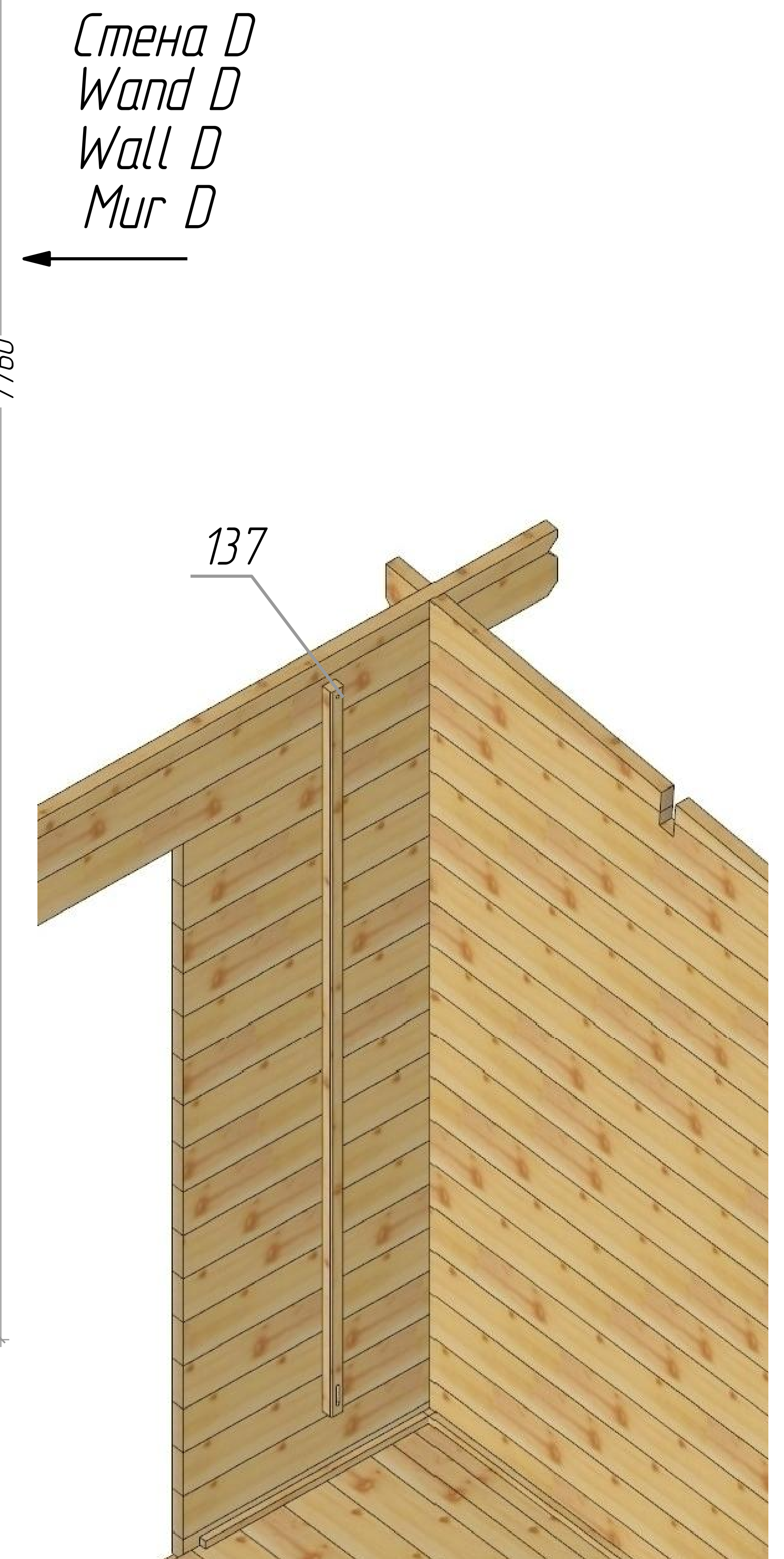

7.6x6.3

A

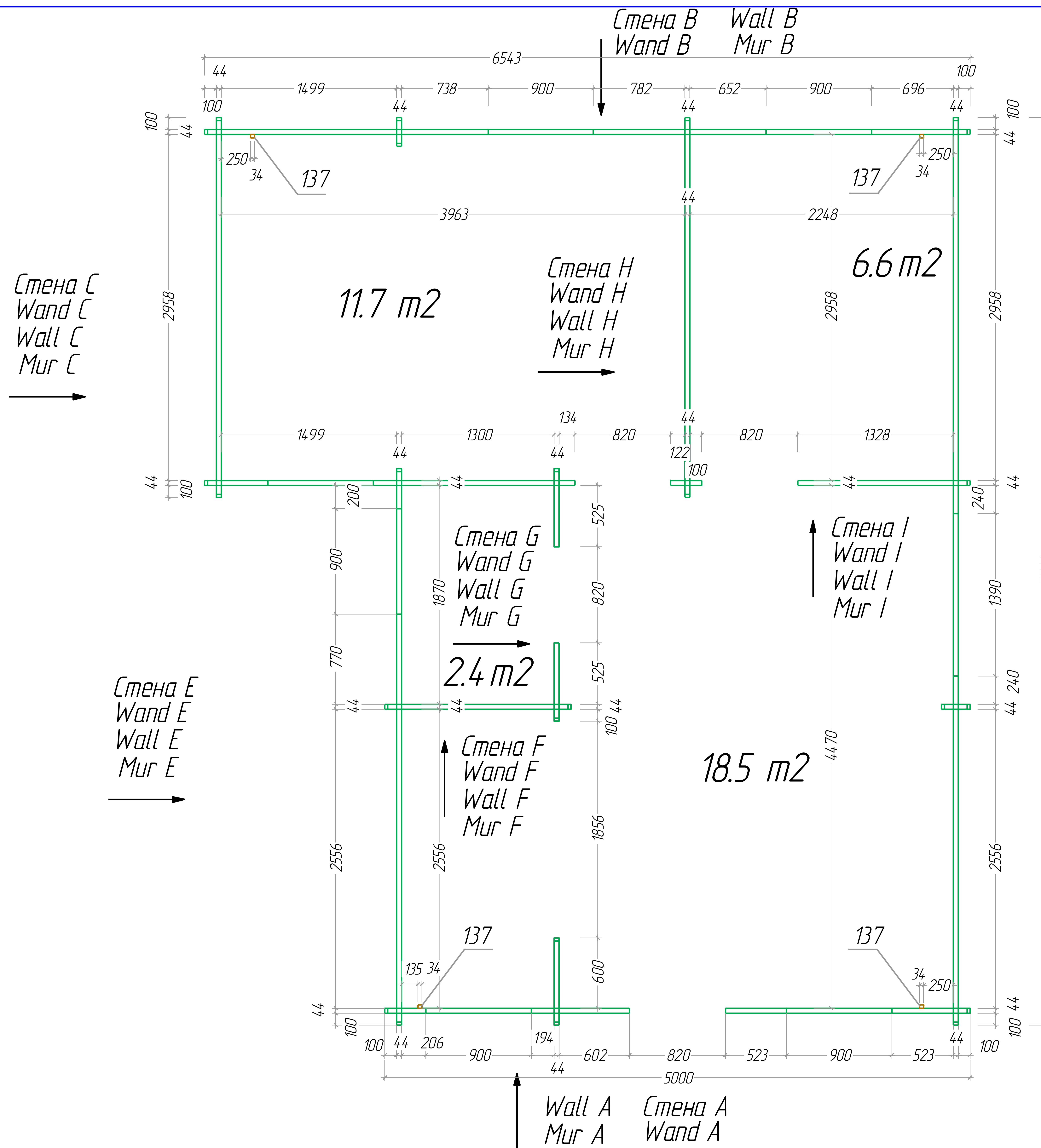
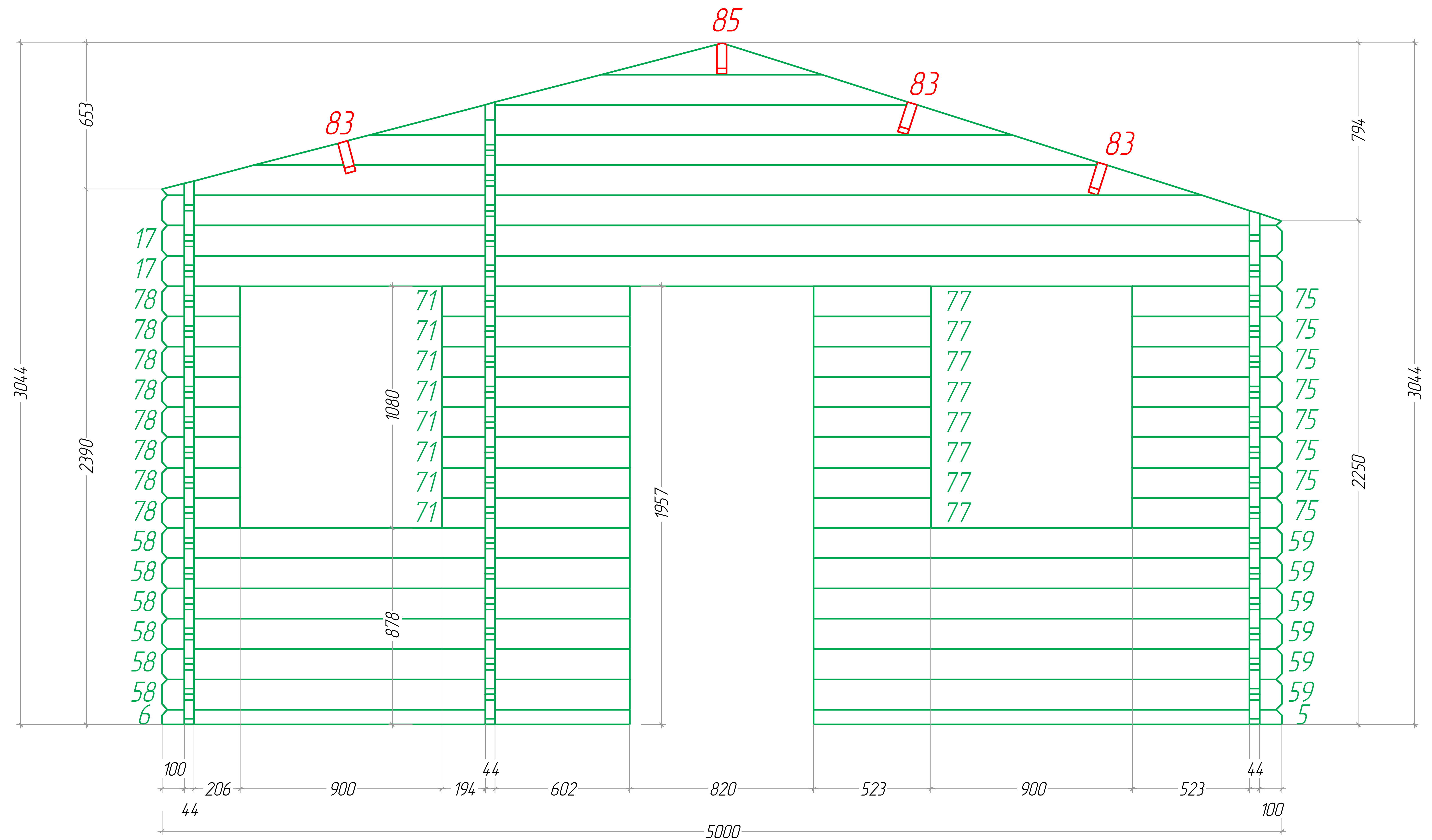

7.6x6.3

(B)

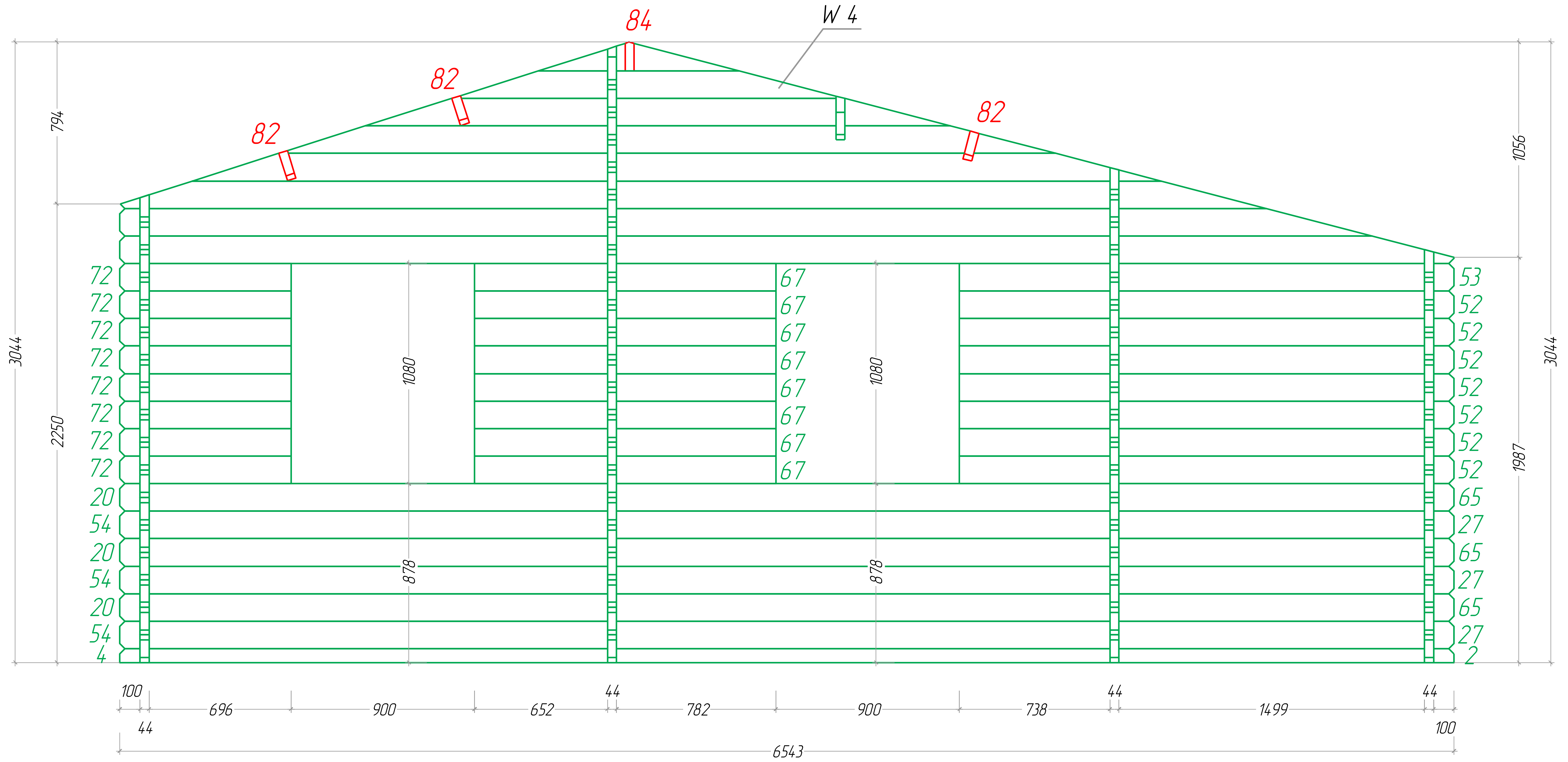

7.6x6.3

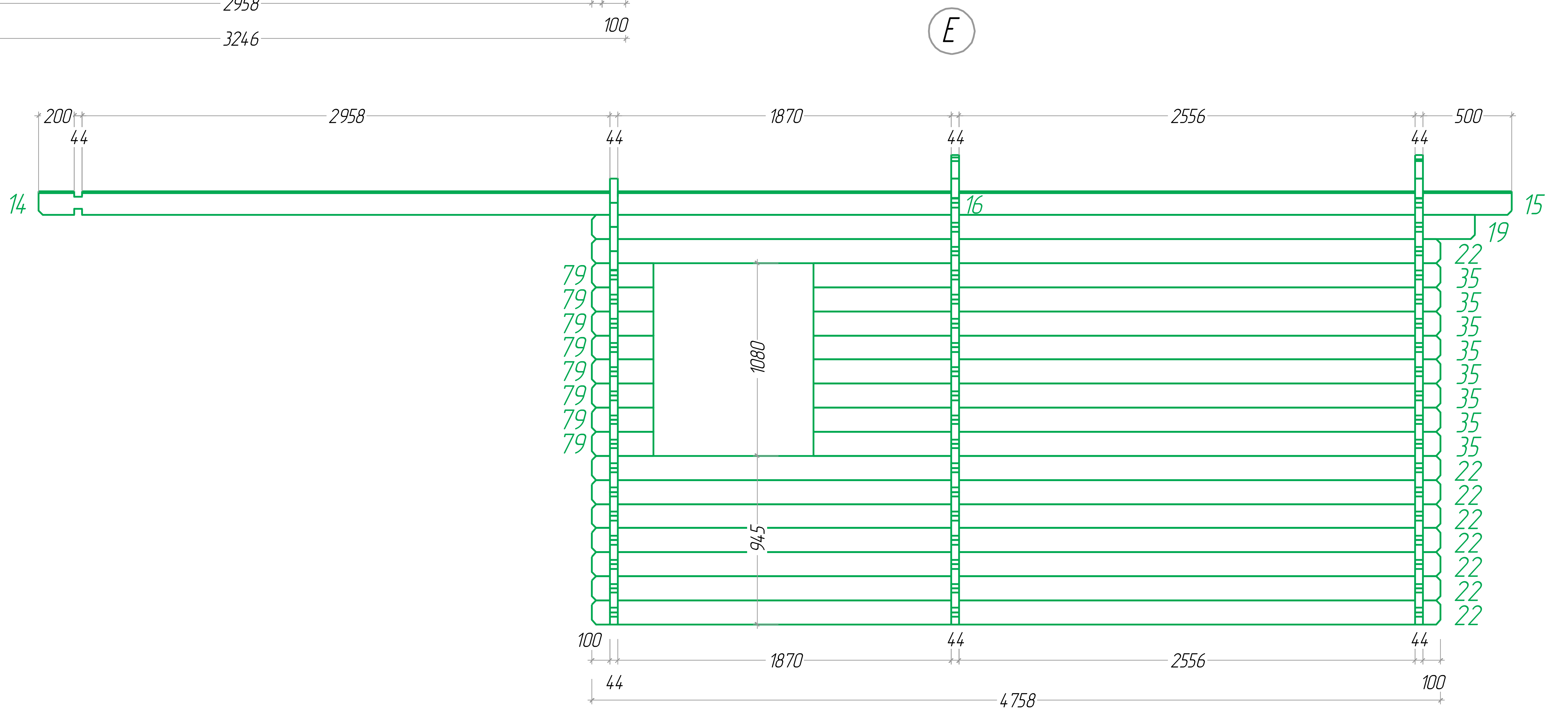
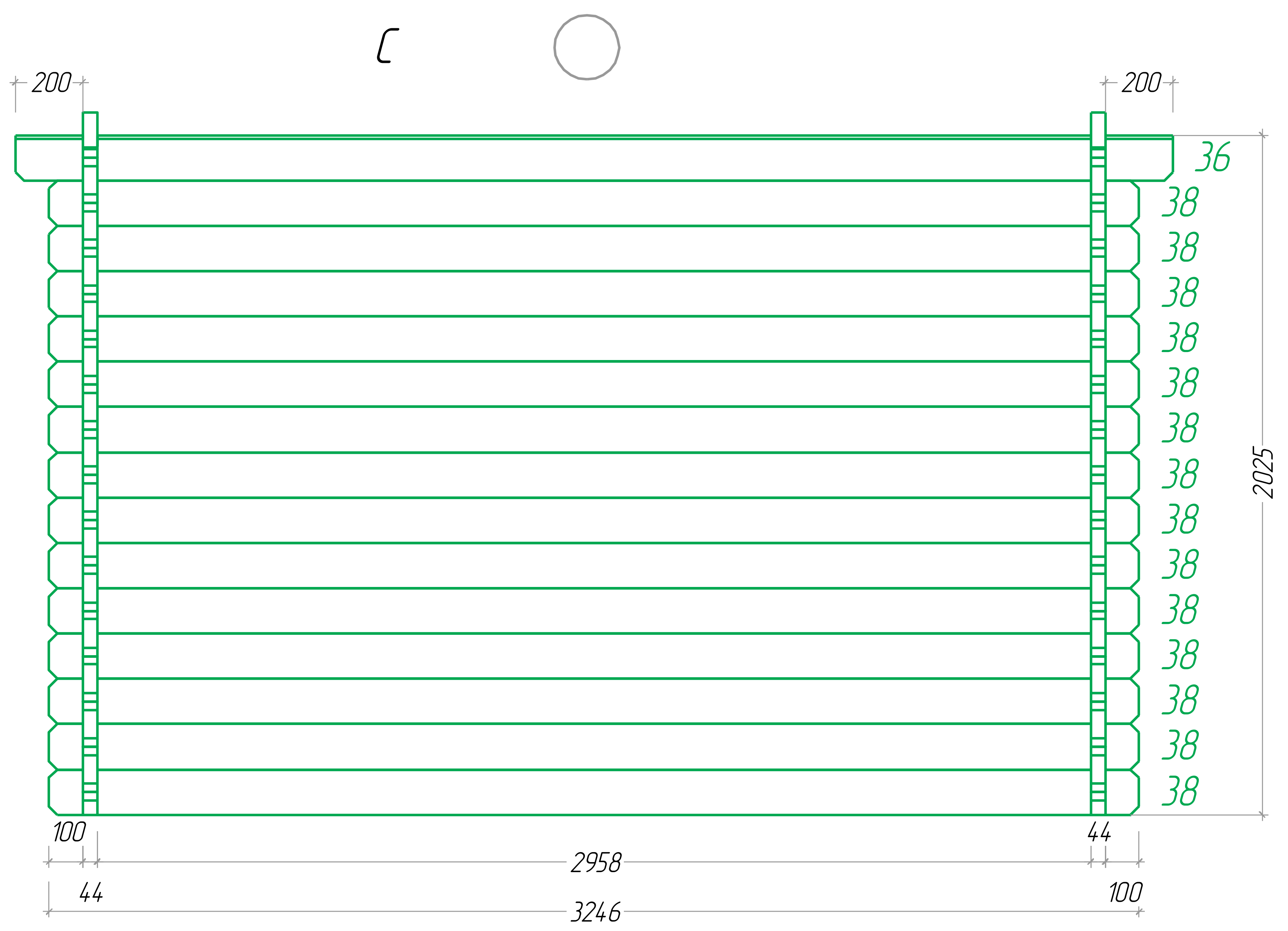

F

7.6x6.3

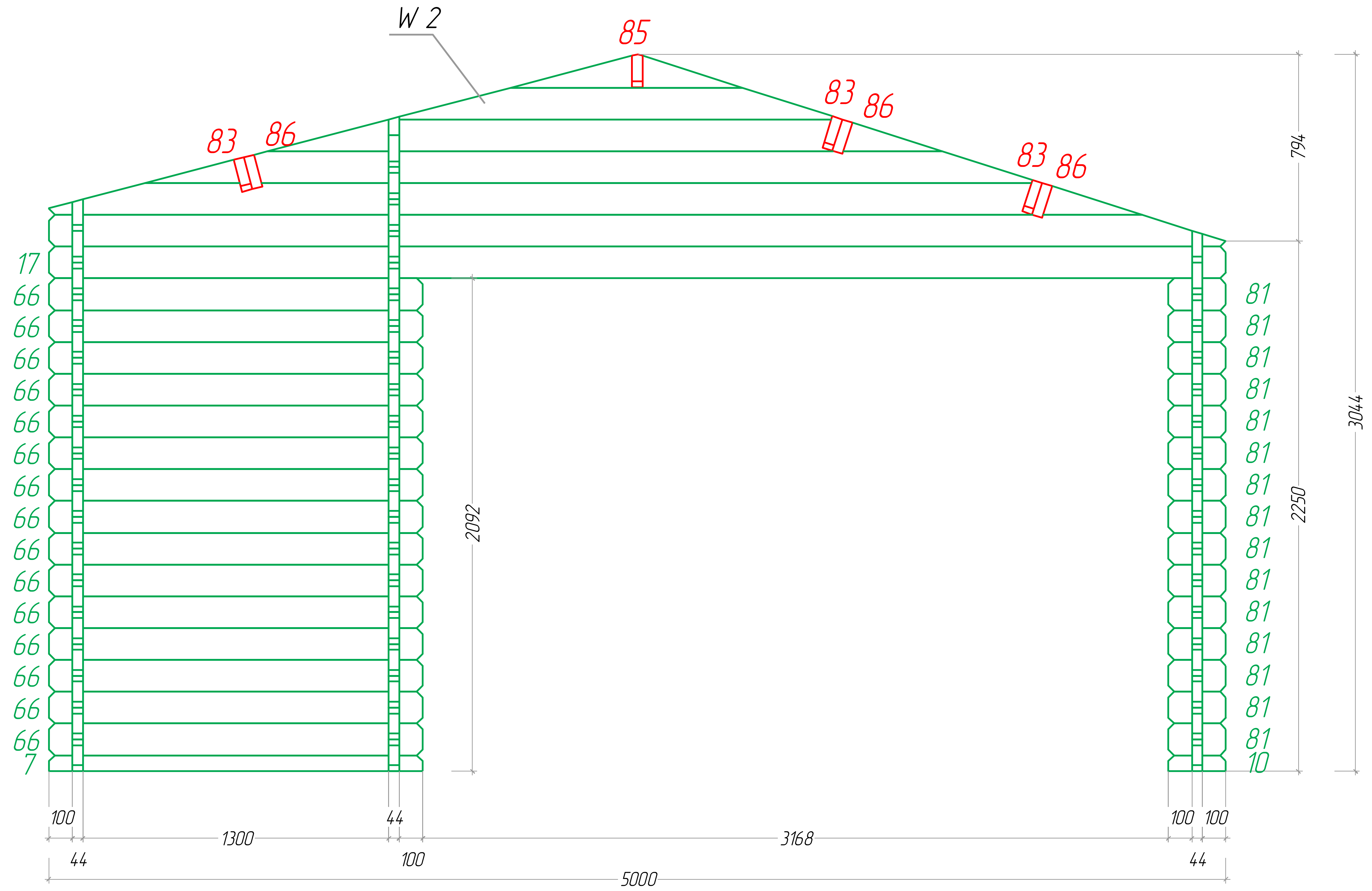

7.6x6.3

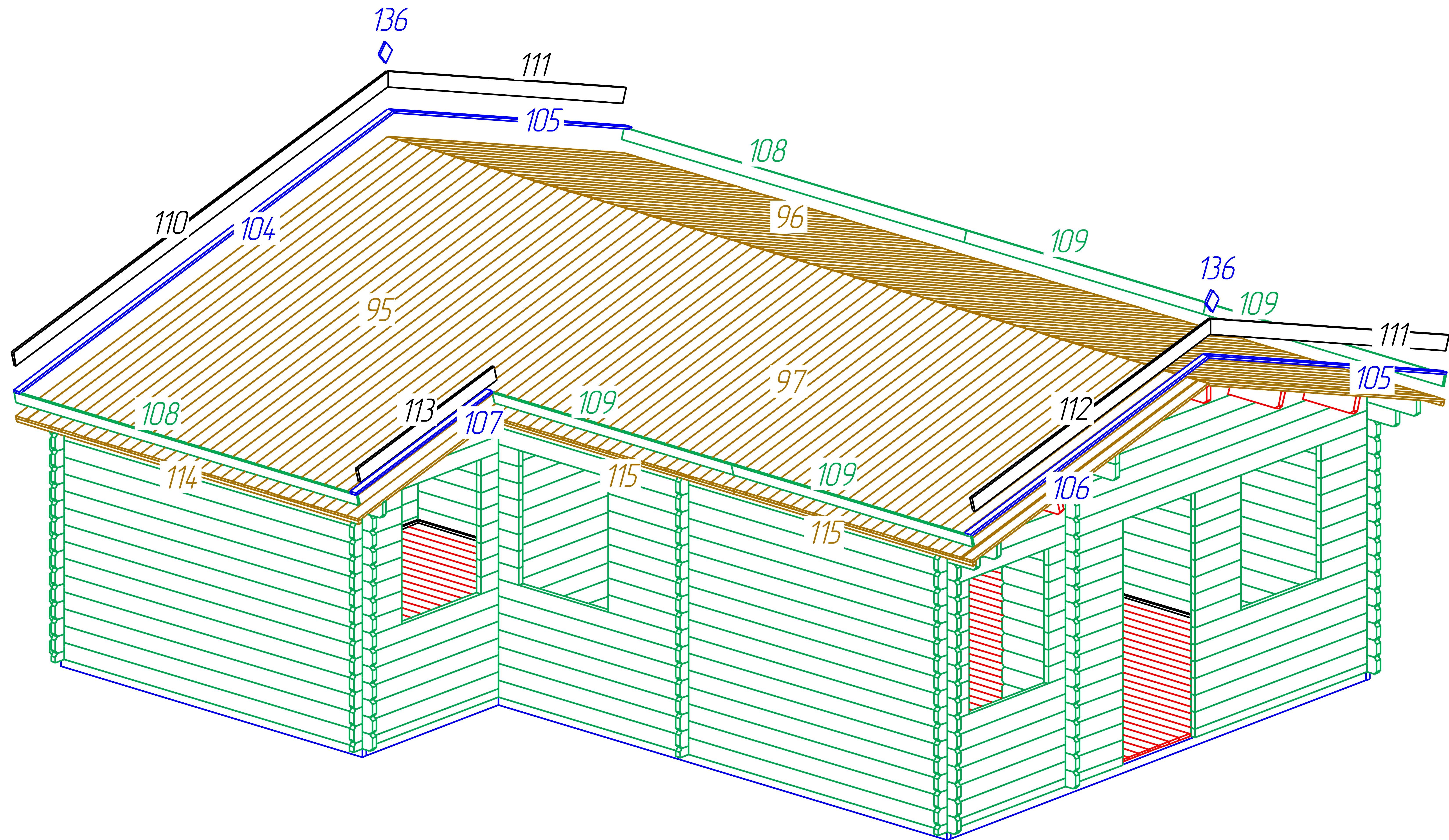

7.6x6.3

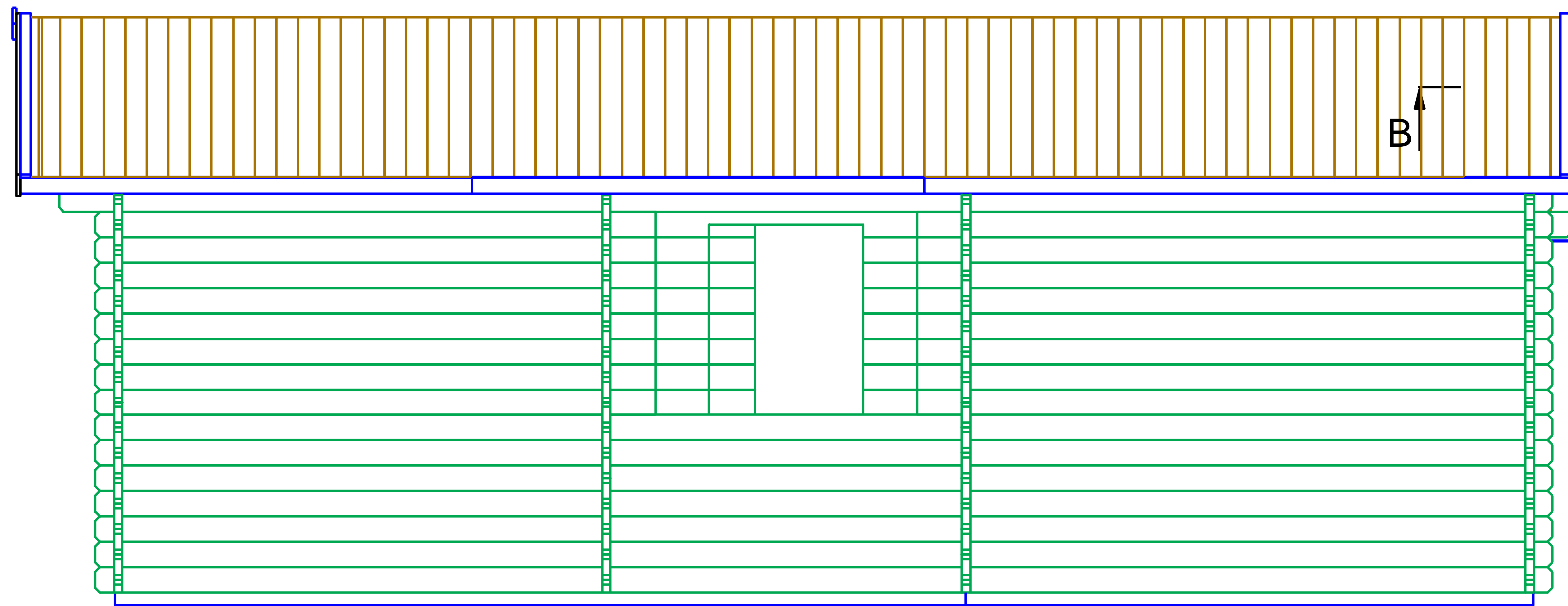

B

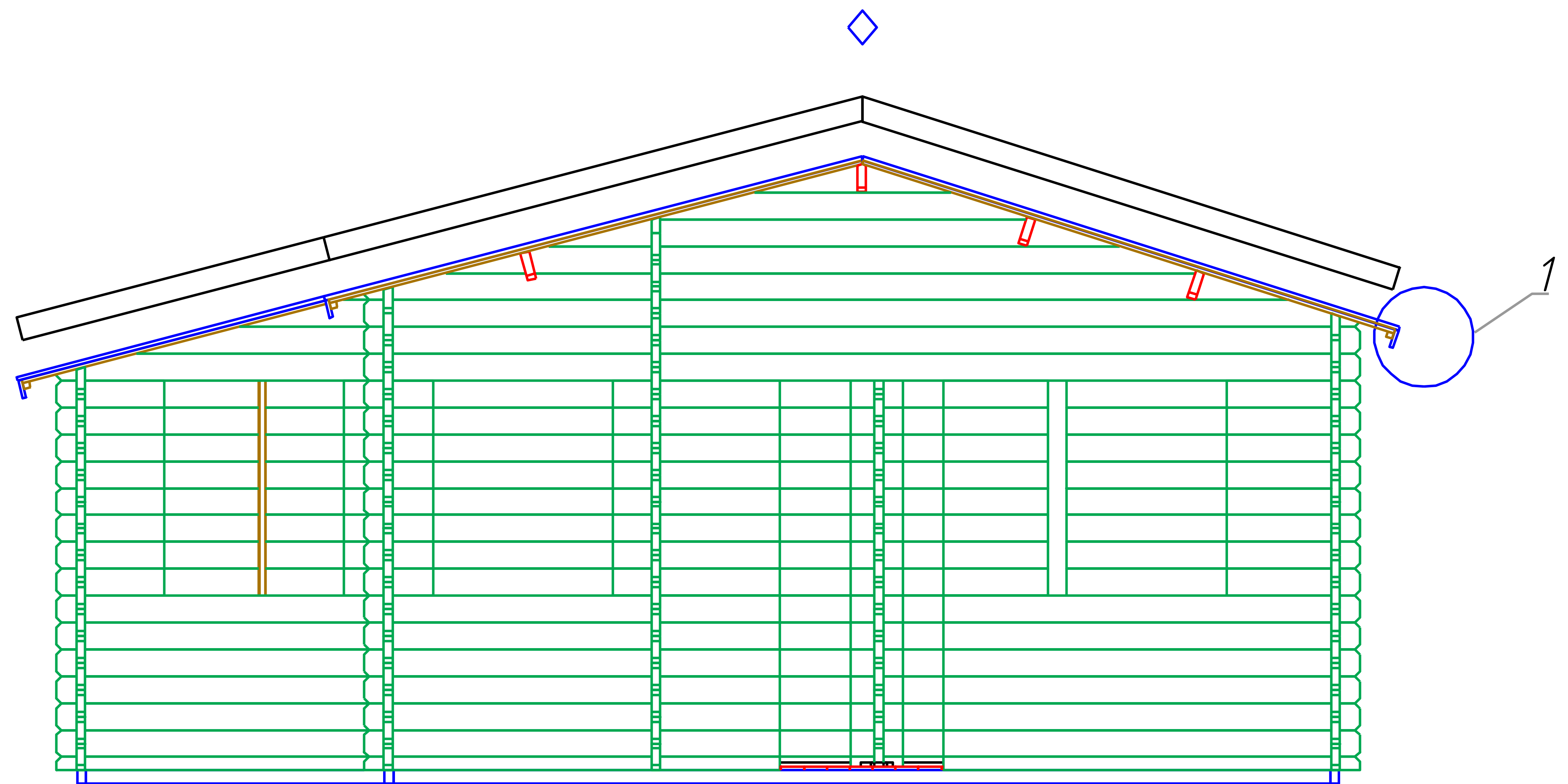
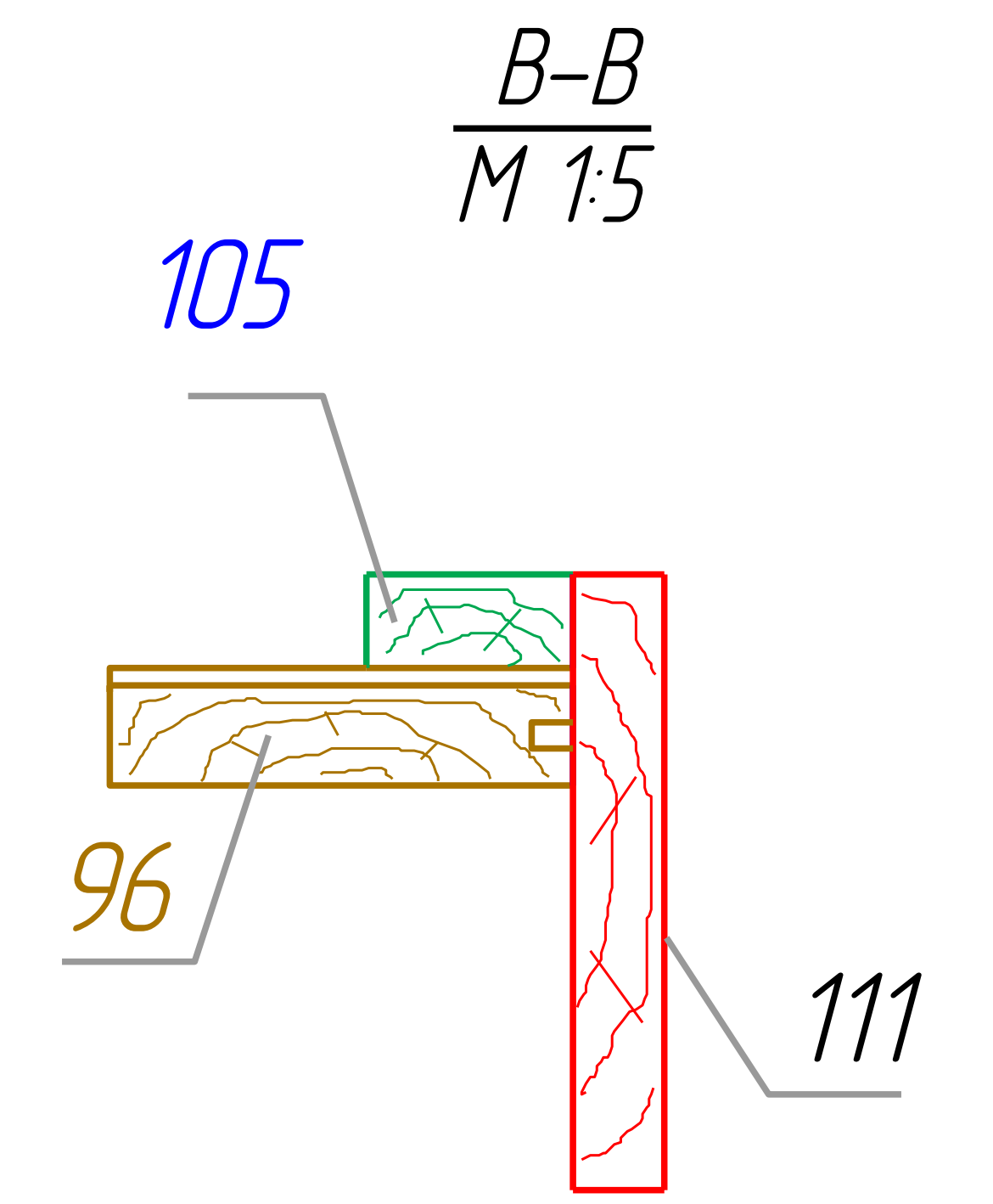

1
M 1:5

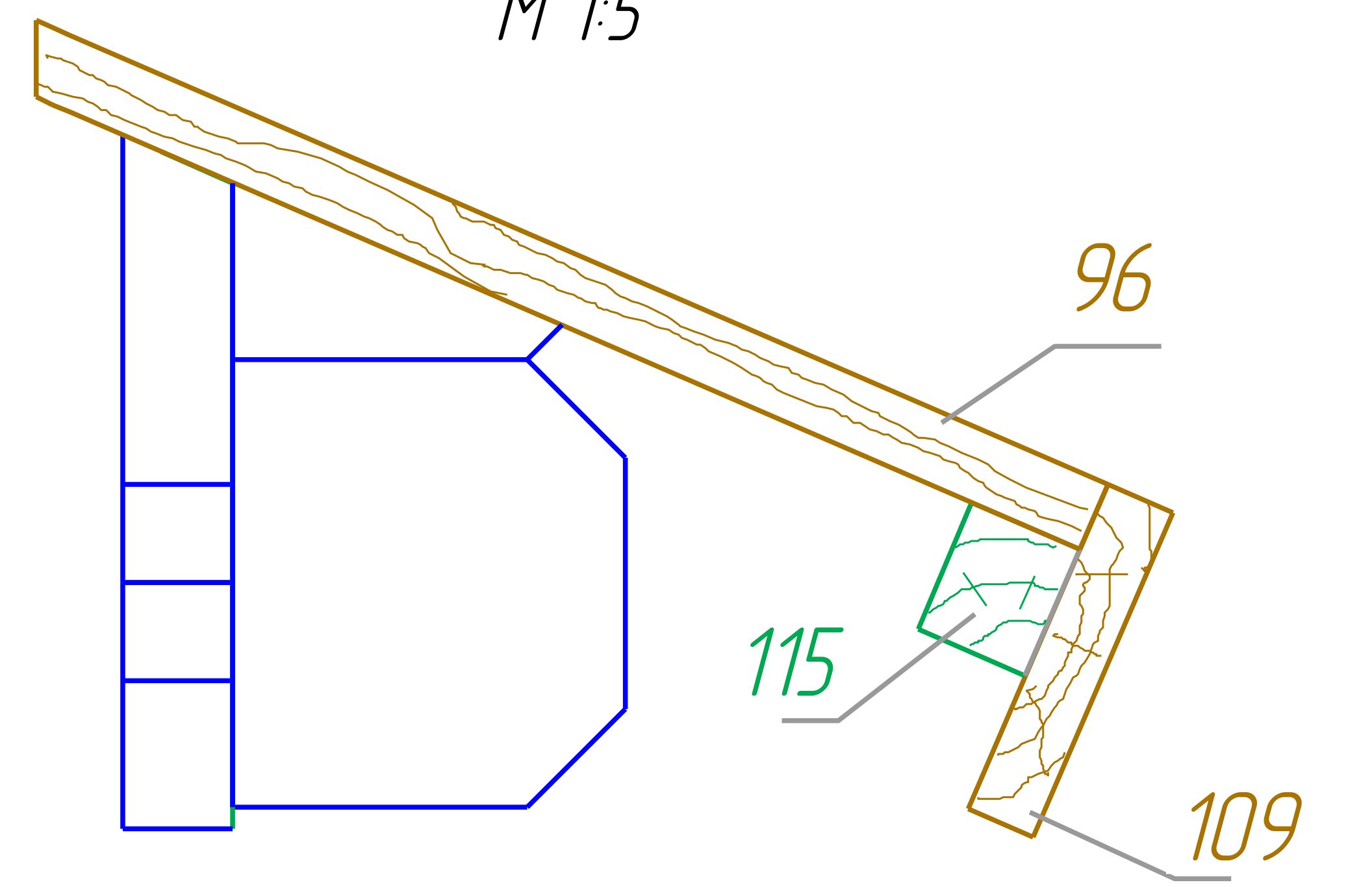





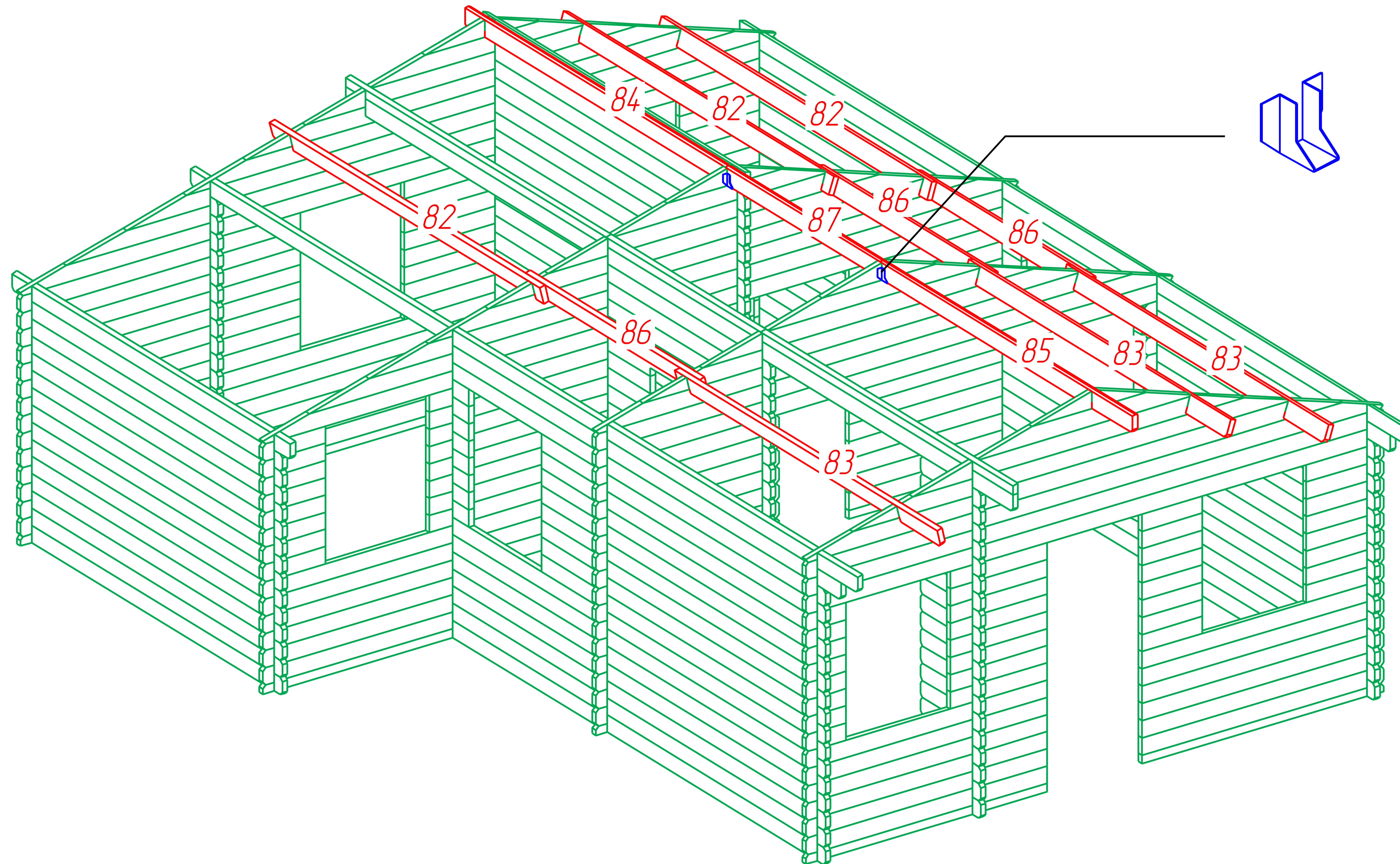

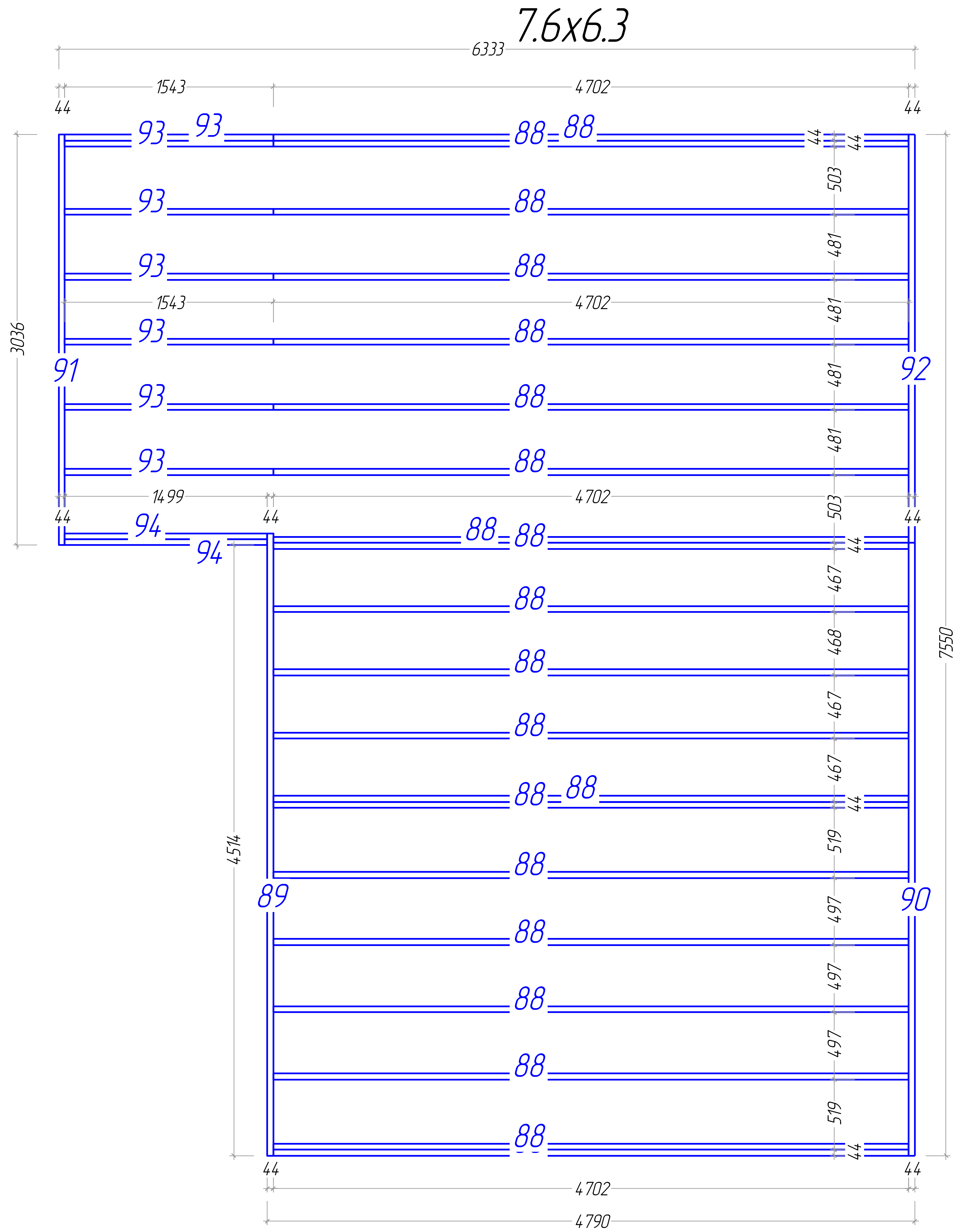
7.6x6.3

Roof beam
Dachbalken
Panne

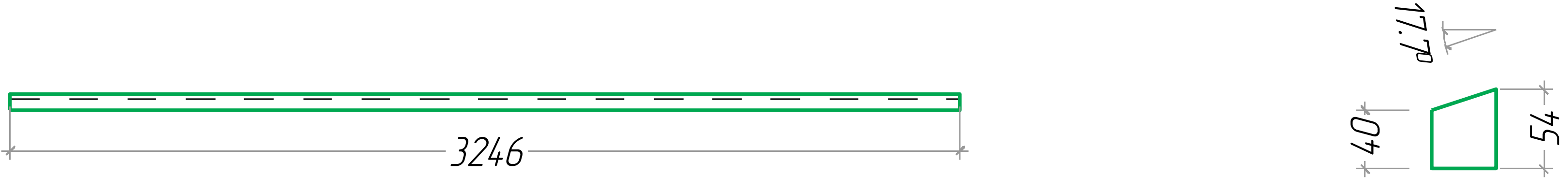
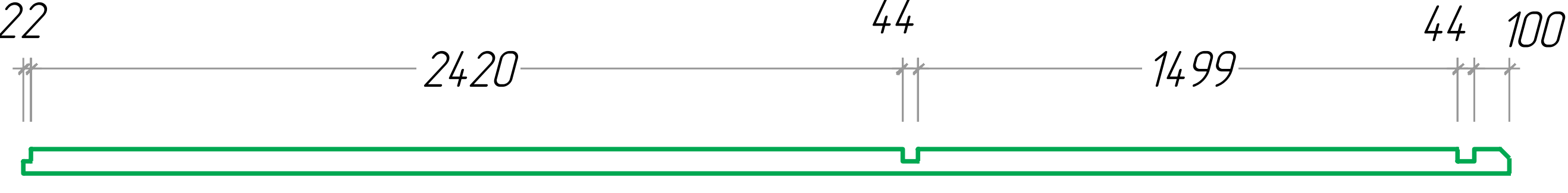
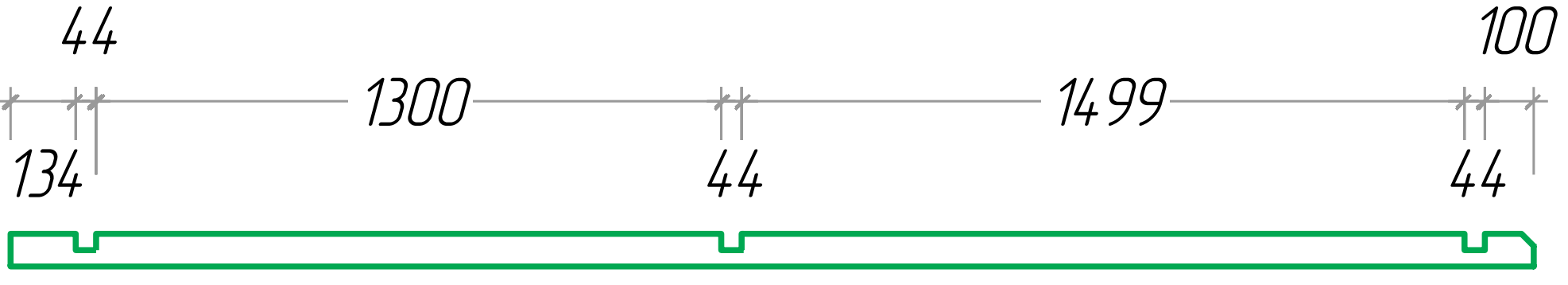
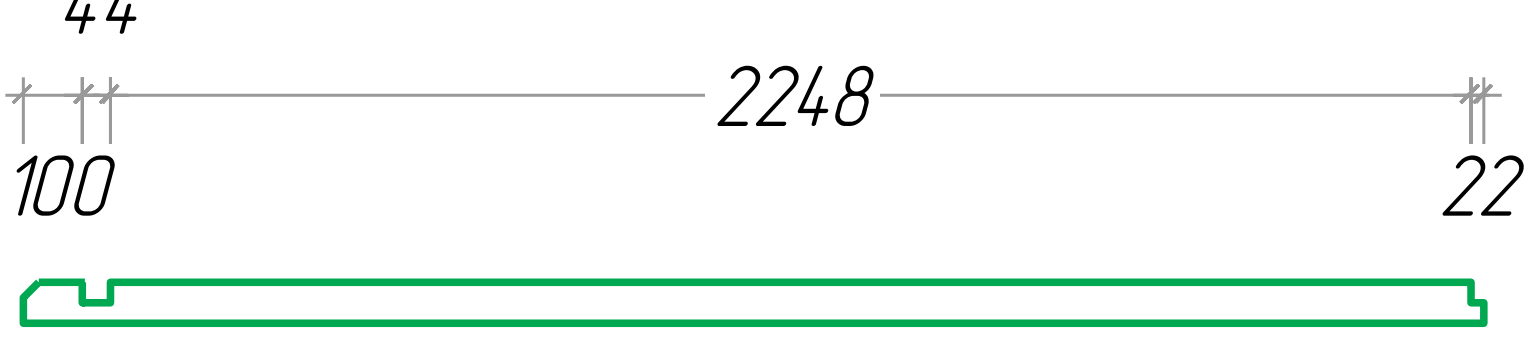
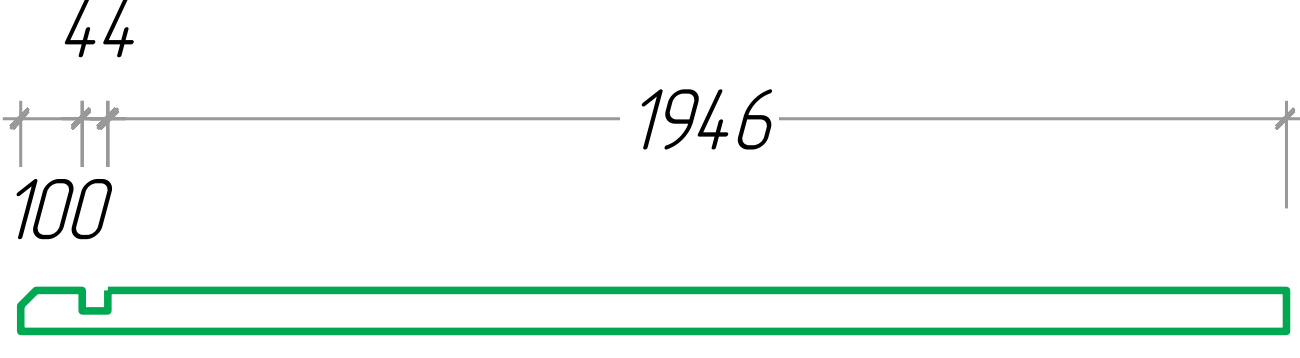

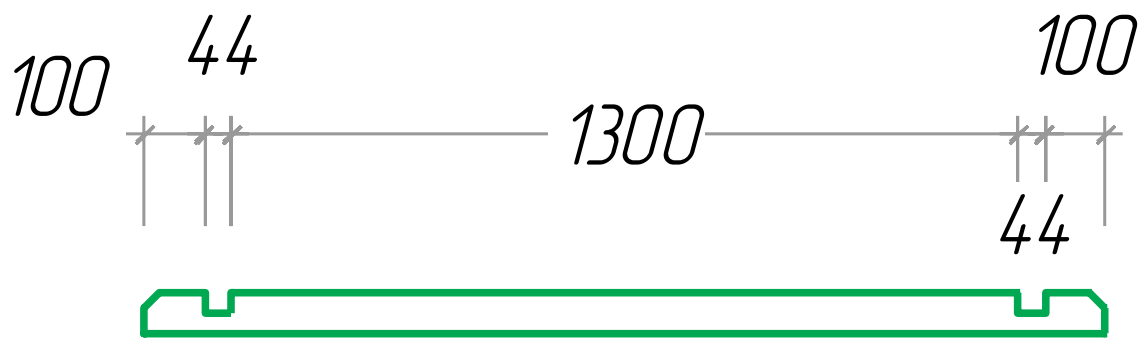

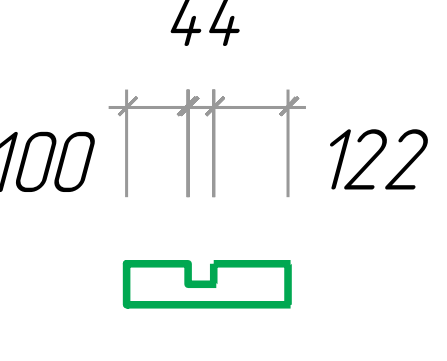
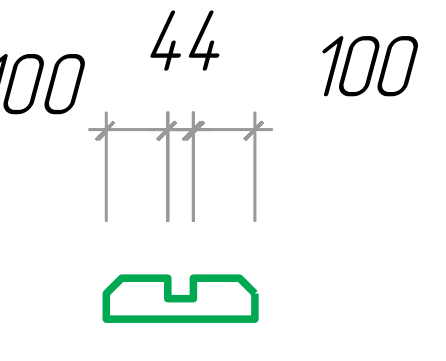

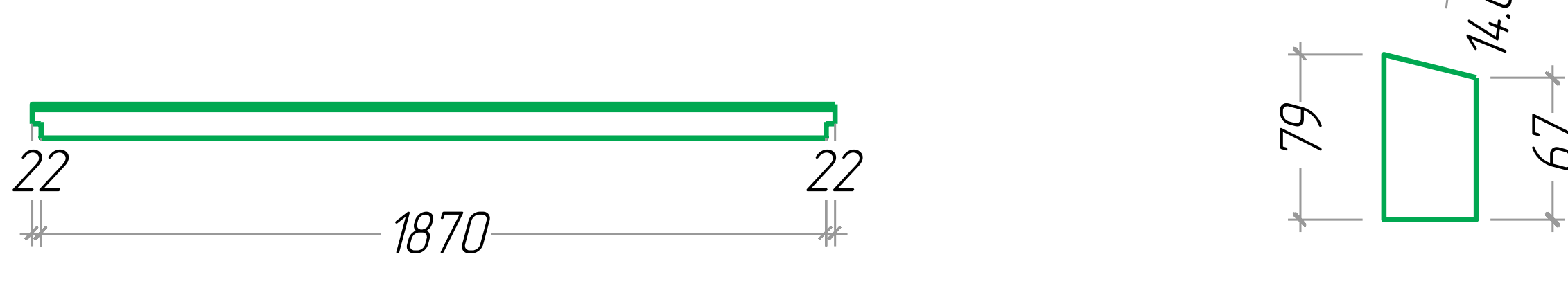

Boarding joist plan
Trummplan
Lambourde plan



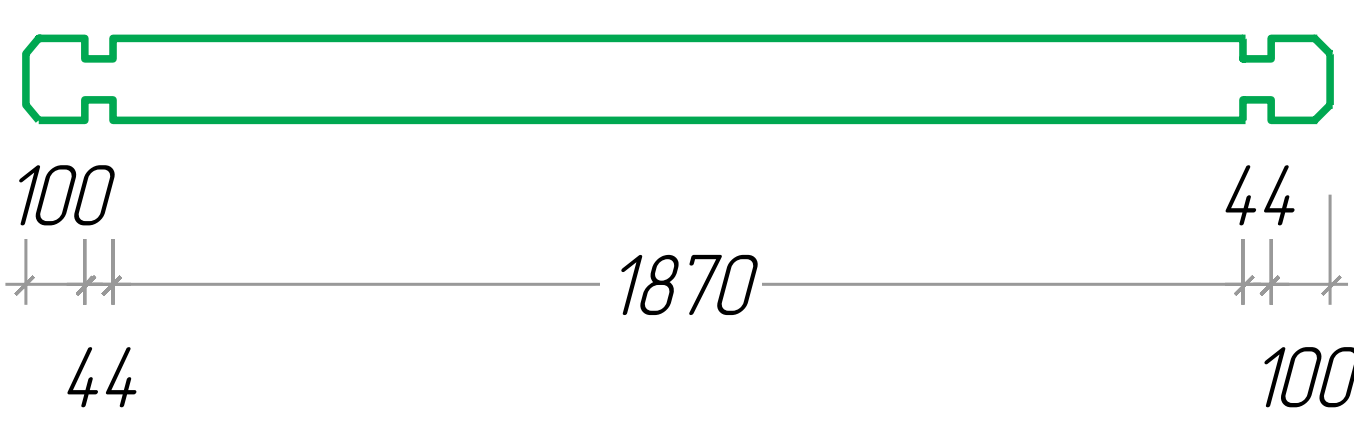
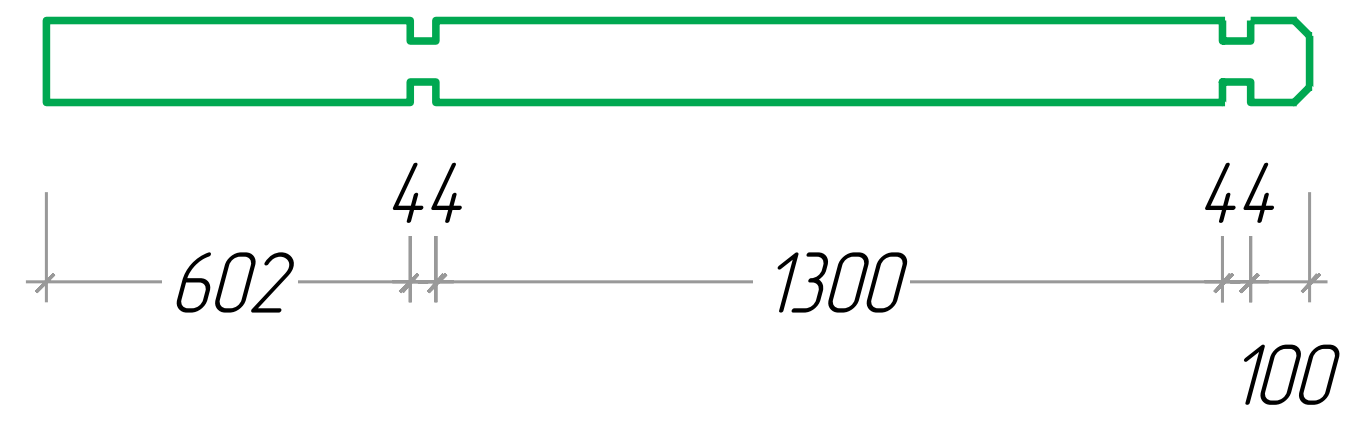

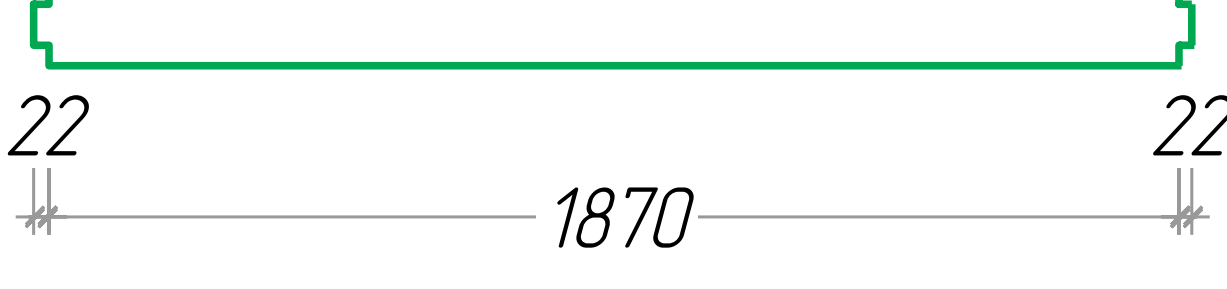
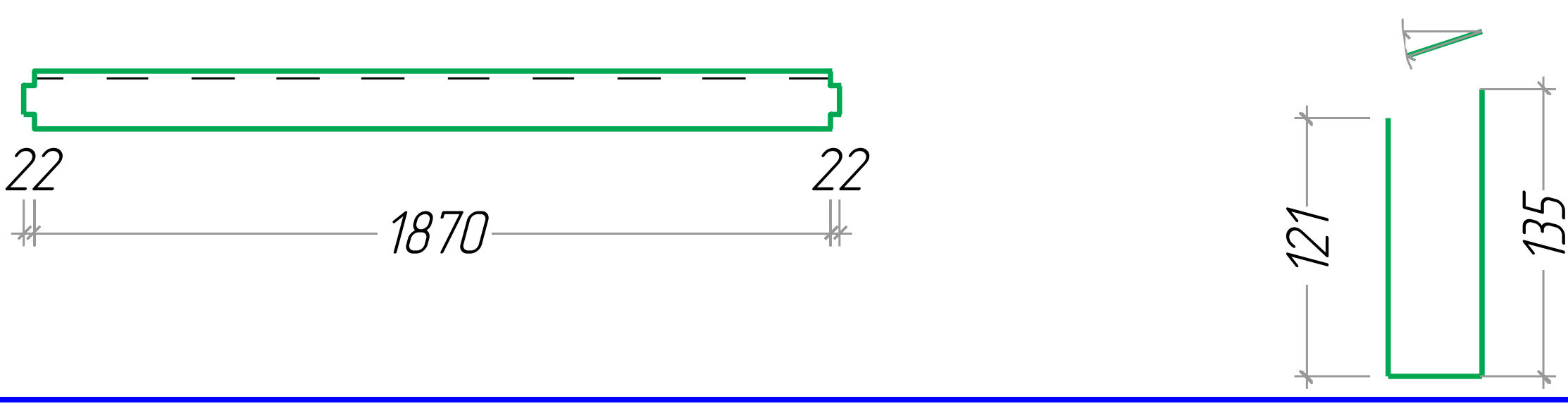
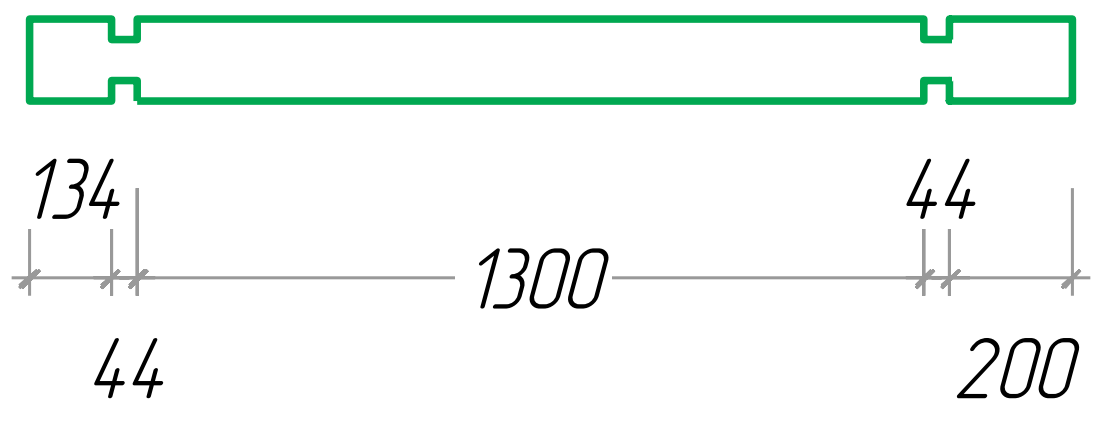

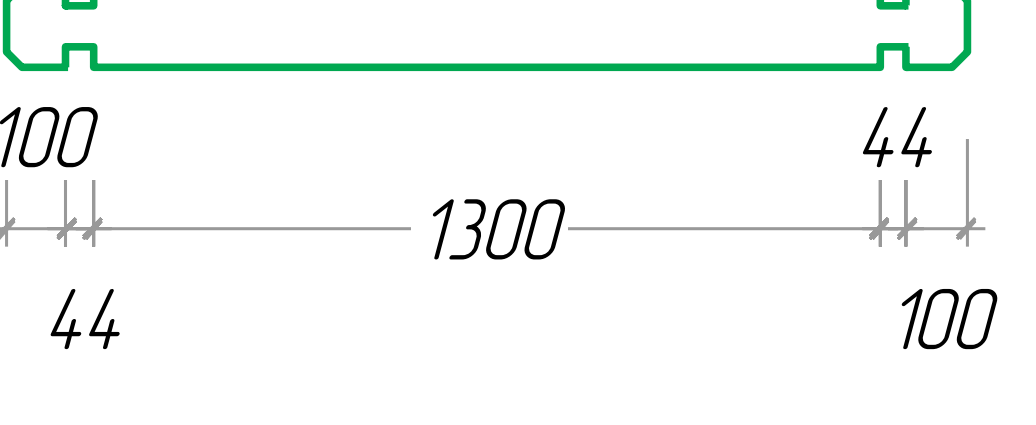
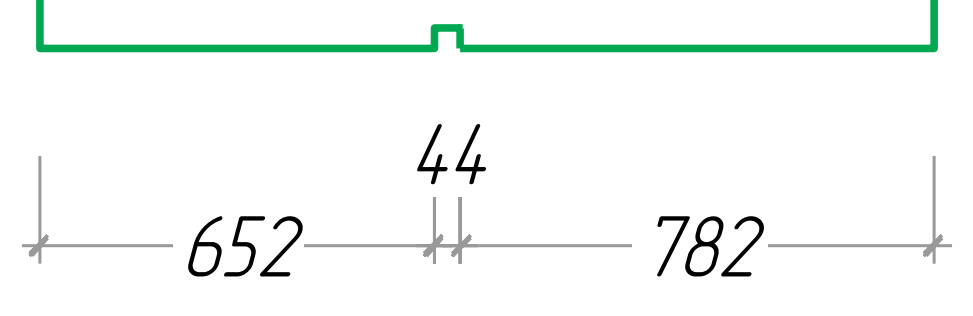
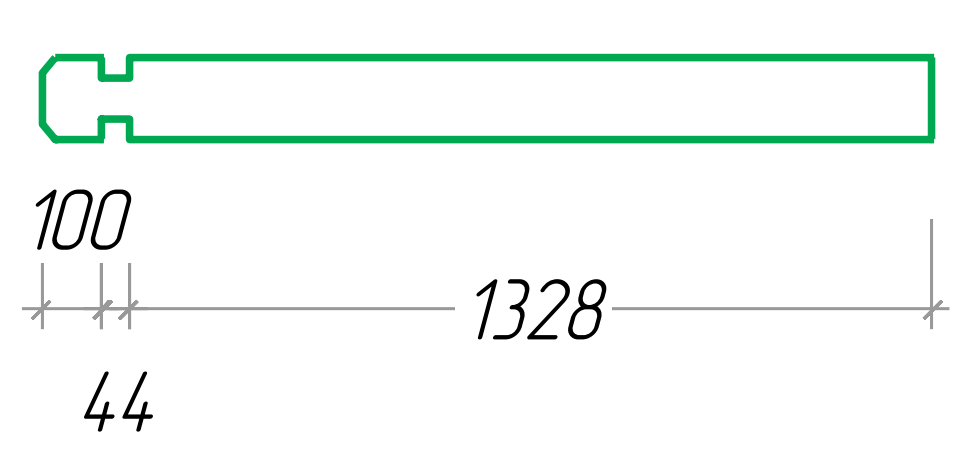
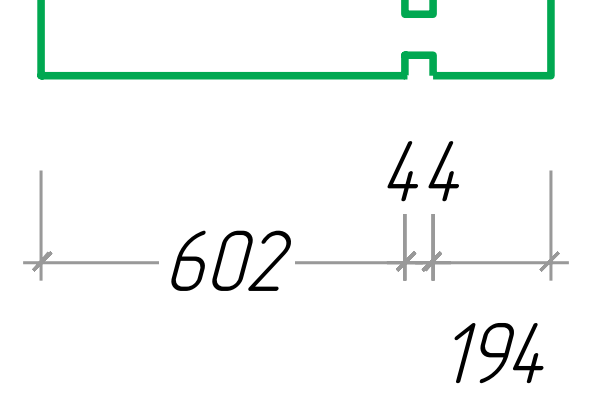
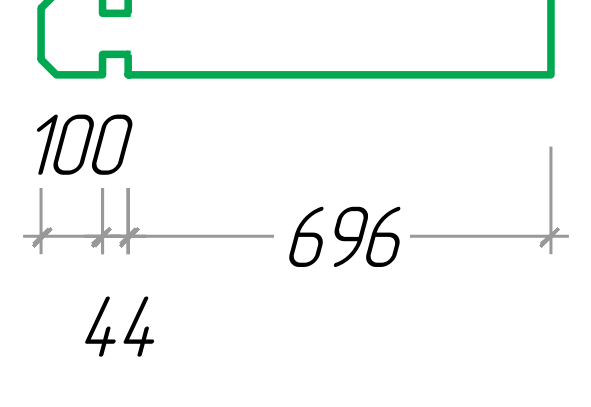
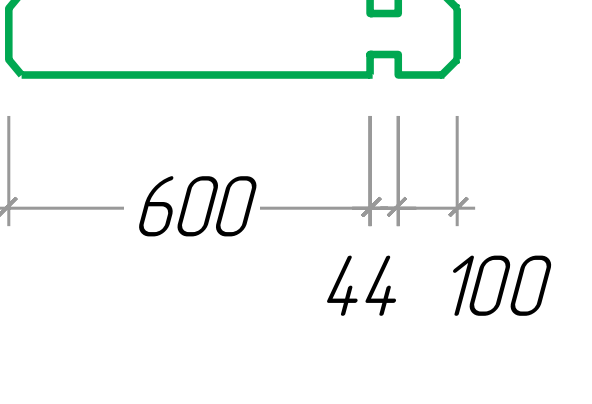





№		Nr.	Profile (mm)	Length (mm)
1		1	44x54,1	3246mm
2		1	44x67,5	4129mm
3		1	44x67,5	3165mm
4		1	44x67,5	2414mm
5		1	44x67,5	2090mm
6		1	44x67,5	2090mm
7		1	44x67,5	1588mm
8		1	44x67,5	1472mm
9		1	44x67,5	266mm
10		1	44x67,5	244mm
11		1	44x79	3224mm
12		1	44x79	3122mm
13		1	44x79	1914mm





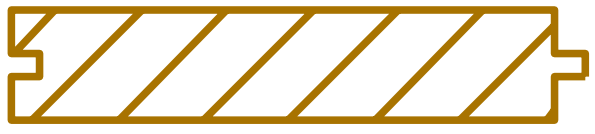
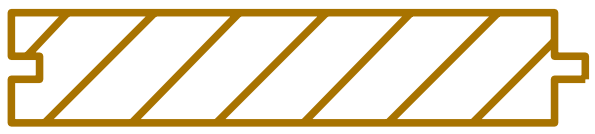

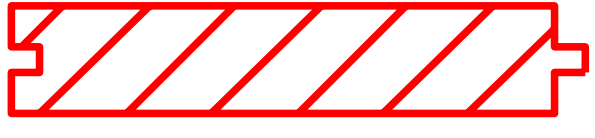
Nº		Nr.	Profile (mm)	Lenght (mm)
14		1	44x133	3224mm
15		1	44x133	3122mm
16		1	44x133	1914mm
17		3	44x135	5000mm
19		1	44x135	4952mm
20		3	44x135	4878mm
21		1	44x135	4830mm
22		8	44x135	4758mm
26		7+1	44x135	4636mm
27		3	44x135	4129mm
35		8	44x135	3514mm
36		1	44x135	3446mm
37		8	44x135	3386mm

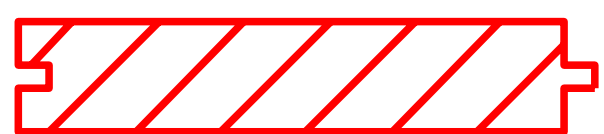
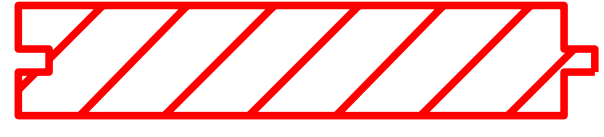
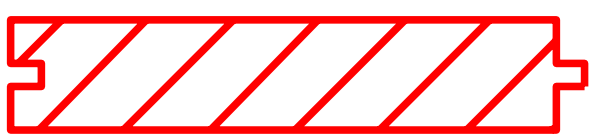

Nº		Nr.	Profile (mm)	Lenght (mm)
38		35	44x135	3246mm
39		1	44x135	3246mm
40		1	44x135	3224mm
41		1	44x135	3224mm
44		6	44x135	3165mm
45		8+1	44x135	3124mm
46		1	44x135	3122mm
47		1	44x135	3122mm
48		8	44x135	2984mm
52		7	44x135	2425mm
53		1	44x135	2425mm
54		3	44x135	2414mm
56		1	44x135	2158mm





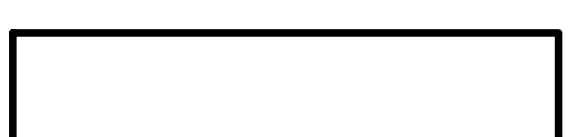
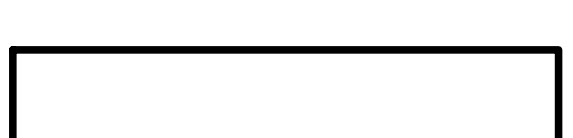
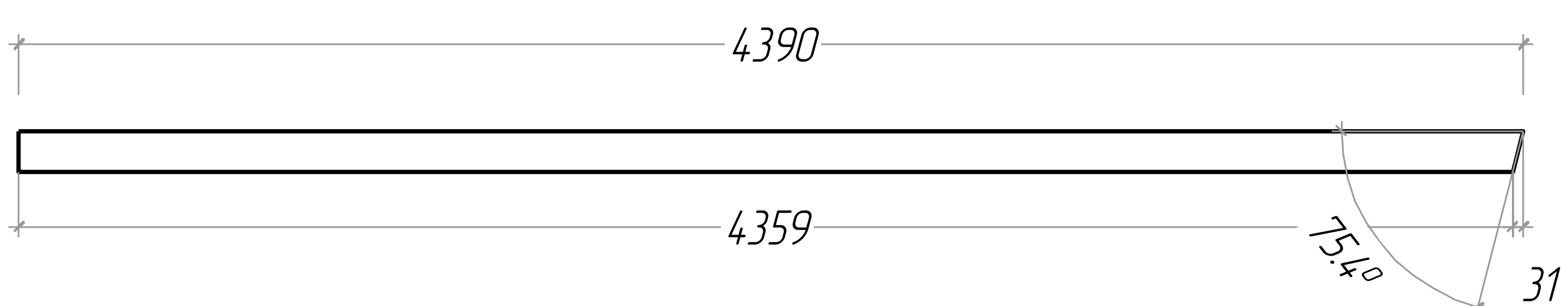
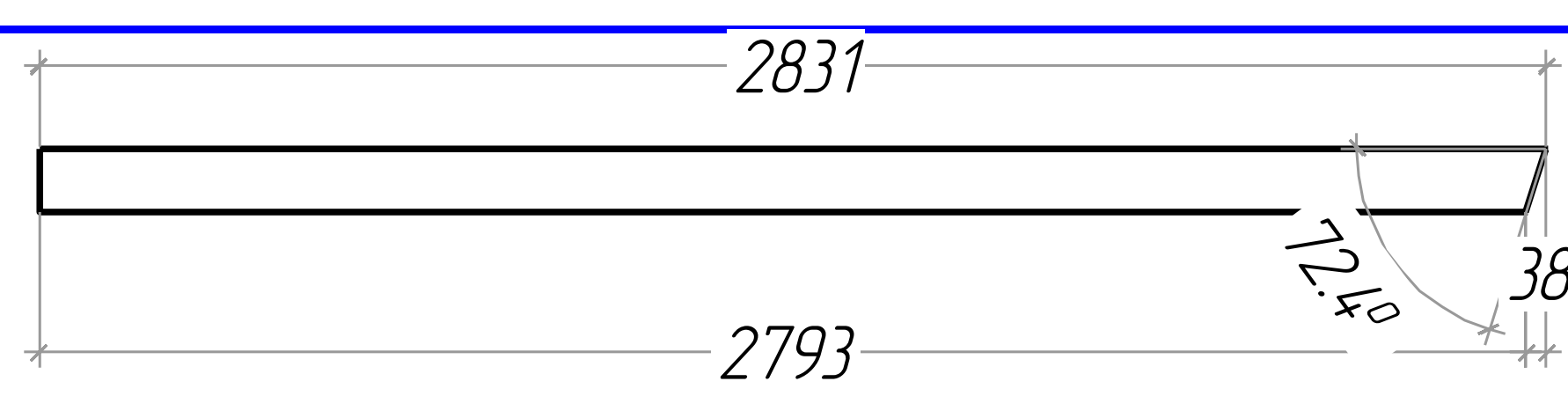
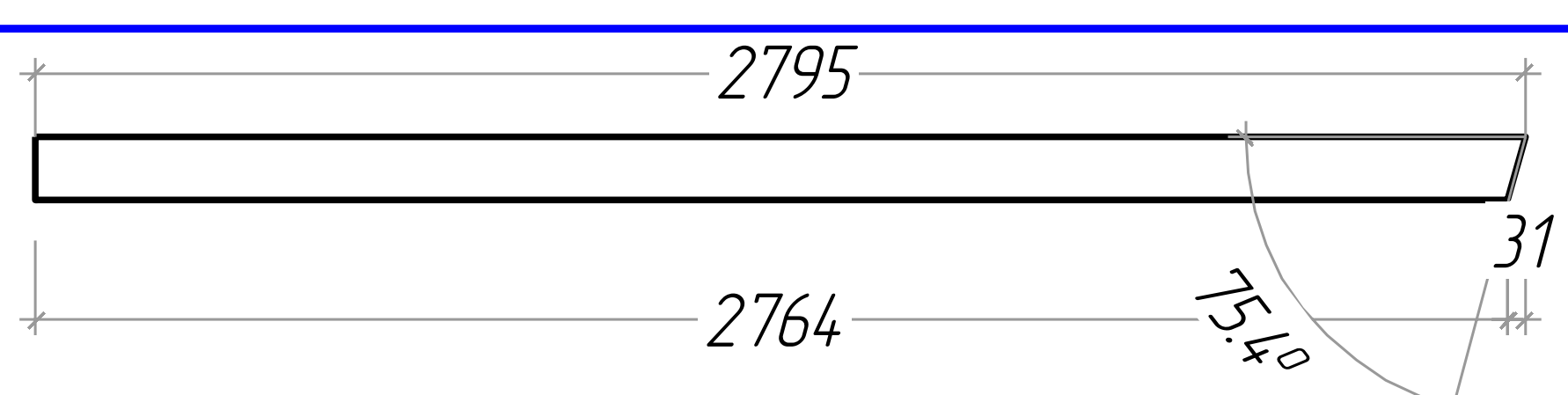

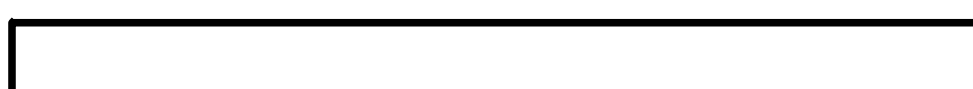
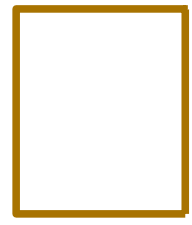

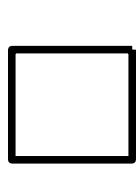
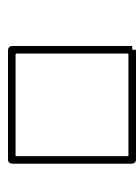
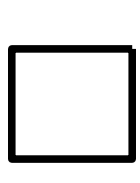
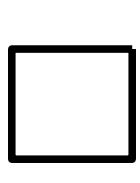
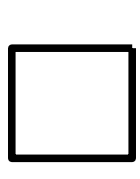
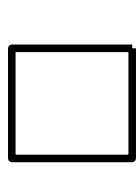
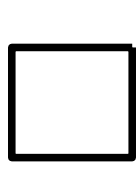
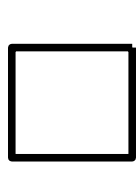
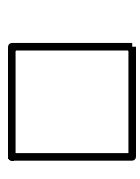
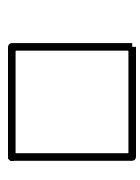
Nº		Nr.	Profile (mm)	Lenght (mm)
57		4	44x135	2158mm
58		6	44x135	2090mm
59		6	44x135	2090mm
62		1	44x135	1914mm
63		1	44x135	1914mm
64		8	44x135	1722mm
65		3	44x135	1665mm
66		15	44x135	1588mm
67		8	44x135	1478mm
68		14	44x135	1472mm
71		8	44x135	840mm
72		8	44x135	840mm
73		19	44x135	744mm

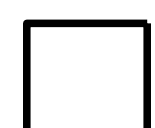
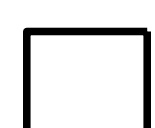
Nº		Nr.	Profile (mm)	Length (mm)
74		28	44x135	669mm
75		8	44x135	667mm
76		8	44x135	543mm
77		8	44x135	523mm
78		8	44x135	350mm
79		8	44x135	344mm
80		14	44x135	266mm
81		32	44x135	244mm
82	<i>Roof beam. Dachbalken. Panne</i> 	3	44x140	3346mm
83	<i>Roof beam. Dachbalken. Panne</i> 	3	44x140	3244mm
84	<i>Roof beam. Dachbalken. Panne</i> 	1	44x140	3224mm
85	<i>Roof beam. Dachbalken. Panne</i> 	1	44x140	3122mm
86	<i>Roof beam. Dachbalken. Panne</i> 	3	44x140	2158mm

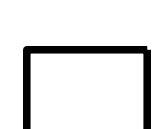
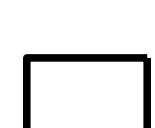
Nº		Nr.	Profile (mm)	Lenght (mm)
87	Roof beam. Dachbalken. Panne 	1	44x140	1914mm
88	Foundation Fundament Solive 	20	44x68	4702mm
89	Foundation Fundament Solive 	1	44x68	4602mm
90	Foundation Fundament Solive 	1	44x68	4531mm
91	Foundation Fundament Solive 	1	44x68	3036mm
92	Foundation Fundament Solive 	1	44x68	3019mm
93	Foundation Fundament Solive 	7	44x68	1543mm
94	Foundation Fundament Solive 	2	44x68	1499mm
95	Roof boards. Dachbretter Volige 	30+1	20x115	4357mm
96	Roof boards. Dachbretter Volige 	72	20x115	2800mm
97	Roof boards. Dachbretter Volige 	42	20x115	2764mm
98	Floor boards Fu ssboden Lame de plancher 	16+1	20x115	4490mm
99	Floor boards Fu ssboden Lame de plancher 	13	20x115	4466mm

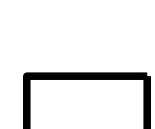
Nº	Dijon 44 7.6x6.3	Nr.	Profile (mm)	Lenght (mm)
100	Floor boards Fu ssboden Lame de plancher 	16+1	20x115	2978mm
101	Floor boards Fu ssboden Lame de plancher 	39	20x115	2954mm
102	Floor boards Fu ssboden Lame de plancher 	12	20x115	2552mm
103	Floor boards Fu ssboden Lame de plancher 	12	20x115	1866mm
104	Roofing felt fillet Giebelabschlussbrett Latte de finition couverture 	1	20x58	4382mm
105	Roofing felt fillet Giebelabschlussbrett Latte de finition couverture 	2	20x58	2824mm
106	Roofing felt fillet Giebelabschlussbrett Latte de finition couverture 	1	20x58	2788mm
107	Roofing felt fillet Giebelabschlussbrett Latte de finition couverture 	1	20x58	1594mm
108	Roof side boards Traufenbrett Planche de rive 	2	18x90	3446mm
109	Roof side boards Traufenbrett Planche de rive 	4	18x90	2407mm
110	Fascia board Giebelblende Planch de rive facade 	1	20x120	4390mm
111	Fascia board Giebelblende Planch de rive facade 	2	20x120	2831mm
112	Fascia board Giebelblende Planch de rive facade 	1	20x120	2795mm

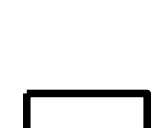
Nº	Dijon 44 7.6x6.3		Nr.	Profile (mm)	Lenght (mm)
113	Fascia board Giebelblende Planch de rive facade		1	20x120	1596mm
114	Roof edge reinforcement Traufenleiste Tasseau		2	28x34	3446mm
115	Roof edge reinforcement Traufenleiste Tasseau		4	28x34	2407mm
116	Floor edge trim Fu bleisten Plinthe plancher		4	18x20	2958mm
117	Floor edge trim Fu bleisten Plinthe plancher		2	18x20	2556mm
118	Floor edge trim Fu bleisten Plinthe plancher		1	18x20	2420mm
119	Floor edge trim Fu bleisten Plinthe plancher		1	18x20	2248mm
120	Floor edge trim Fu bleisten Plinthe plancher		1	18x20	1903mm
121	Floor edge trim Fu bleisten Plinthe plancher		2	18x20	1870mm
122	Floor edge trim Fu bleisten Plinthe plancher		2	18x20	1499mm
123	Floor edge trim Fu bleisten Plinthe plancher		5	18x20	1300mm
124	Floor edge trim Fu bleisten Plinthe plancher		1	18x20	1285mm
125	Floor edge trim Fu bleisten Plinthe plancher		1	18x20	1275mm

Nº	<i>Dijon 44 7.6x6.3</i>		Nr.	Profile (mm)	Lenght (mm)
126	Floor edge trim Fu bleisten Plinthe plancher		2	18x20	618mm
127	Floor edge trim Fu bleisten Plinthe plancher		1	18x20	559mm
128	Floor edge trim Fu bleisten Plinthe plancher		2	18x20	482mm
129	Floor edge trim Fu bleisten Plinthe plancher		2	18x20	472mm
130	Floor edge trim Fu bleisten Plinthe plancher		14	18x20	118mm
131	Floor edge trim Fu bleisten Plinthe plancher		1	18x20	91mm
132	Floor edge trim Fu bleisten Plinthe plancher		10	18x20	80mm
133	Floor edge trim Fu bleisten Plinthe plancher		1	18x20	69mm
134	Floor edge trim Fu bleisten Plinthe plancher		1	18x20	57mm
135	Floor edge trim Fu bleisten Plinthe plancher		1	18x20	47mm
136	Diamond Raute Diamant		2	18x120	120mm
137	Storm protection		4	28x34	1900mm
	Window Fenetre Fenster	<i>1080x1390 mm</i>	1 6	Window Fenetre Fenster	<i>1080x900 mm</i>

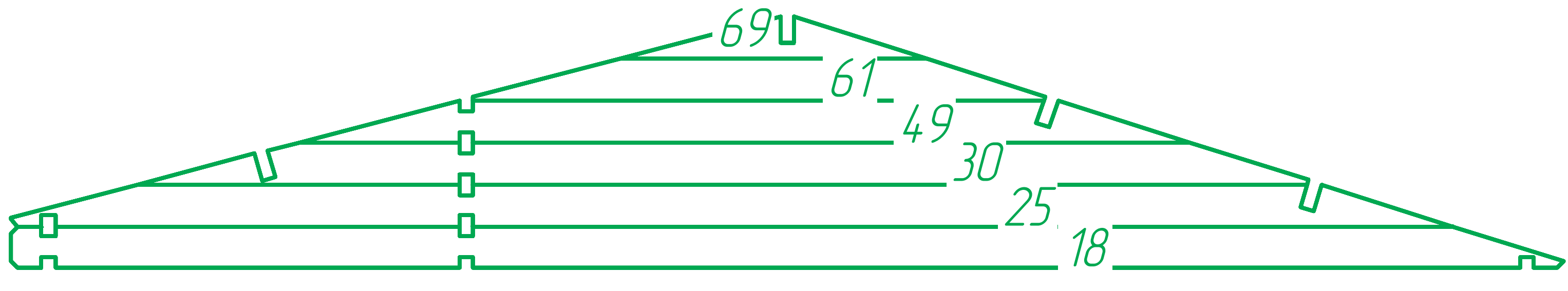
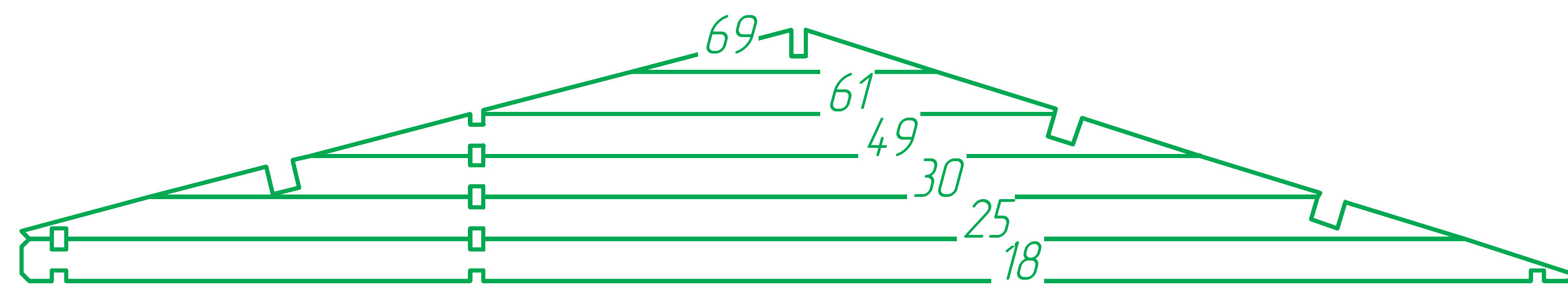
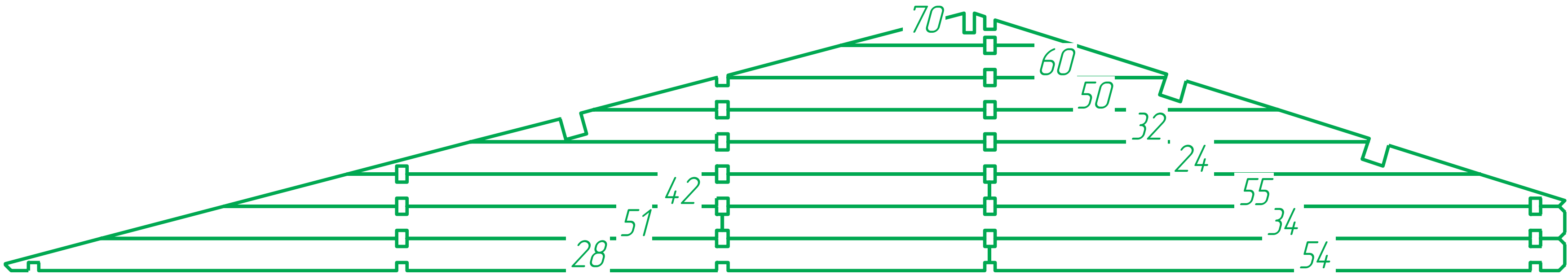
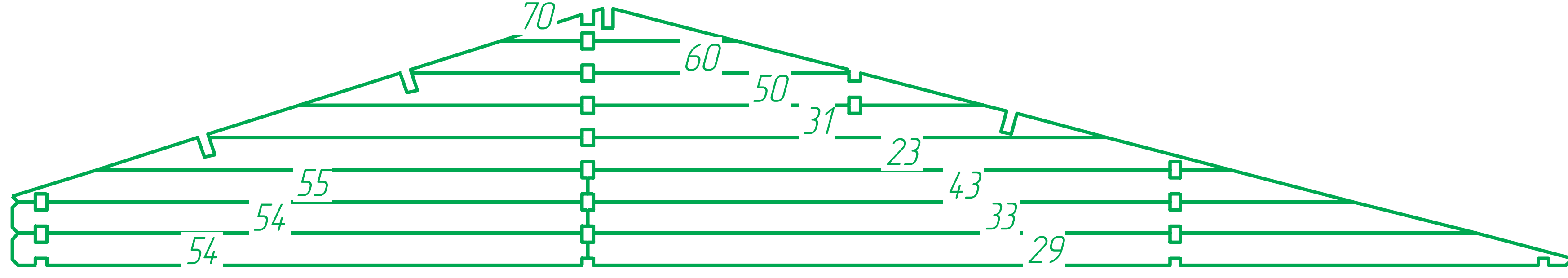
Nº				
	<p>Door Tur La porte</p>	4		
W1		1		
W2		1		
W3		1		
W4		1		

W-2

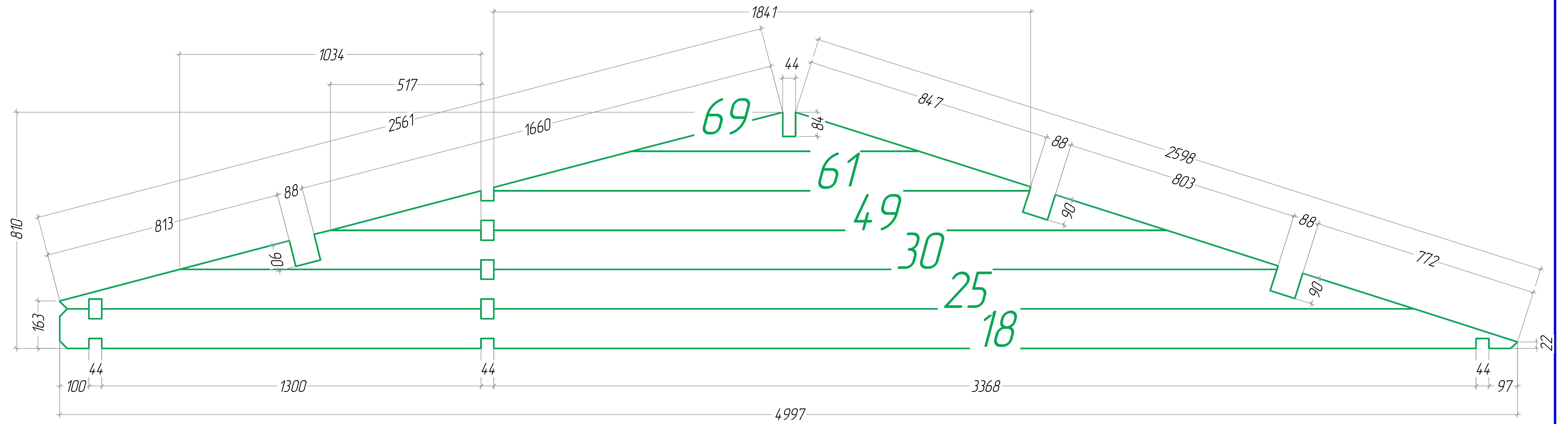

W-3

Dijon 44 7.6x6.3

