

Přístavba 34

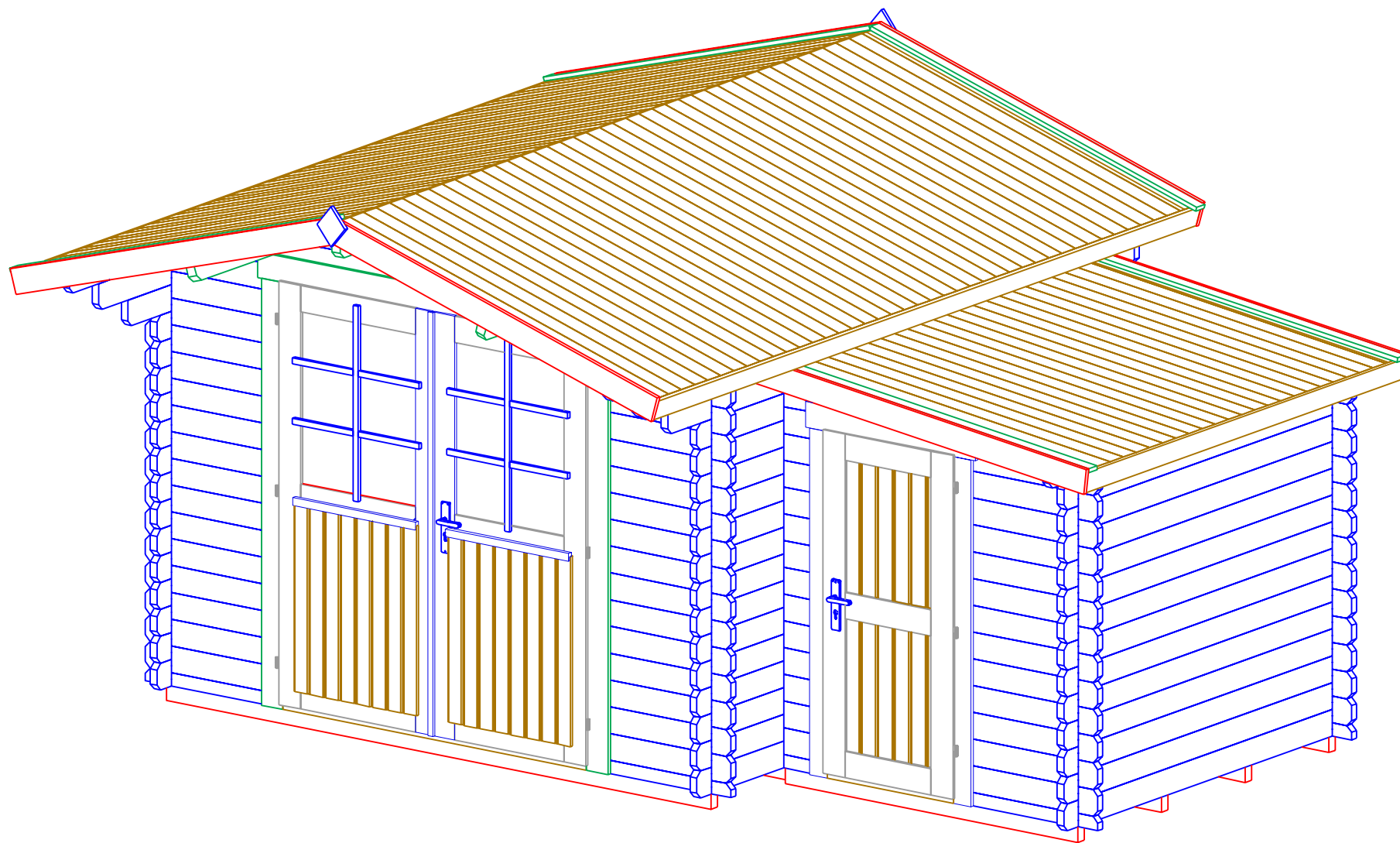

Přístavba 34

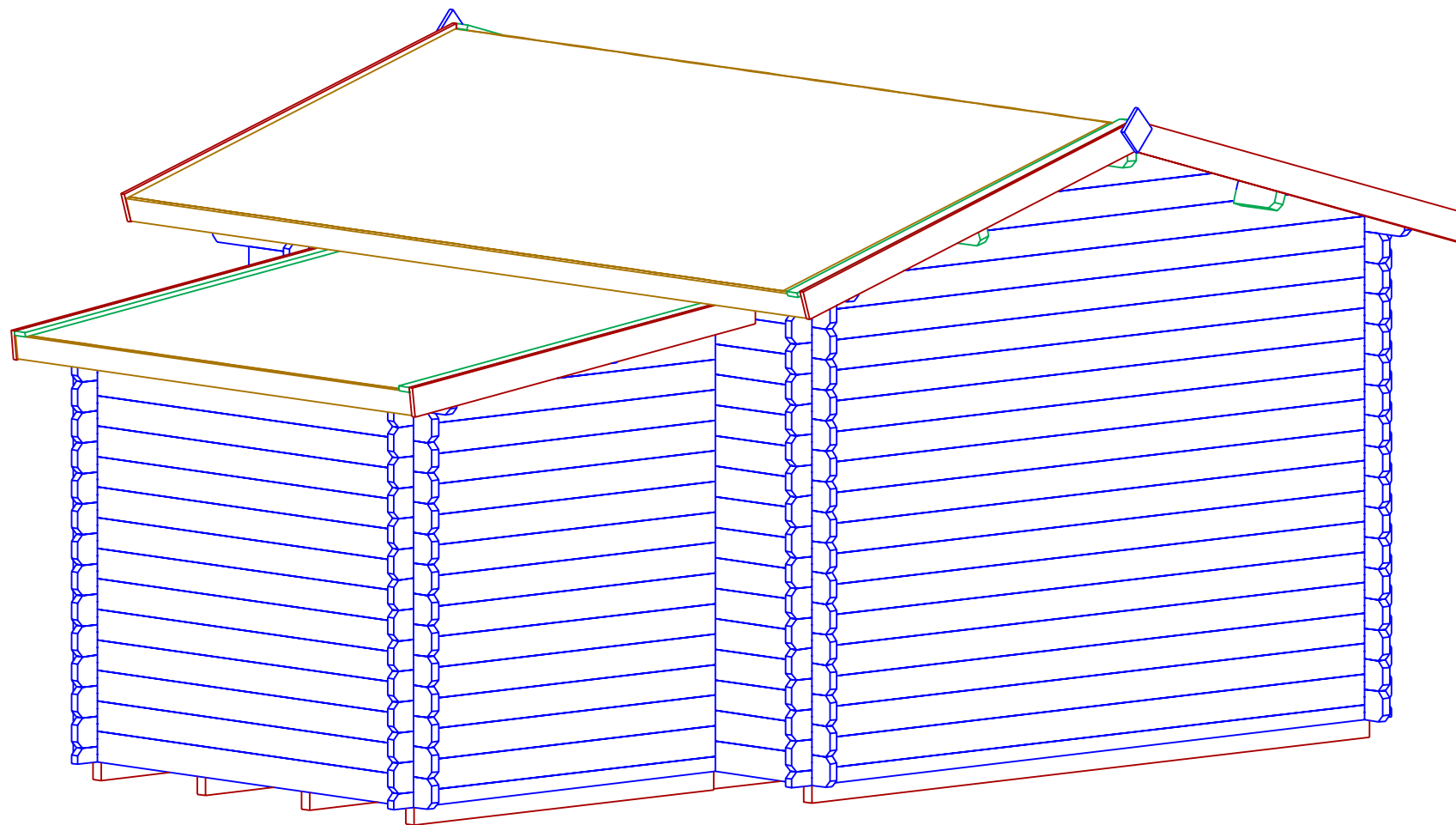

Přístavba 34

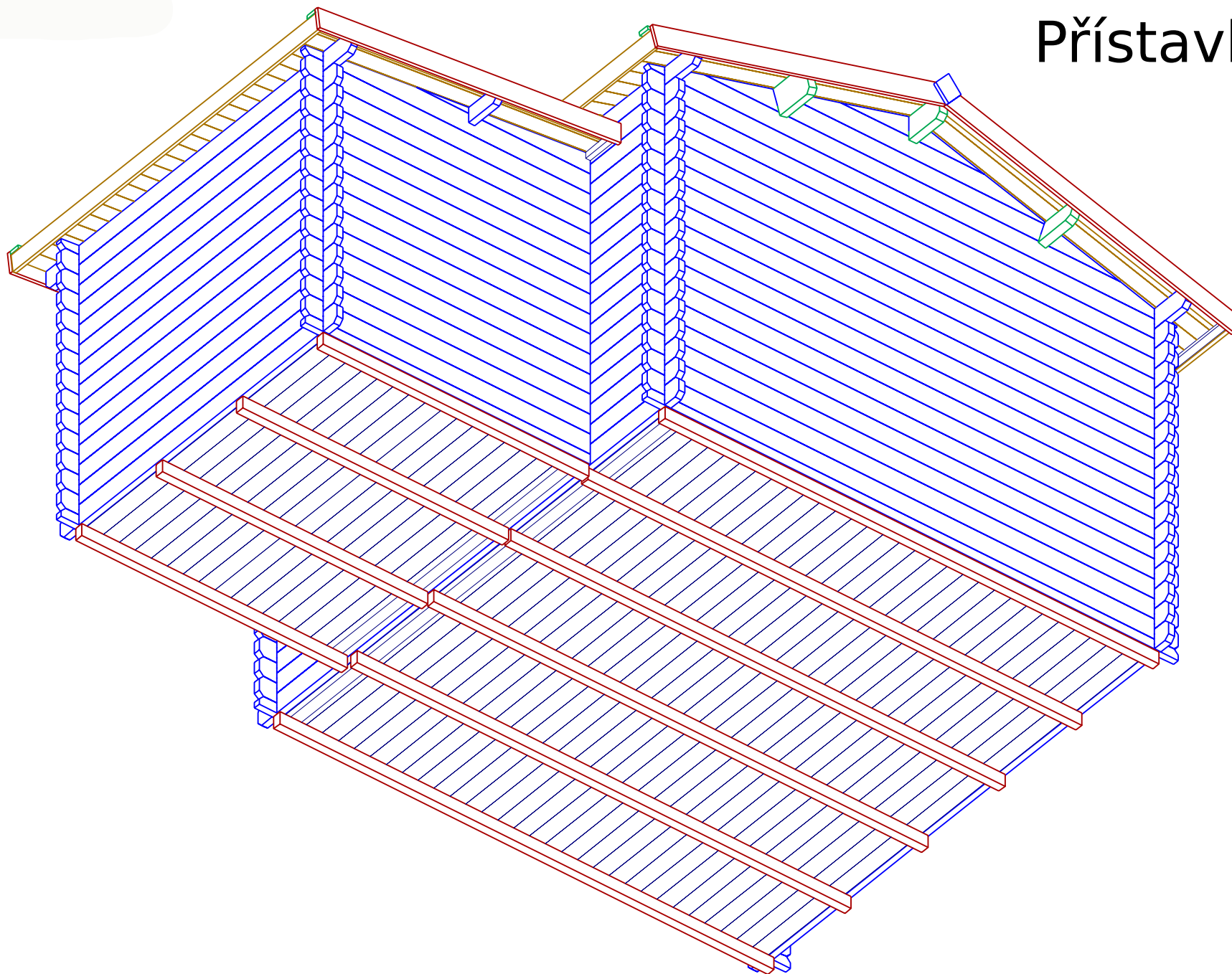

Přístavba 34



x

Přístavba 34

Grundriss

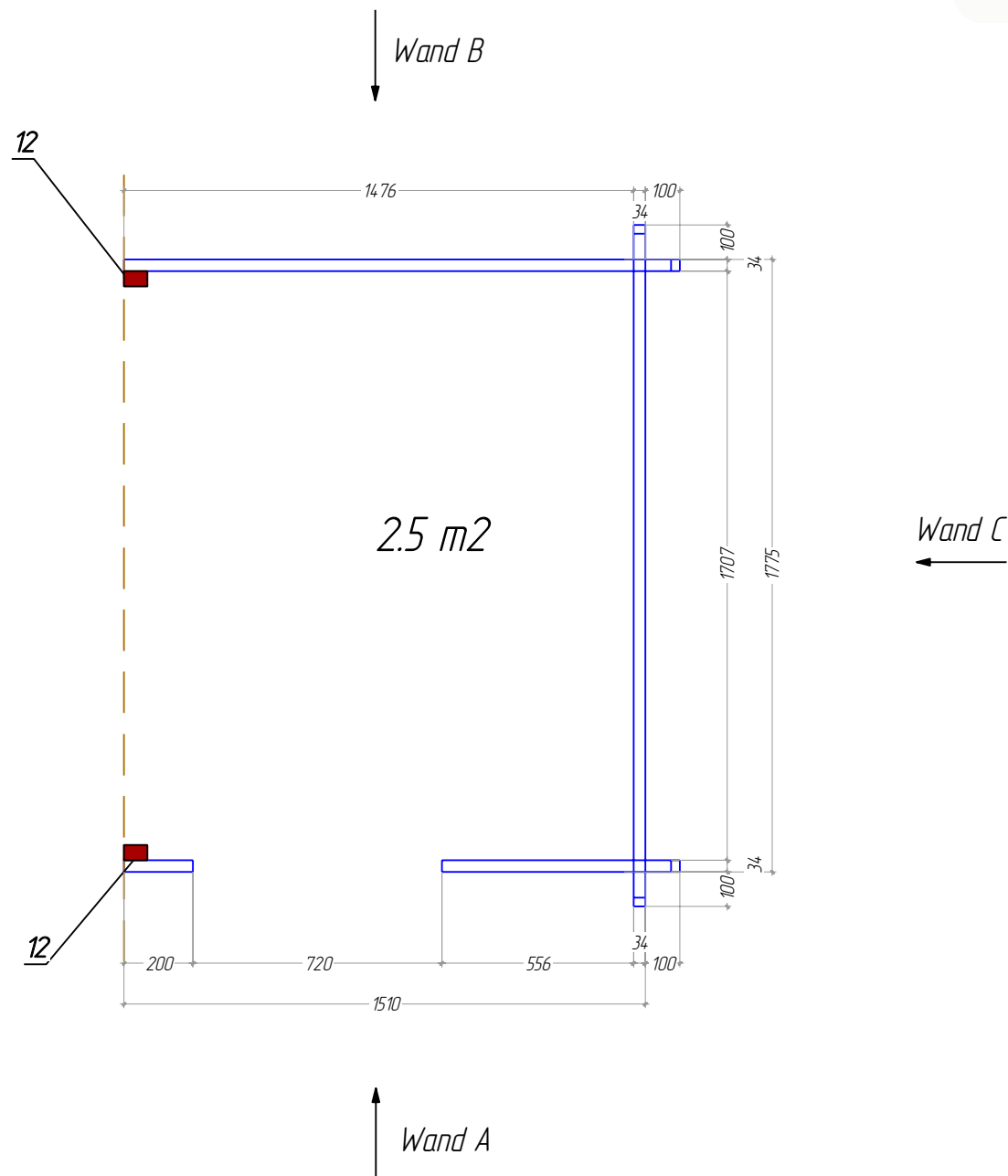

Přístavba 34

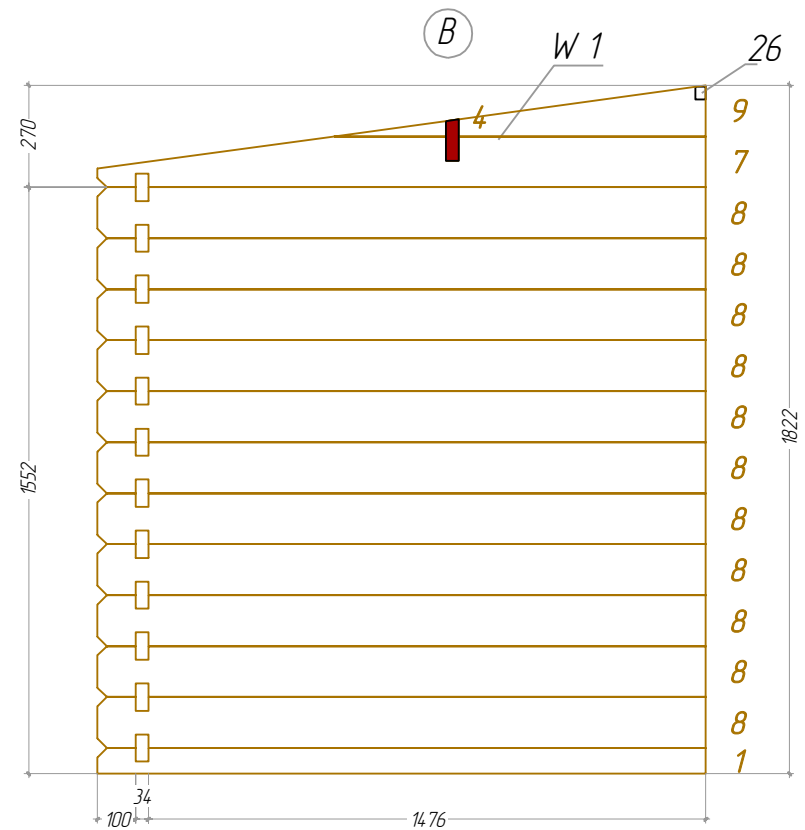
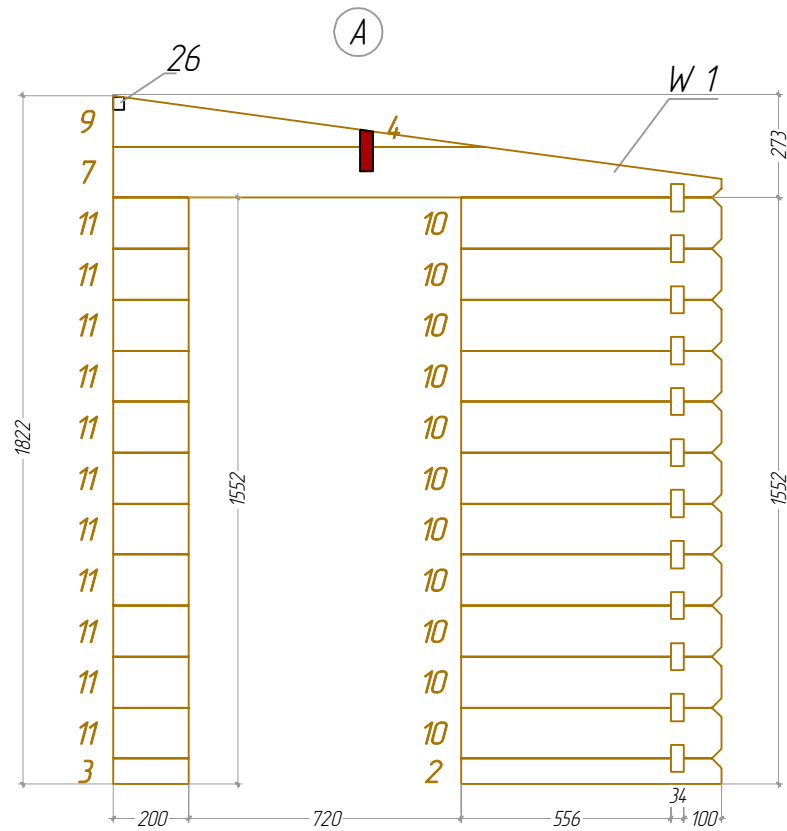

Přístavba 34

ℓ

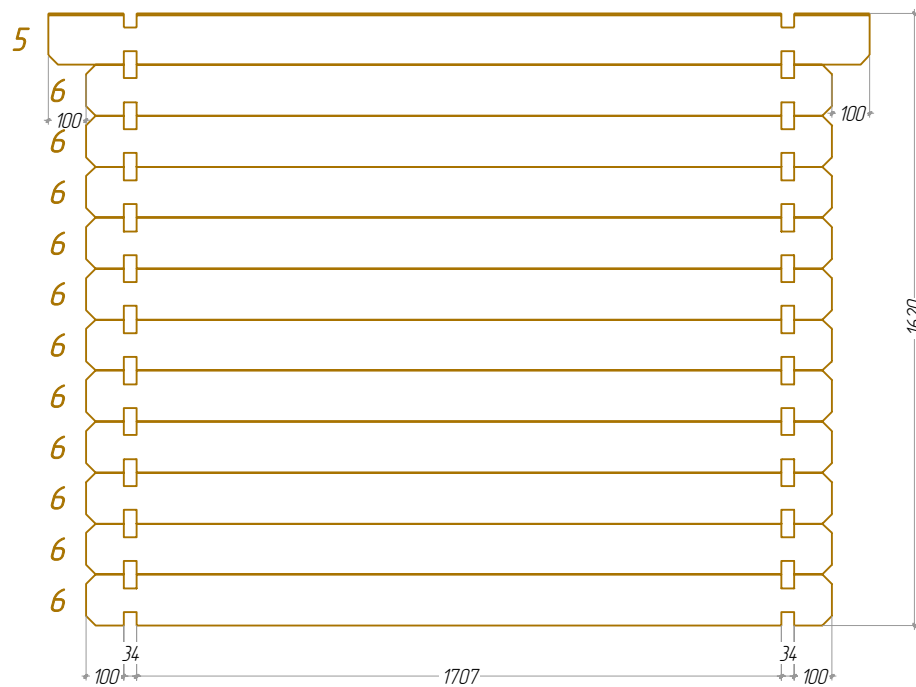

Přístavba 34

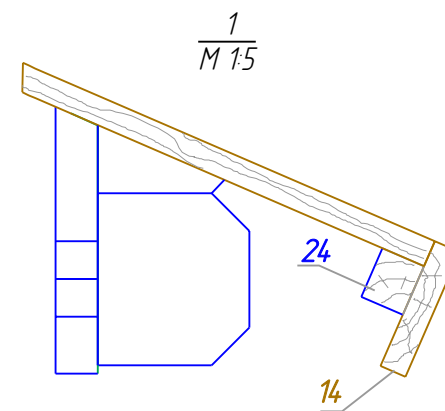
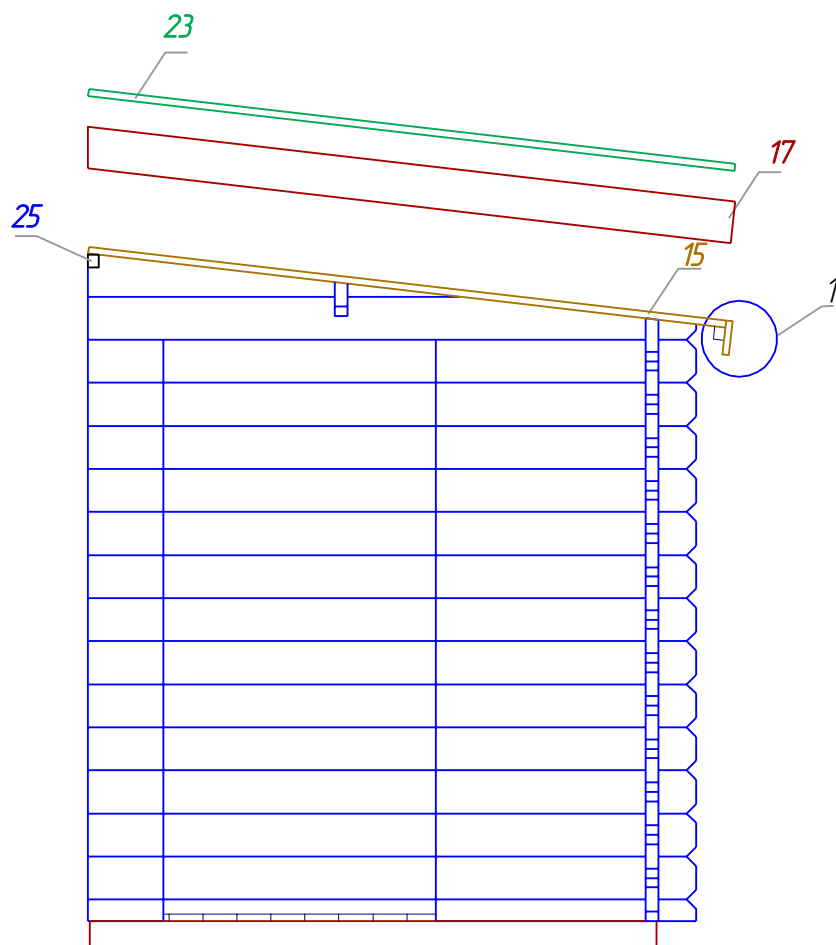

Přístavba 34

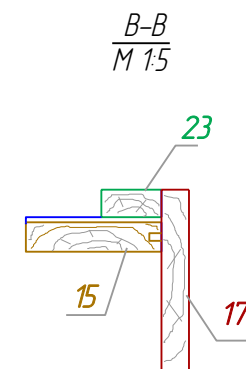
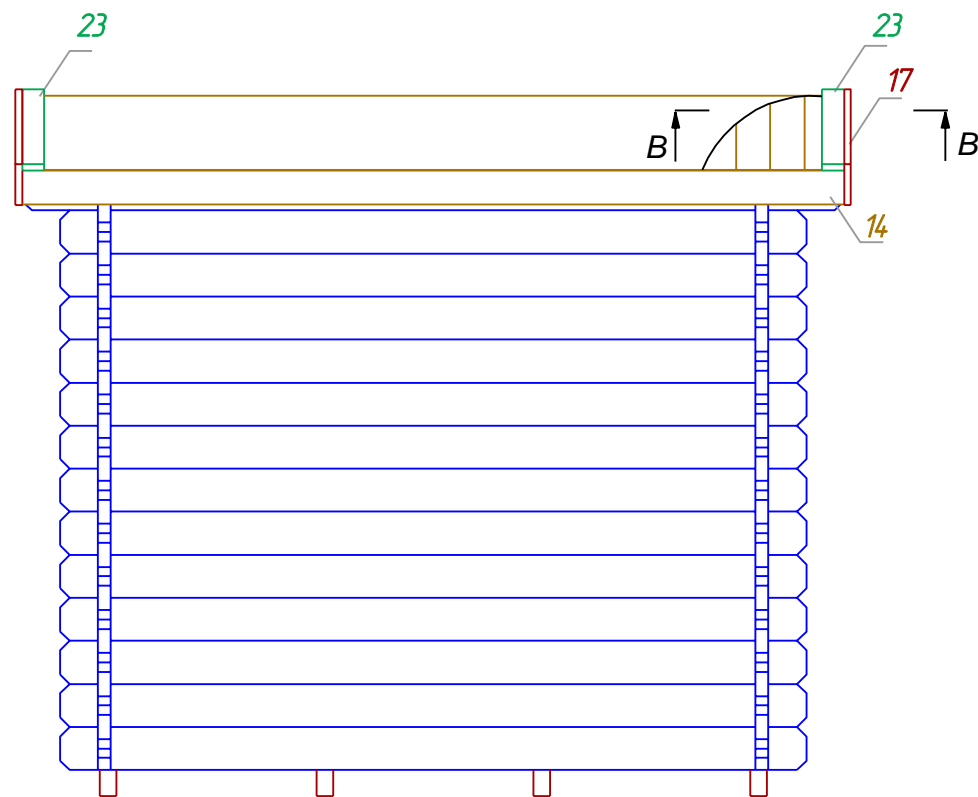





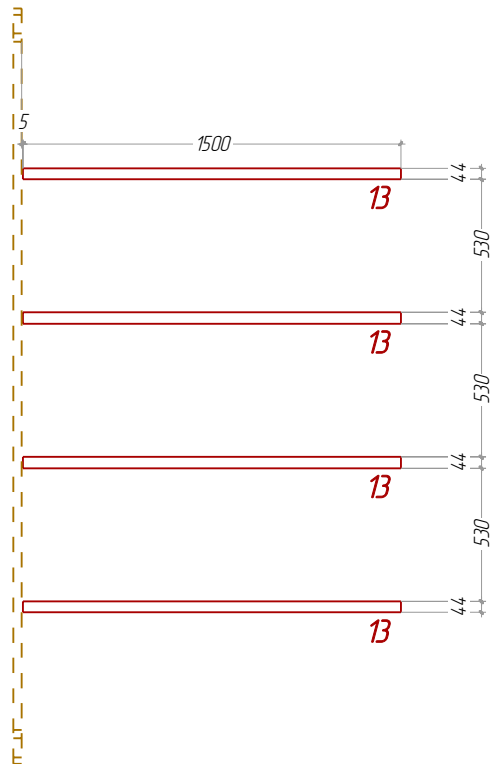

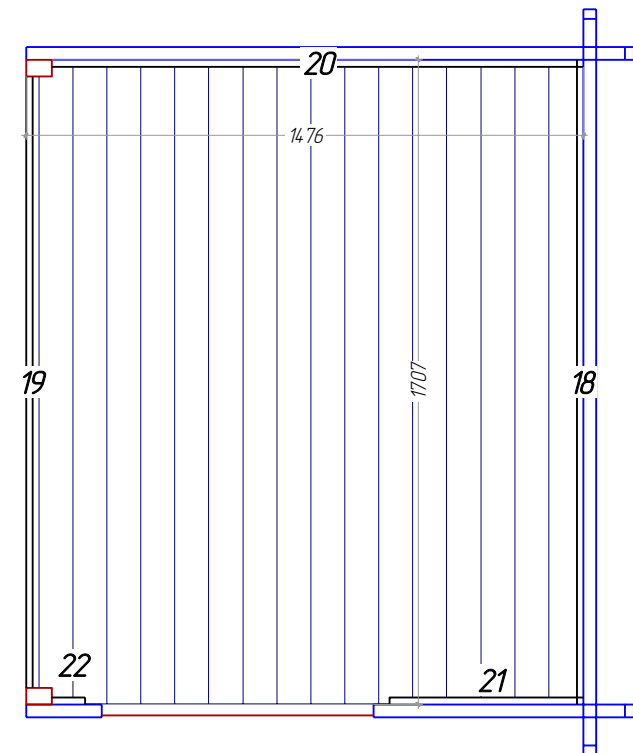

Přístavba 34

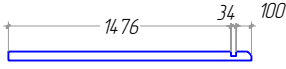
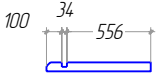

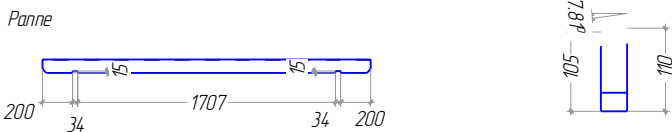
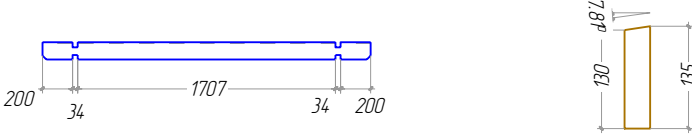
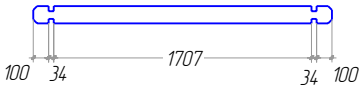
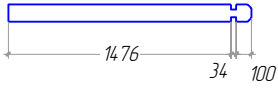
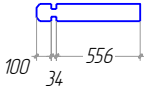



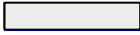

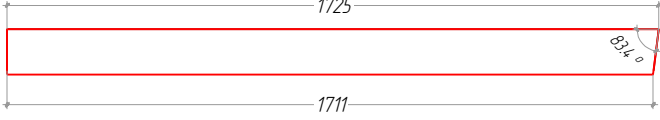

Fundament balken



Fussboden

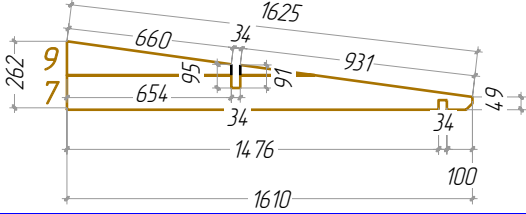

N ^o	Přístavba 34	St.	Schnittl	Länge
1		1	34x68	1610mm
2		1	34x68	690mm
3		1	34x68	200mm
4	<p data-bbox="236 674 467 696"><i>Roof beam. Dachbalken. Panne</i></p> 	1	34x110	2175mm
5		1	34x135	2175mm
6		11+1	34x135	1975mm
8		11	34x135	1610mm
10		11	34x135	690mm
11		11	34x135	200mm
12		2	44x68	1760mm
13	<p data-bbox="268 1720 355 1787"><i>Foundation Fundament Solvie</i></p> 	4	44x68	1500mm
14	<p data-bbox="268 1854 395 1933"><i>Roof side boards Traufenbrett Planche de rive</i></p> 	1	18x95	2175mm
15	<p data-bbox="268 2007 371 2074"><i>Roof boards. Dachbretter Volige</i></p> 	19+1	20x115	1698mm

N ^o	Přístavba 34	St.	Schnittl	Lange
16	Floor boards Fu ssboden Lame de plancher 	13+1	20x115	1703mm
17	Fascia board Giebelblende Planch de rive facade 	2	18x120	1725mm
18	Floor edge trim Fu bleisten Plinthe plancher 	1	18x20	1707mm
19	Floor edge trim Fu bleisten Plinthe plancher 	1	18x20	1619mm
20	Floor edge trim Fu bleisten Plinthe plancher 	1	18x20	1408mm
21	Floor edge trim Fu bleisten Plinthe plancher 	1	18x20	513mm
22	Floor edge trim Fu bleisten Plinthe plancher 	1	18x20	89mm
23	Roof edge reinforcement Traufleisten Tasseau 	2	20x58	1723mm
24	Roofing felt fillet Giebelabschlussbrett Latte de finition couverture 	1	28x34	2175mm
25	Roofing felt fillet Giebelabschlussbrett Latte de finition couverture 	1	28x34	1705mm
26	Roofing felt fillet Giebelabschlussbrett Latte de finition couverture 	2	28x34	200mm
W1		2		
	Door Tur La porte 1552x 710MM	1		