

Silvan 44 4.5x6

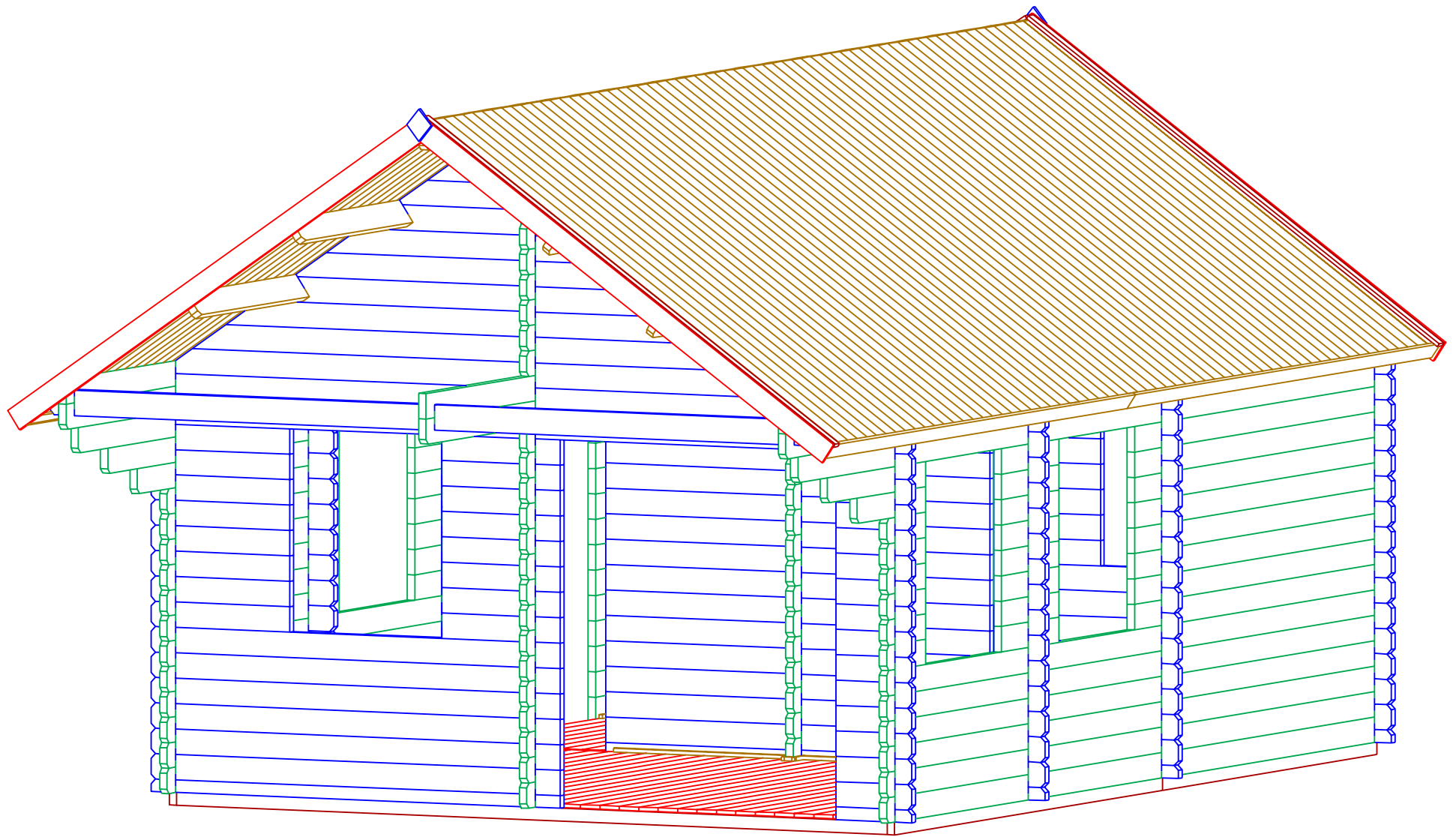

Silvan 44 4.5x6

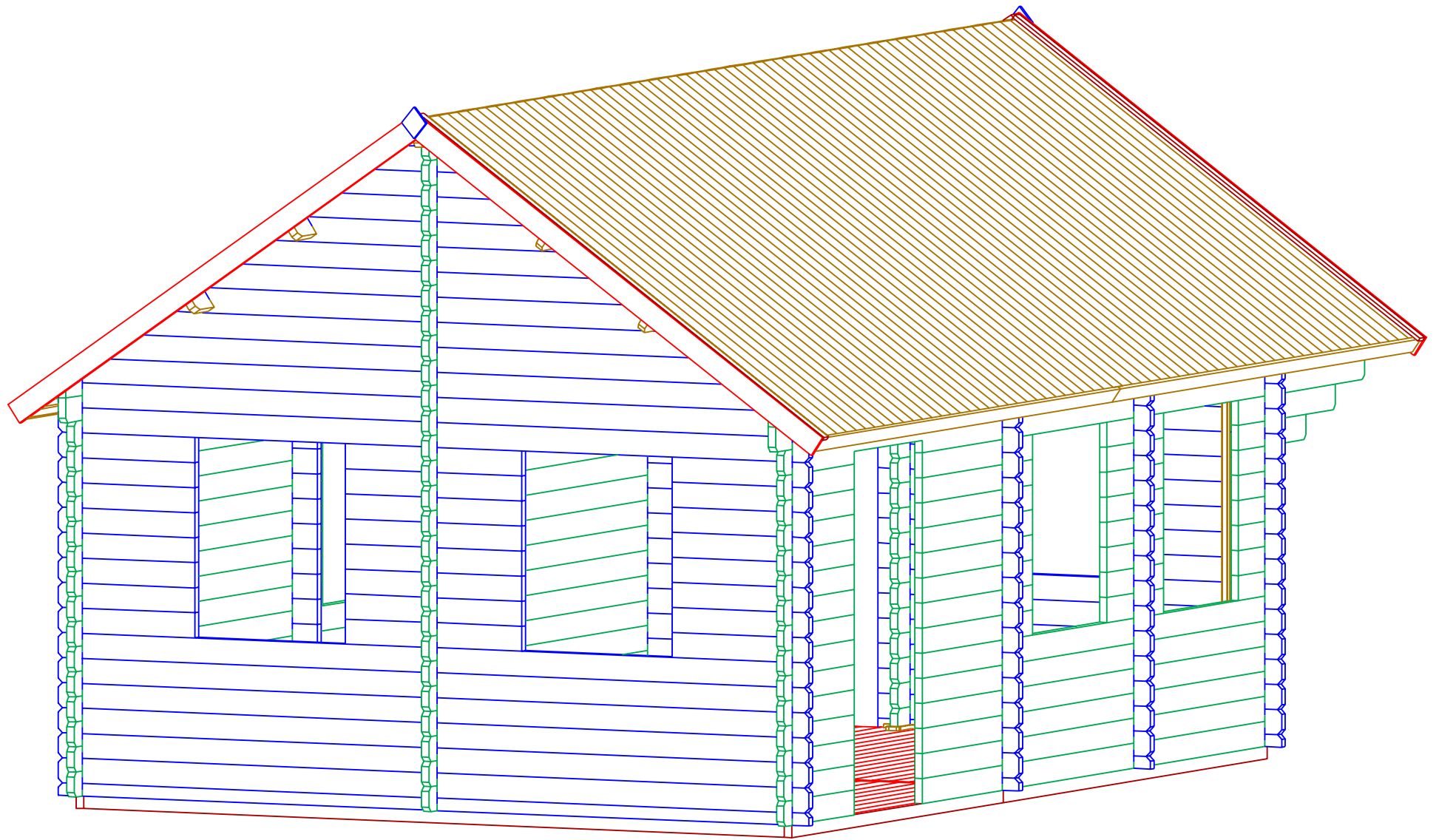

Silvan 44 4.5x6

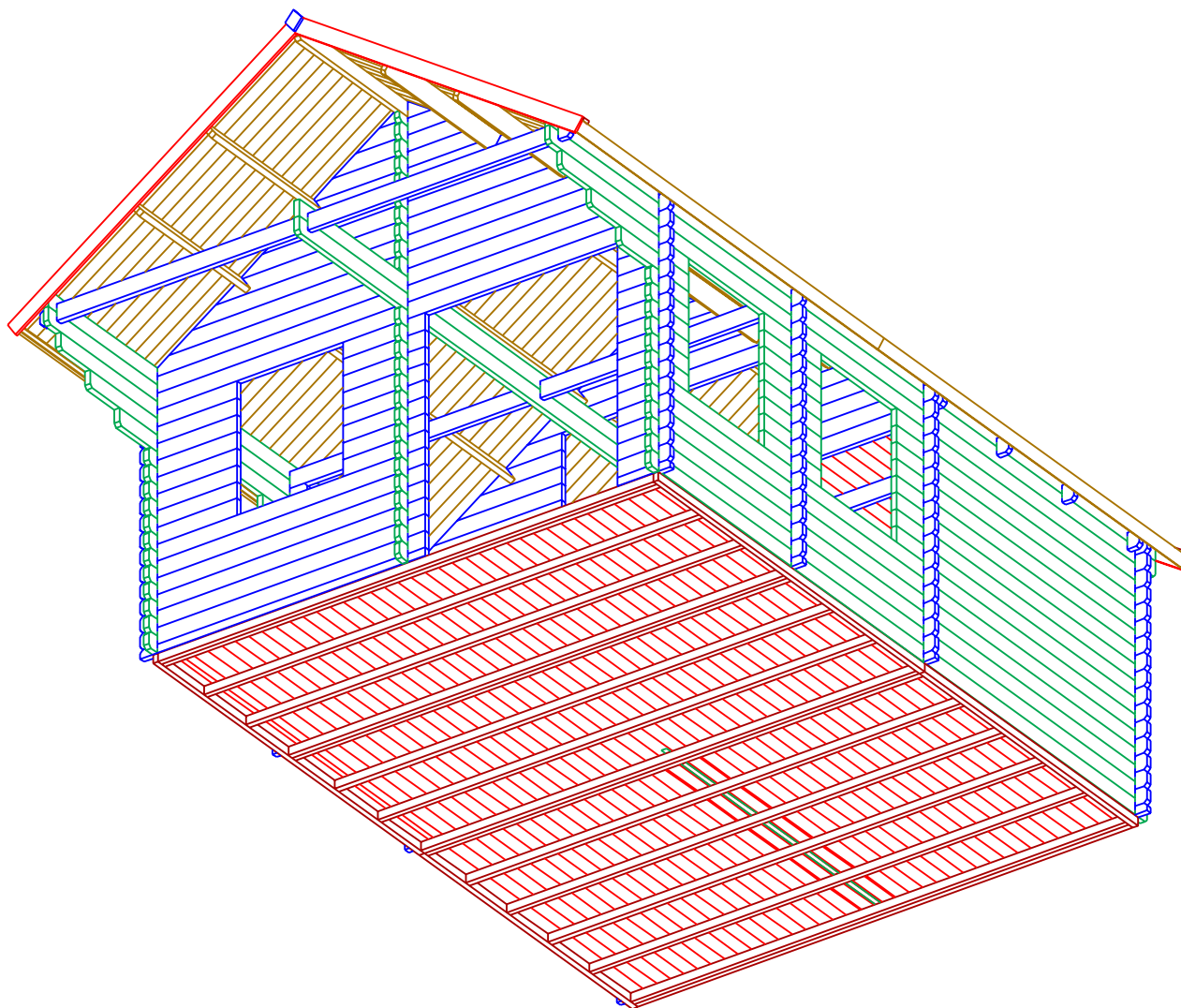

Silvan 44 4.5x6  
Plan

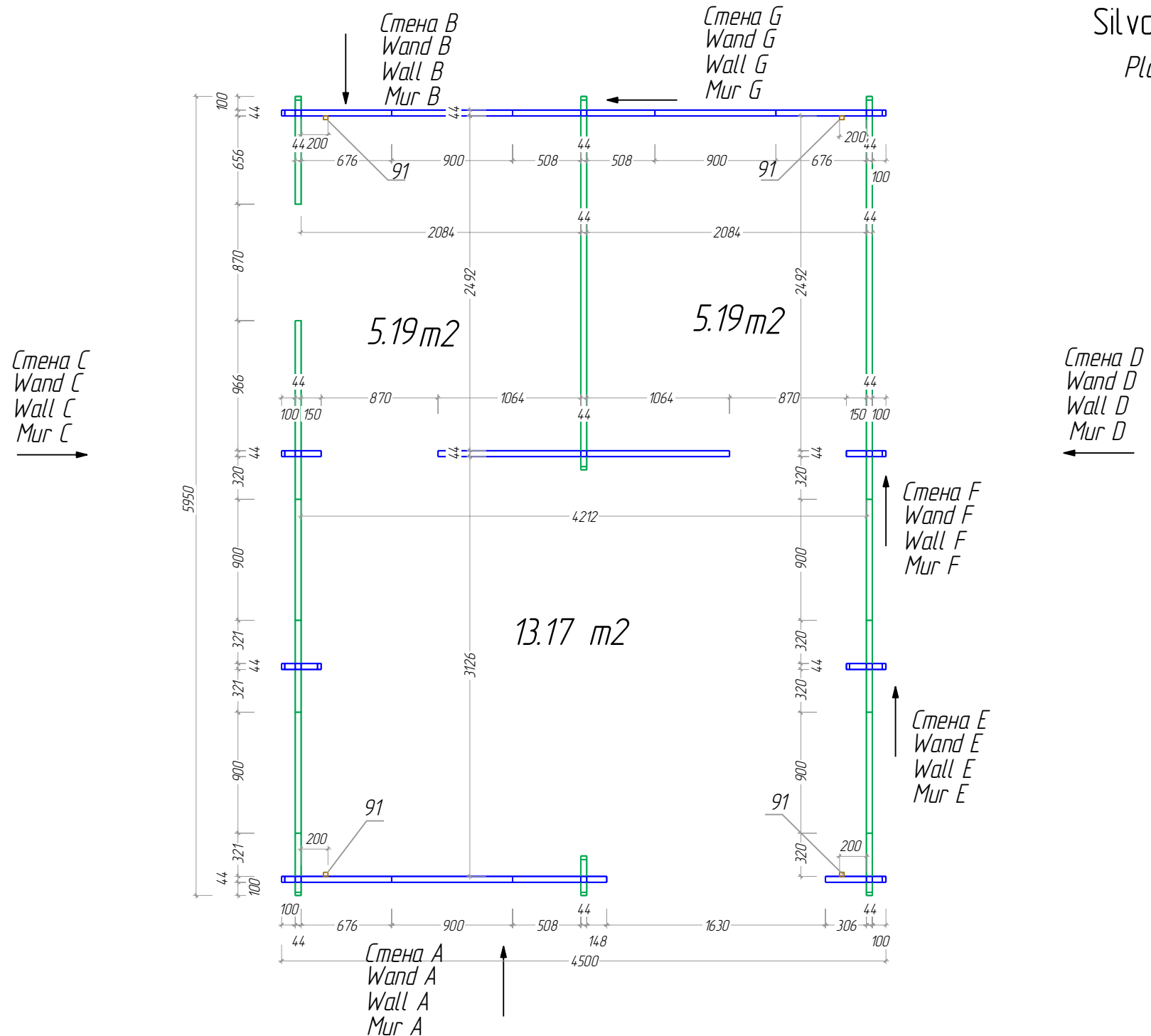

# Silvan 44 4.5x6

(A)

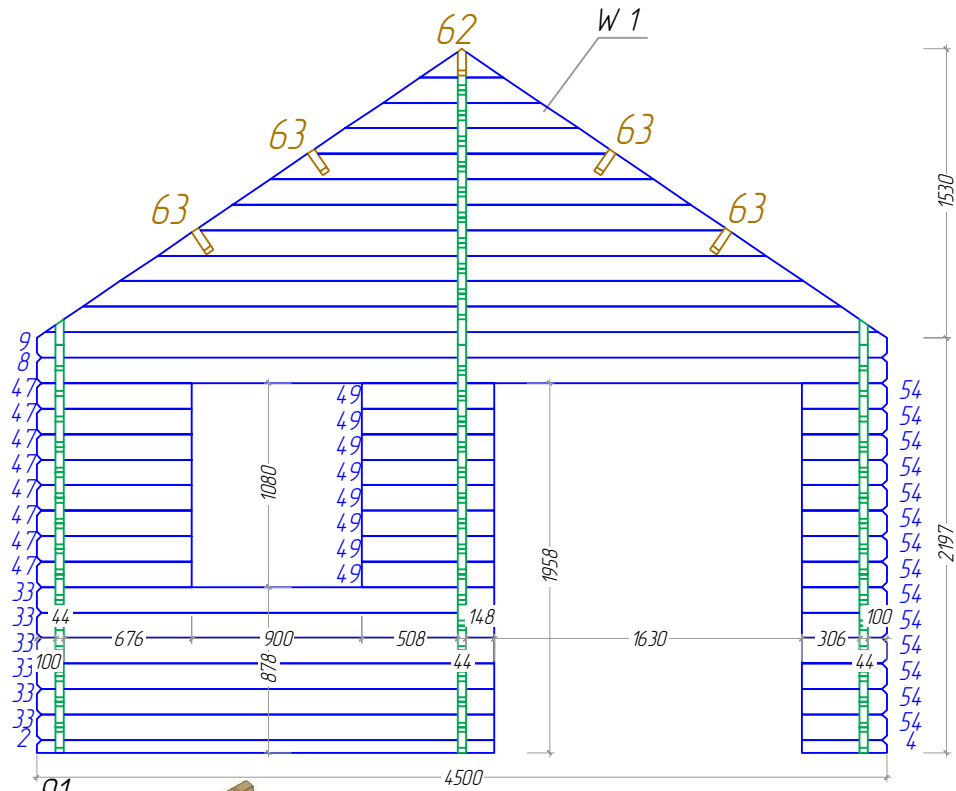

(B)

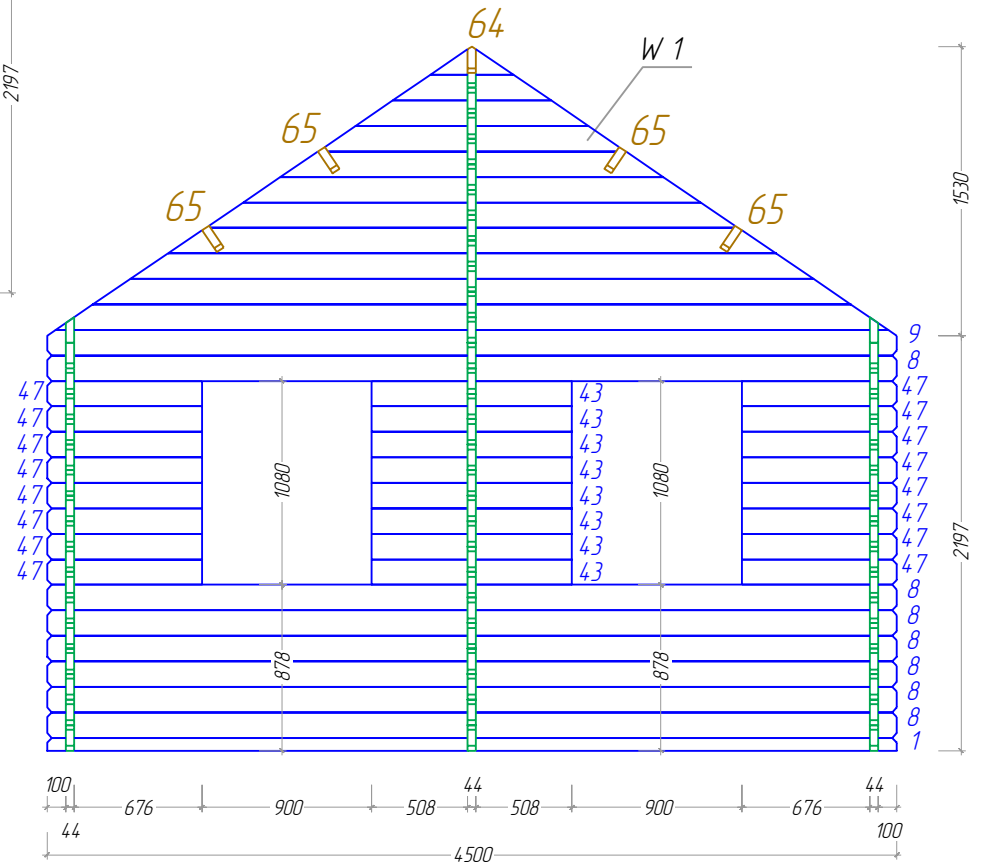

Silvan 44 4.5x6

C

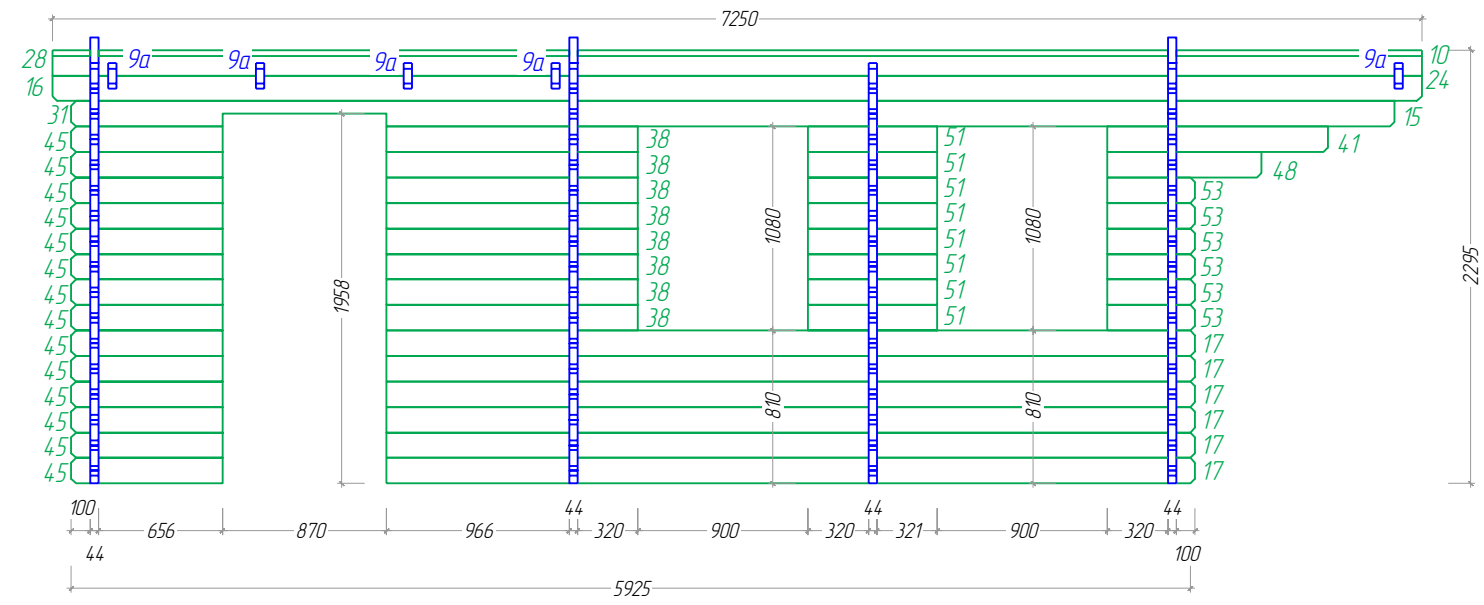

D

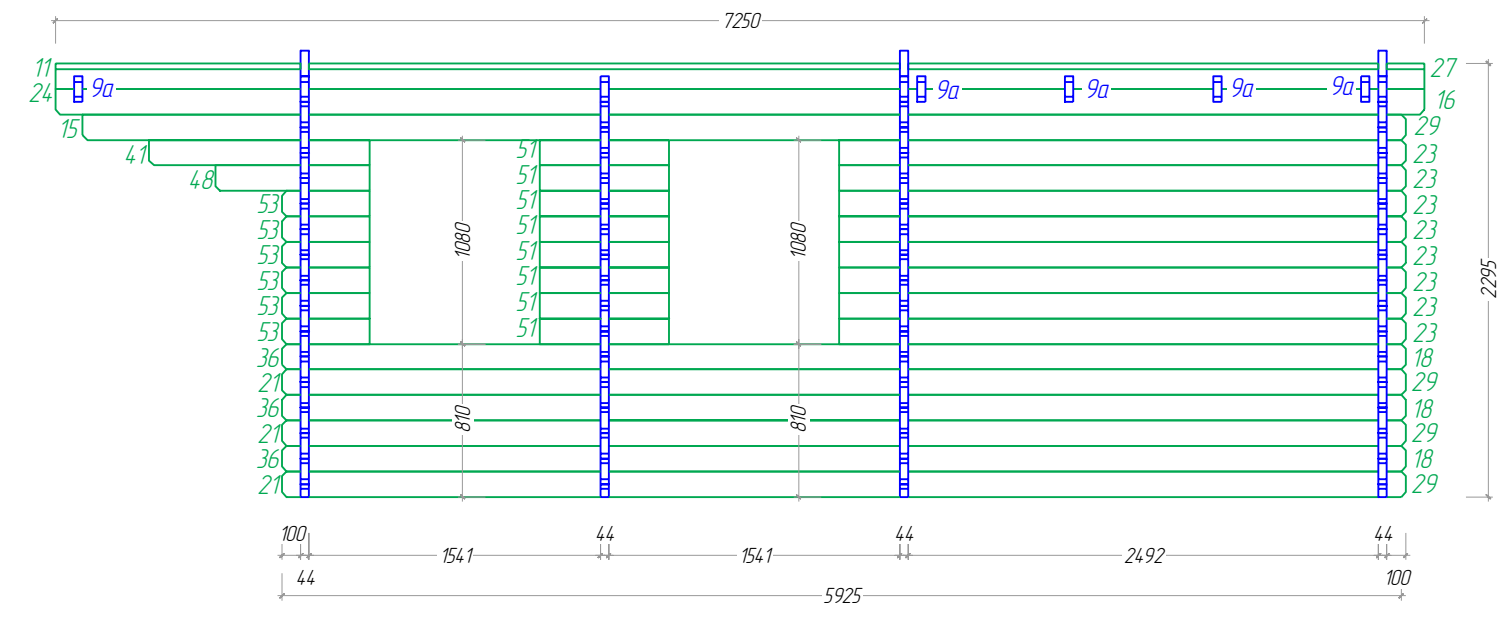

(E)

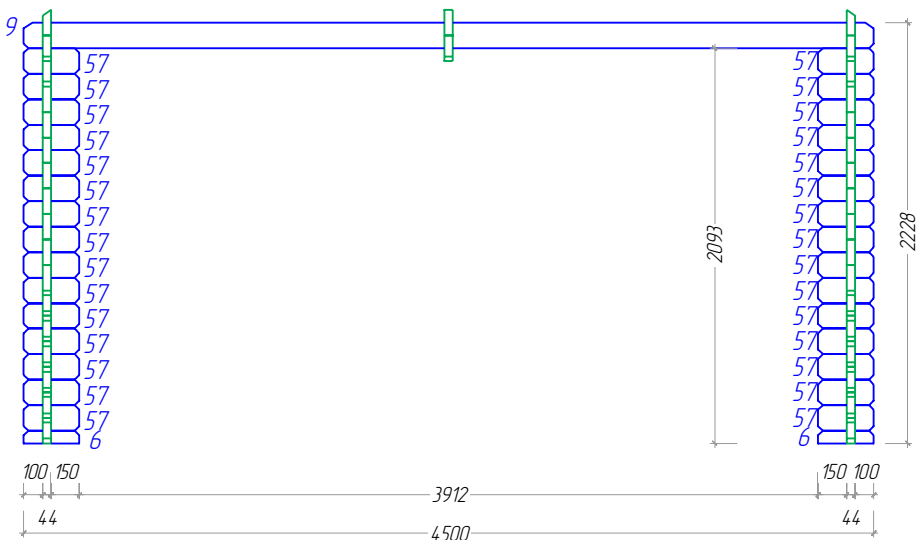

(F)

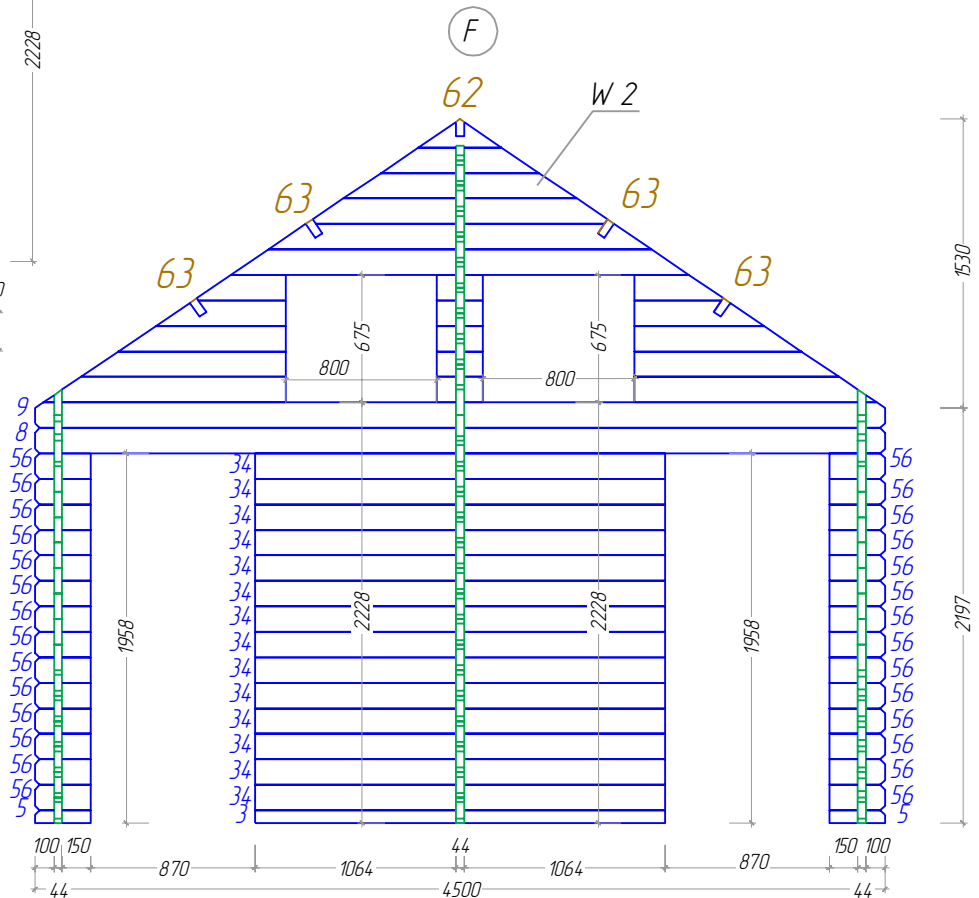

G

Silvan 44 4.5x6

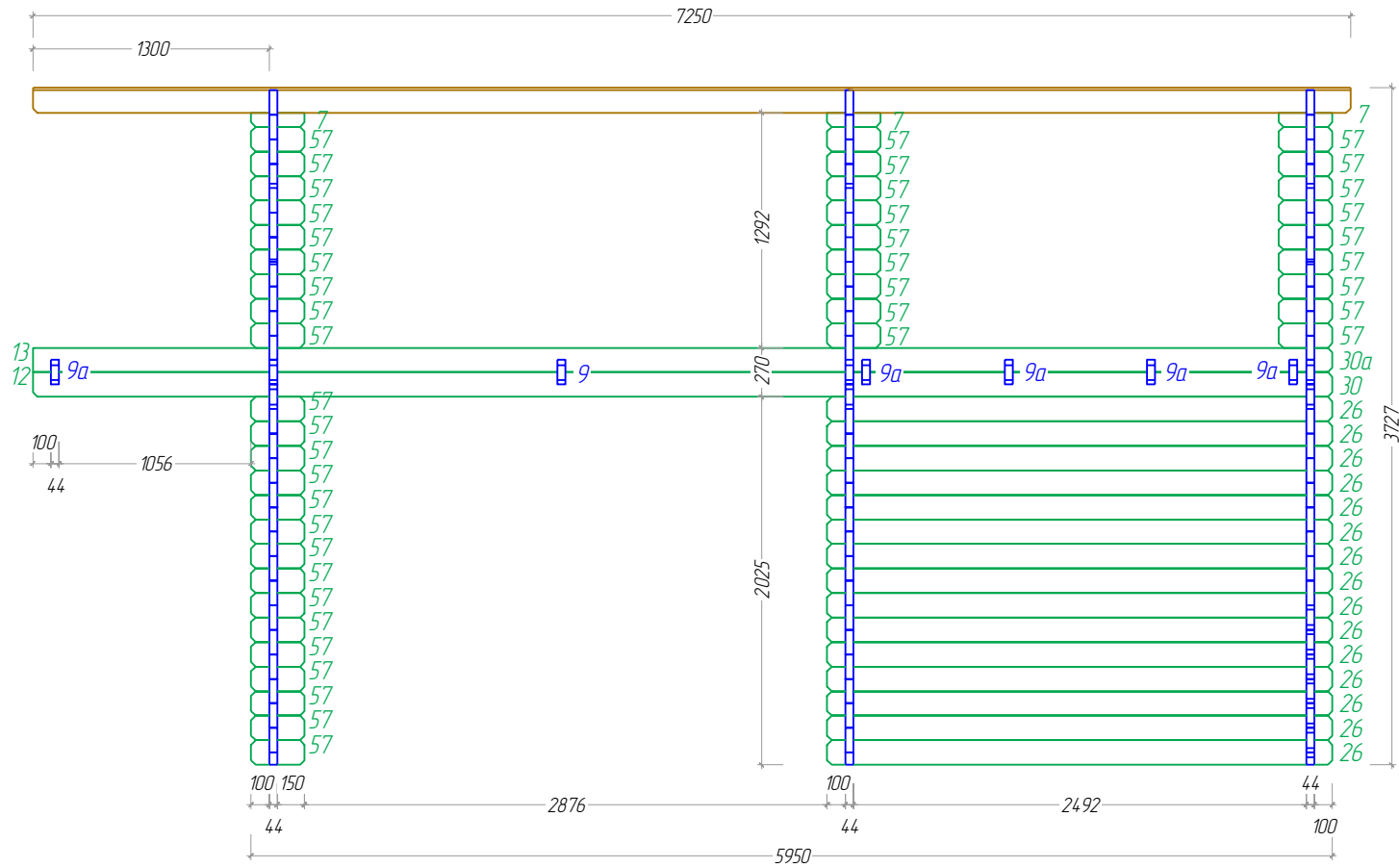



Silvan 44 4.5x6

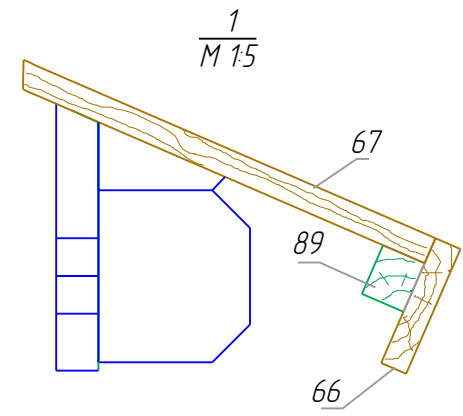
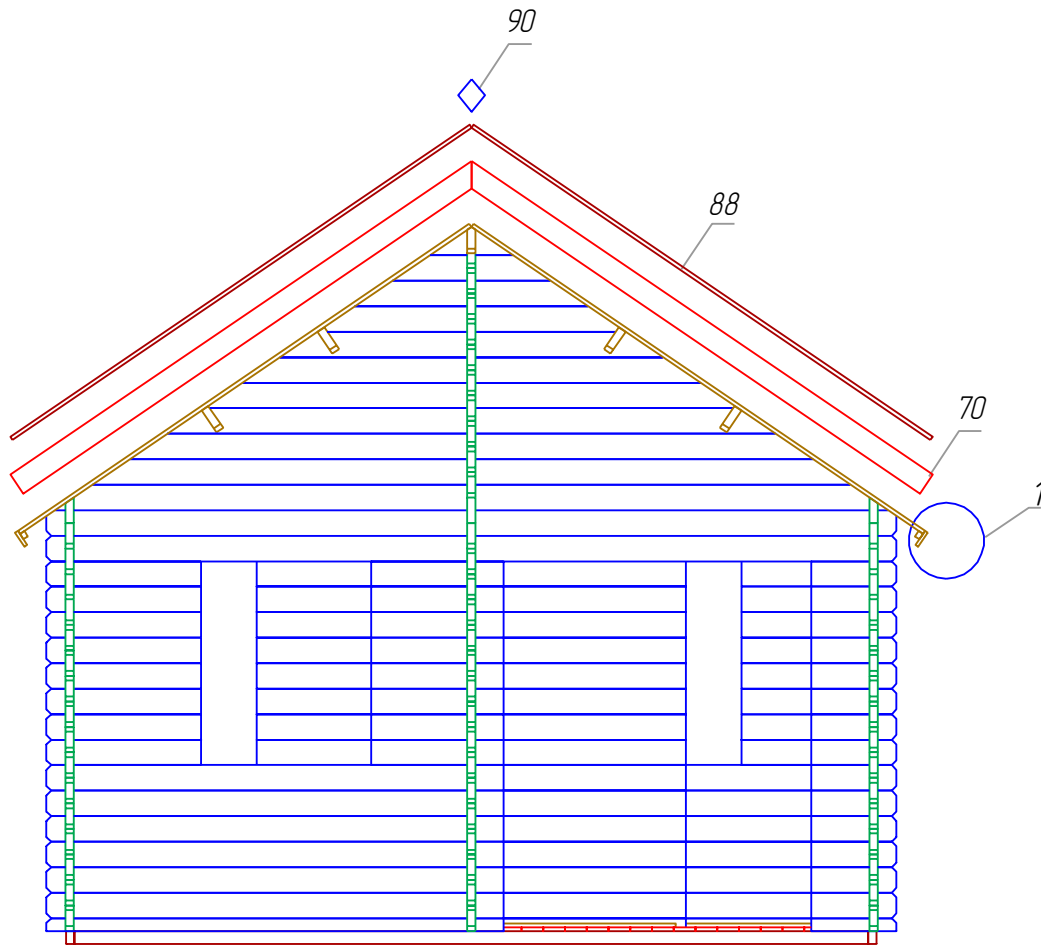

Silvan 44 4.5x6

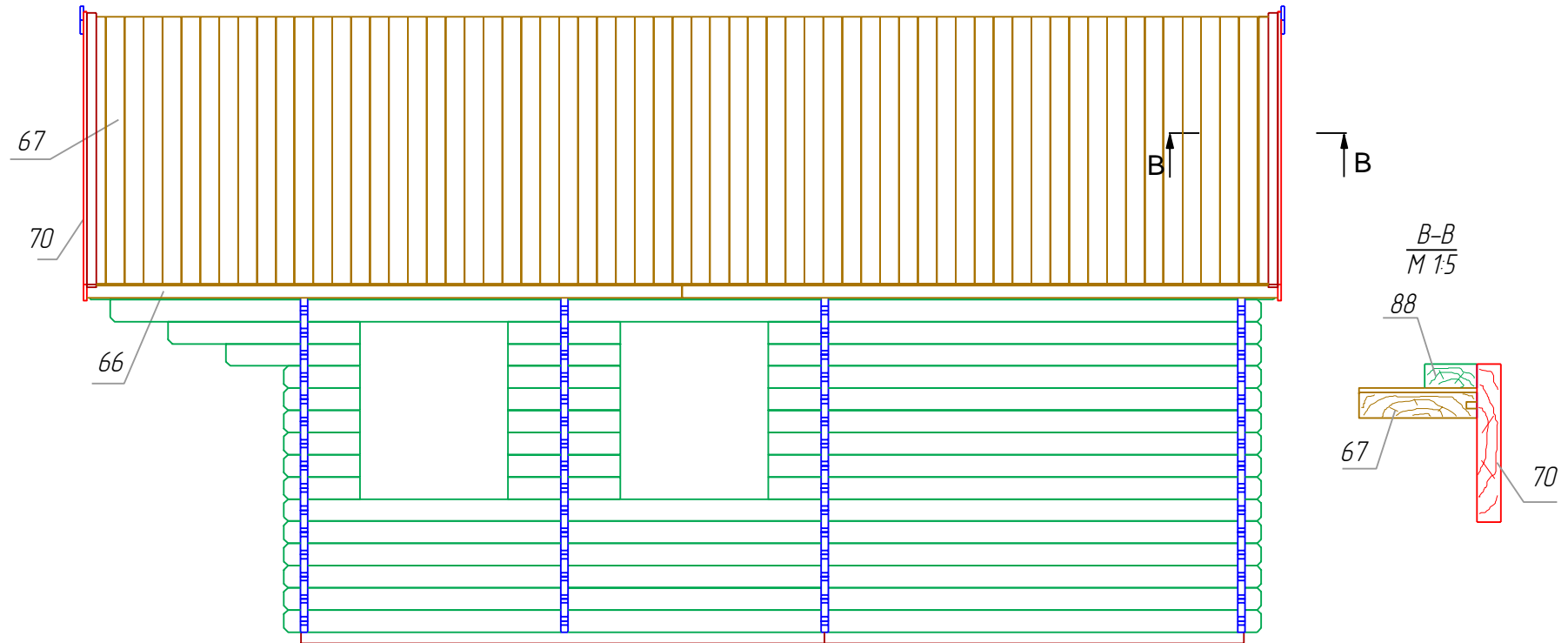

# Silvan 44 4.5x6

*Boarding joist plan*

*Trummplan*

*Lambourde plan*

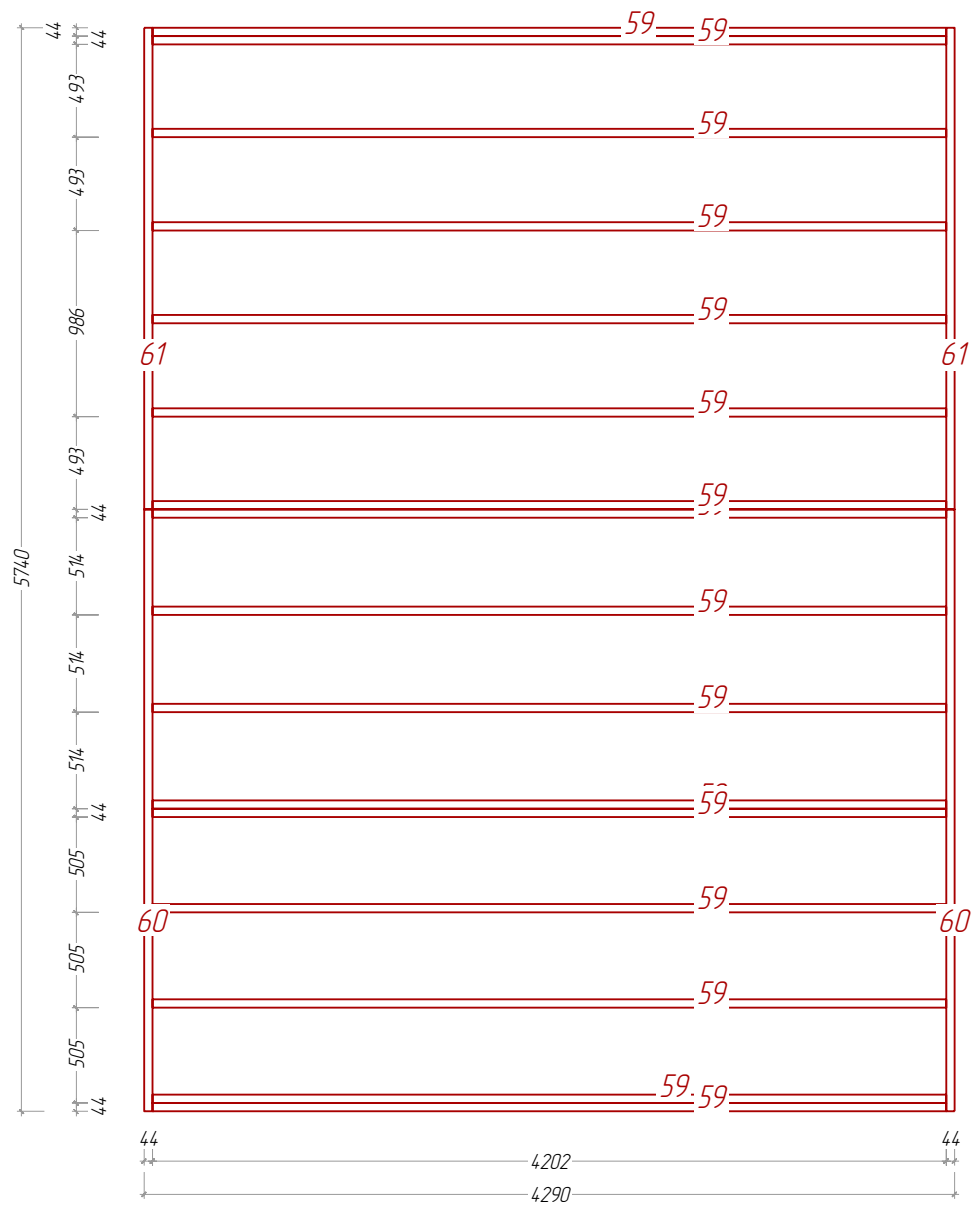



# Silvan 44 4.5x6

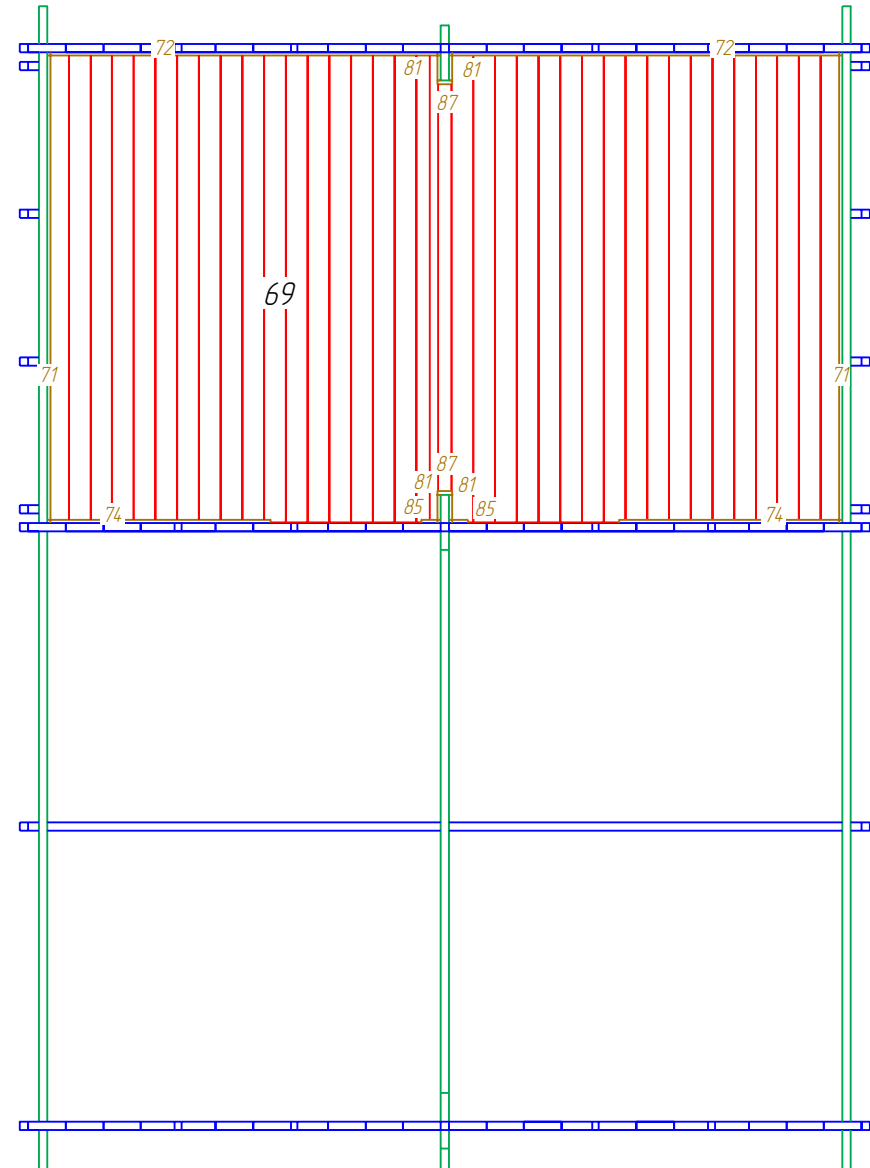
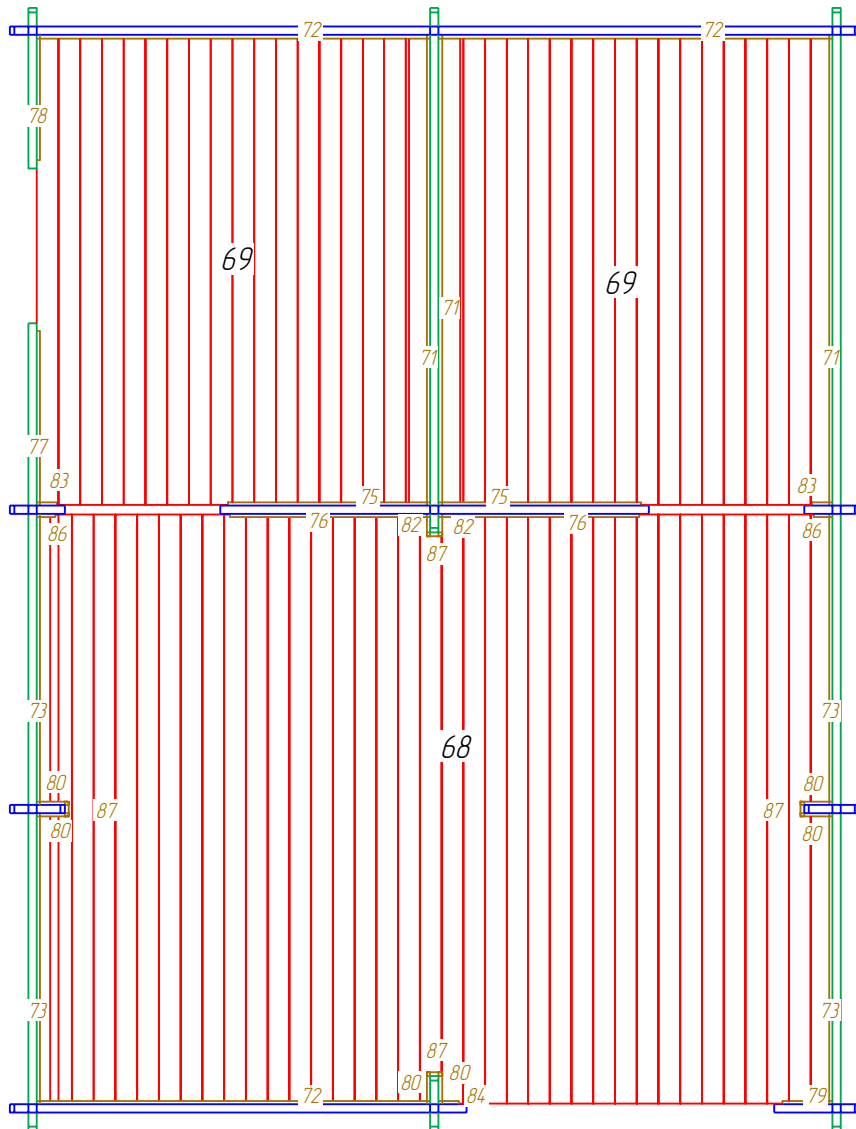





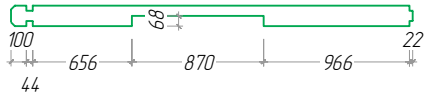
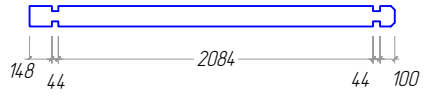
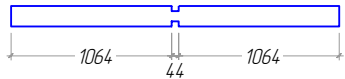
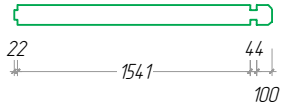
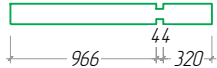
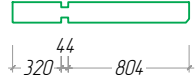
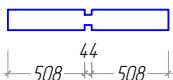
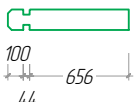
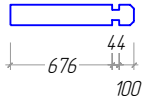
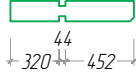
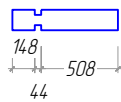
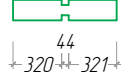

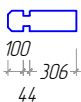
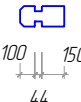

Plan of the floor board  
Plan der Furbodenbretter  
Le plan des plaches du plancher



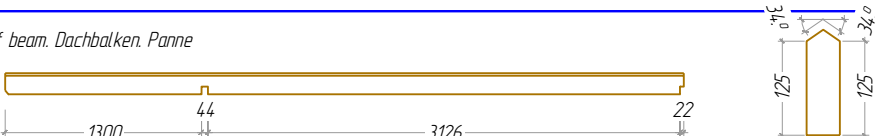

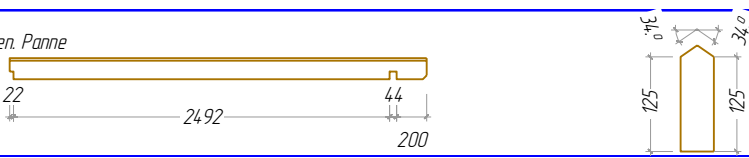
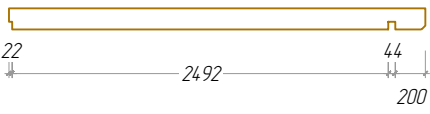





№	Silvan 44 4.5x6	Nr.	Profile (mm)	Lenght (mm)
1		1	44x 67.5	4500mm
2		1	44x 67.5	2420mm
3		1	44x 67.5	2172mm
4		1	44x 67.5	450mm
5		2	44x 67.5	294mm
6		2	44x 67.5	294mm
7		3	44x 77.5	294mm
8		9	44x 135	4500mm
9		4	44x 135	4500mm
9a		5	44x 135	4500mm
10		1	44x 135	4492mm
11		1	44x 135	4492mm
12		1	44x 135	4492mm

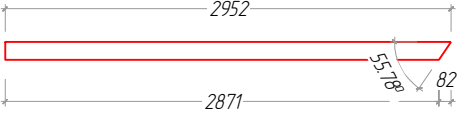







Nº	Silvan 44 4.5x6	Nr.	Profile (mm)	Length (mm)
13		1	44x 135	4492mm
15		2	44x 135	4348mm
16		2	44x 135	4343mm
17		6	44x 135	4280mm
18		3	44x 135	4243mm
21		3+1	44x 135	3292mm
23		8	44x 135	3000mm
24		2	44x 135	2907mm
26		15	44x 135	2780mm
27		1	44x 135	2758mm
28		1	44x 135	2758mm
29		4+1	44x 135	2658mm
30		1	44x 135	2658mm
30a		1	44x 135	2658mm

Nº	Silvan 44 4.5x6	Nr.	Profile (mm)	Length (mm)
31		1	44x 135	2658mm
33		6	44x 135	2420mm
34		14	44x 135	2172mm
36		3	44x 135	1707mm
38		8	44x 135	1330mm
41		2	44x 135	1169mm
43		8	44x 135	1060mm
45		14	44x 135	800mm
47		24	44x 135	820mm
48		2	44x 135	817mm
49		8	44x 135	700mm
51		16	44x 135	685mm
53		12	44x 135	465mm

Nº	Silvan 44 4.5x6	Nr.	Profile (mm)	Lenght (mm)
54		14	44x 135	450mm
56		28	44x 135	294mm
57		72	44x 135	294mm
59	Foundation Fundament Solive 	16	44x 68	4202mm
60	Foundation Fundament Solive 	2	44x 68	3187mm
61	Foundation Fundament Solive 	2	44x 68	2553mm
62	Roof beam. Dachbalken. Panne 	1	44x 140	4492mm
63	Roof beam. Dachbalken. Panne 	4	44x 140	4492mm
64	Roof beam. Dachbalken. Panne 	1	44x 140	2758mm
65	Roof beam. Dachbalken. Panne 	4	44x 140	2758mm
66	Roof side boards Traufenbrett Planche de rive 	4	18x 90	3625mm
67	Roof boards. Dachbretter Volige 	128+1	20x 115	2891mm
68	Floor boards Fu ssboden Lame de plancher 	37+1	20x 115	3122mm



Nº	Silvan 44 4.5x6	Nr.	Profile (mm)	Lenght (mm)
69	Floor boards Fu ssboden Lame de plancher 	76+1	20x 115	2488mm
70	Fascia board Giebelblende Planch de rive facade 	4	20x120	2952mm
71	Floor edge trim Fu bleisten Plinthe plancher 	5	20x18	2492mm
72	Floor edge trim Fu bleisten Plinthe plancher 	5	20x18	2084mm
73	Floor edge trim Fu bleisten Plinthe plancher 	4	20x18	1541mm
74	Floor edge trim Fu bleisten Plinthe plancher 	2	20x18	1184mm
75	Floor edge trim Fu bleisten Plinthe plancher 	2	20x18	1071mm
76	Floor edge trim Fu bleisten Plinthe plancher 	2	20x18	1061mm
77	Floor edge trim Fu bleisten Plinthe plancher 	1	20x18	923mm
78	Floor edge trim Fu bleisten Plinthe plancher 	1	20x18	663mm
79	Floor edge trim Fu bleisten Plinthe plancher 	1	20x18	263mm
80	Floor edge trim Fu bleisten Plinthe plancher 	6	20x18	168mm
81	Floor edge trim Fu bleisten Plinthe plancher 	4	20x18	150mm

Nº	Silvan 44 4.5x6	Nr.	Profile (mm)	Lenght (mm)
82	Floor edge trim Fu bleisten Plinthe plancher 	2	20x18	118mm
83	Floor edge trim Fu bleisten Plinthe plancher 	2	20x18	107mm
84	Floor edge trim Fu bleisten Plinthe plancher 	1	20x18	105mm
85	Floor edge trim Fu bleisten Plinthe plancher 	2	20x18	100mm
86	Floor edge trim Fu bleisten Plinthe plancher 	2	20x18	97mm
87	Floor edge trim Fu bleisten Plinthe plancher 	6	20x18	80mm
88	Roofing felt fillet Giebelabschlussbrett Latte de finition couverture 	4	20x58	2939mm
89	Roof edge reinforcement Traufenteisteu Tasseau 	4	28x34	3625mm
90	Diamond Raute Diamant 	2	20x120	120mm
91	Storm protection 	4	28x34	1900mm
	Door Tur La porte 1630x1958mm (с остеклением полным)	1		
	Door Tur La porte 870x1958mm	3		
	Window Fenetre Fenster 900x1080mm	7		

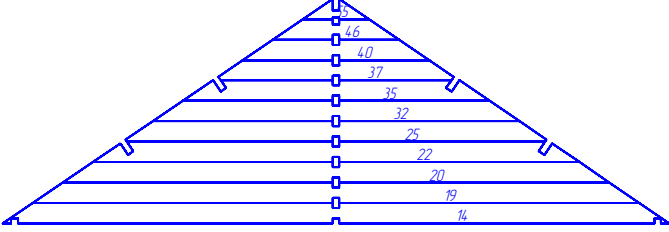
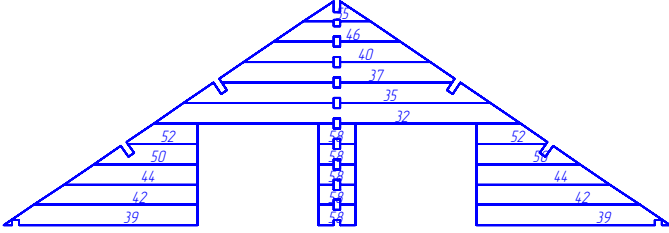
Nº	Silvan 44 4.5x6	Nr.	Profile (mm)	Lenght (mm)
W1		2		
W2		1		

Silvan 44 4.5x6

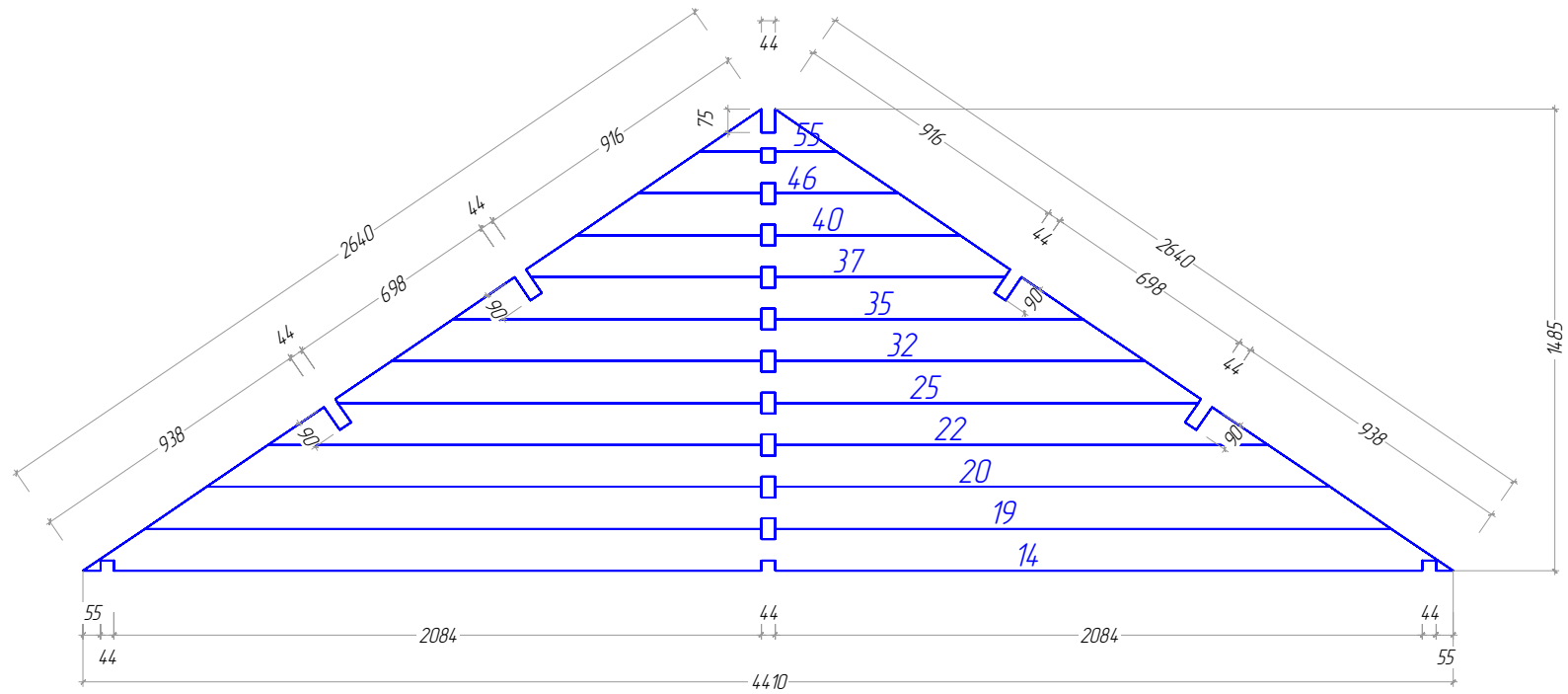

Silvan 44 4.5x6

