

Leo 44 3x4 TP

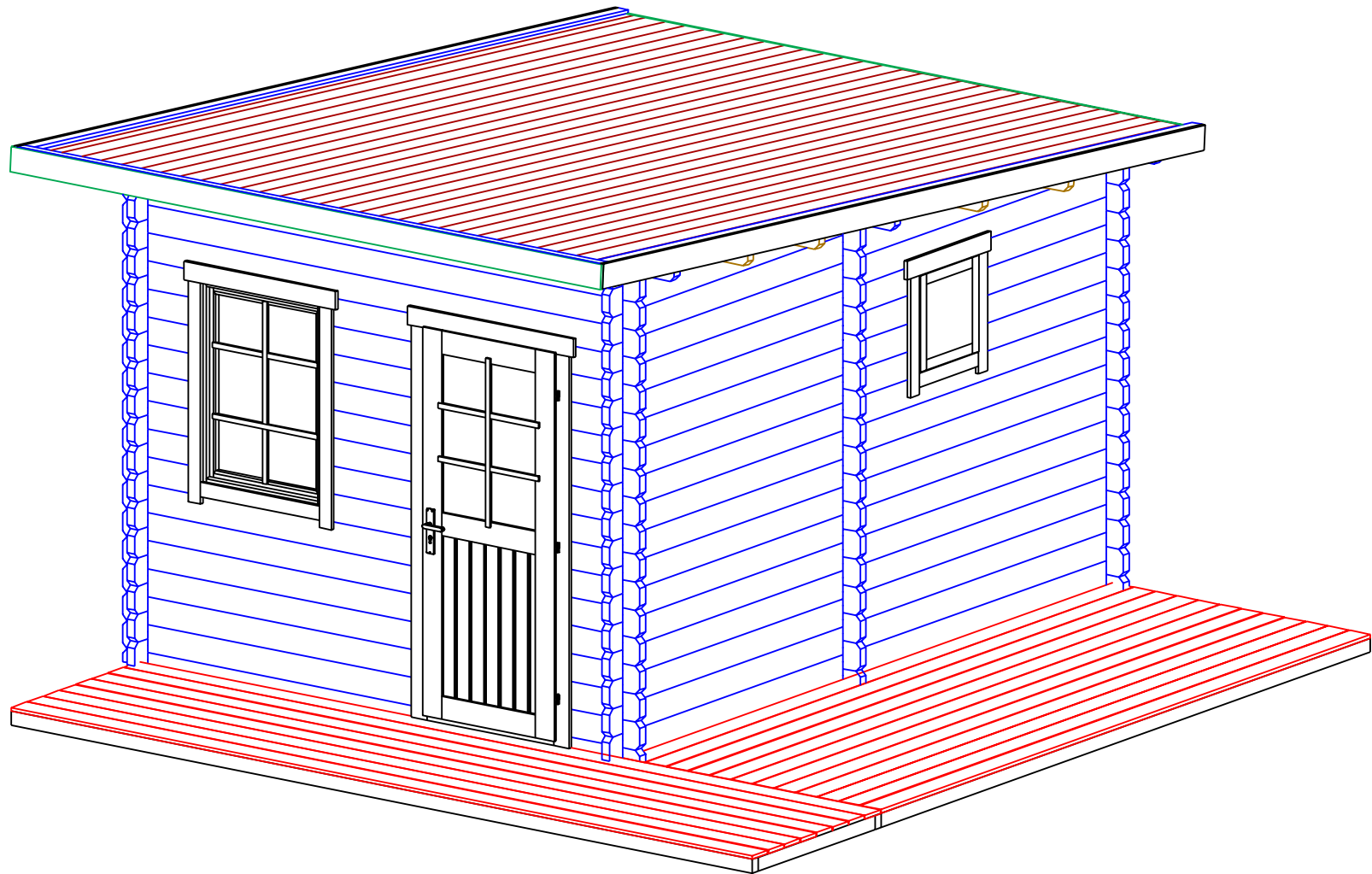

Leo 44 3x4 TP

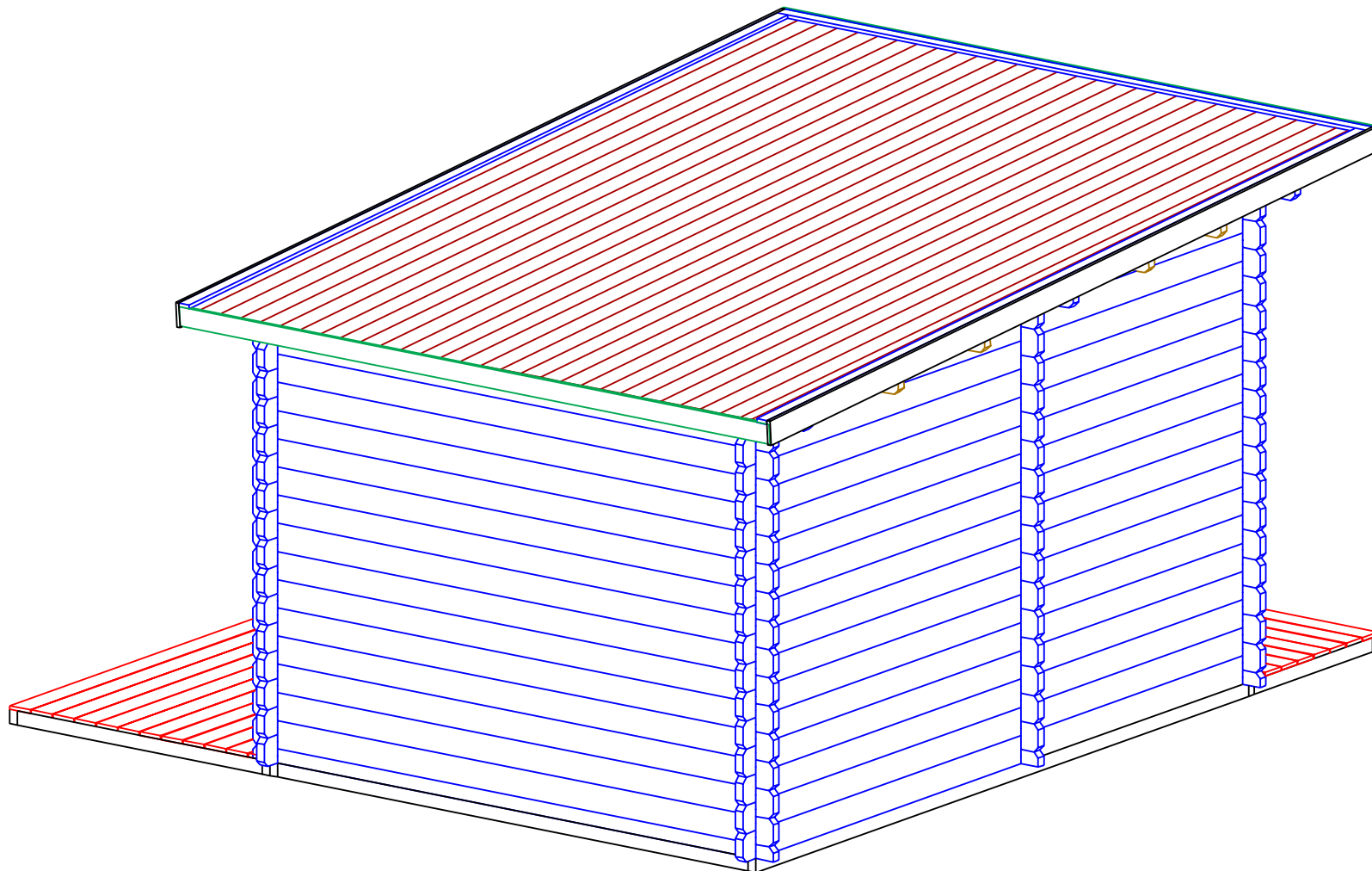

Leo 44 3x4 TP

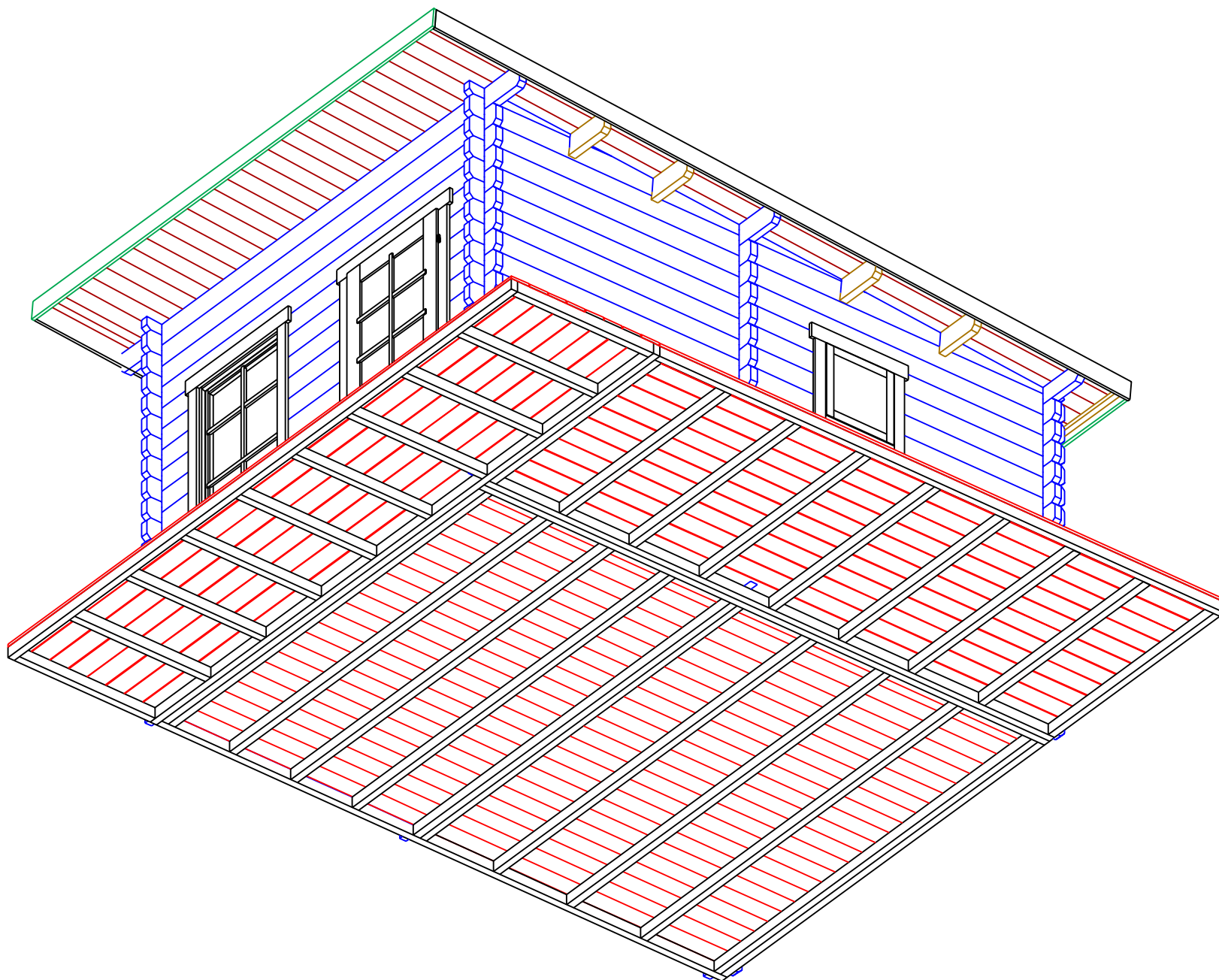

Leo 44 3x4 TP
Plan

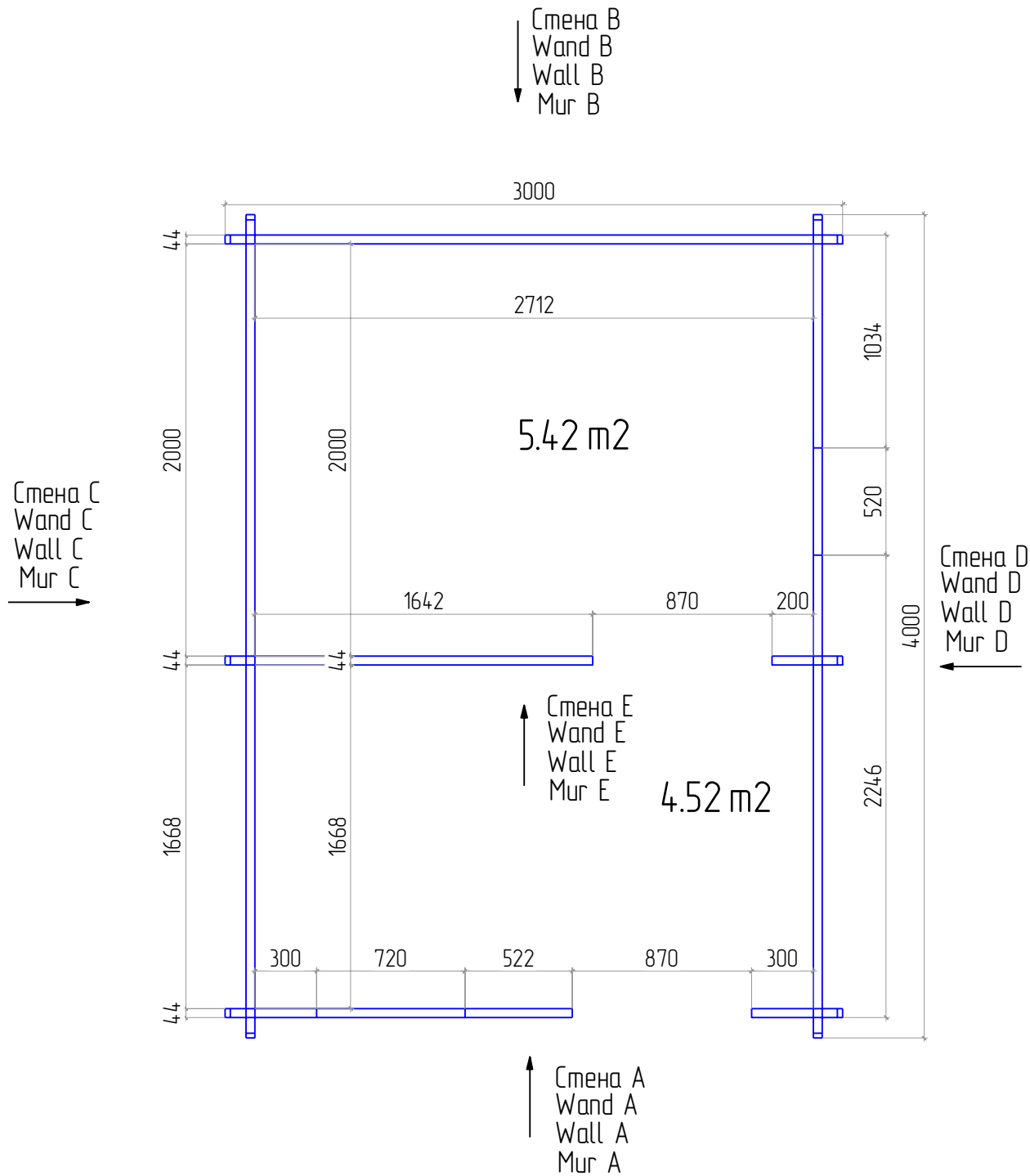

Leo 44 3x4 TP

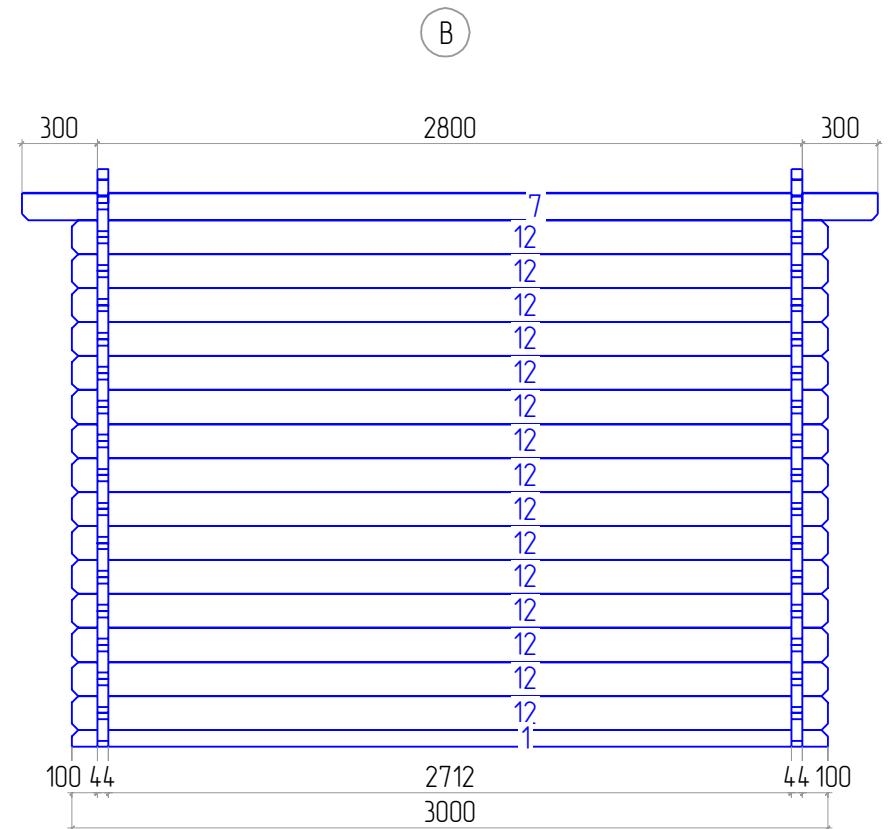
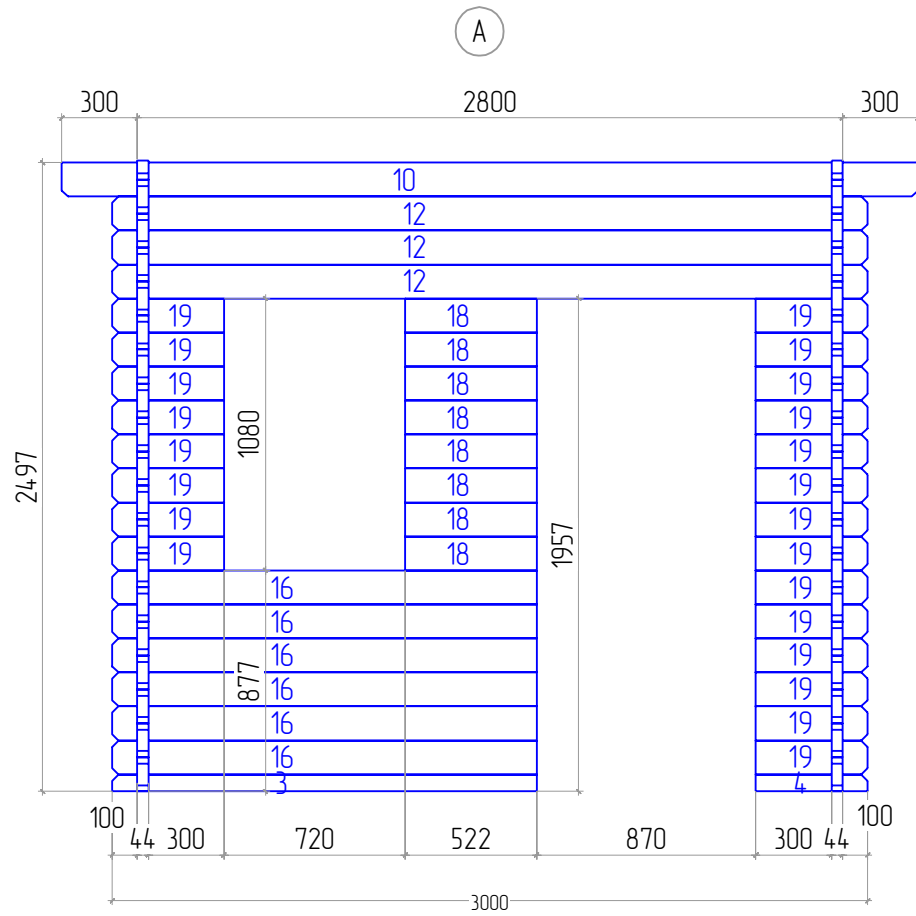

Leo 44 3x4 TP

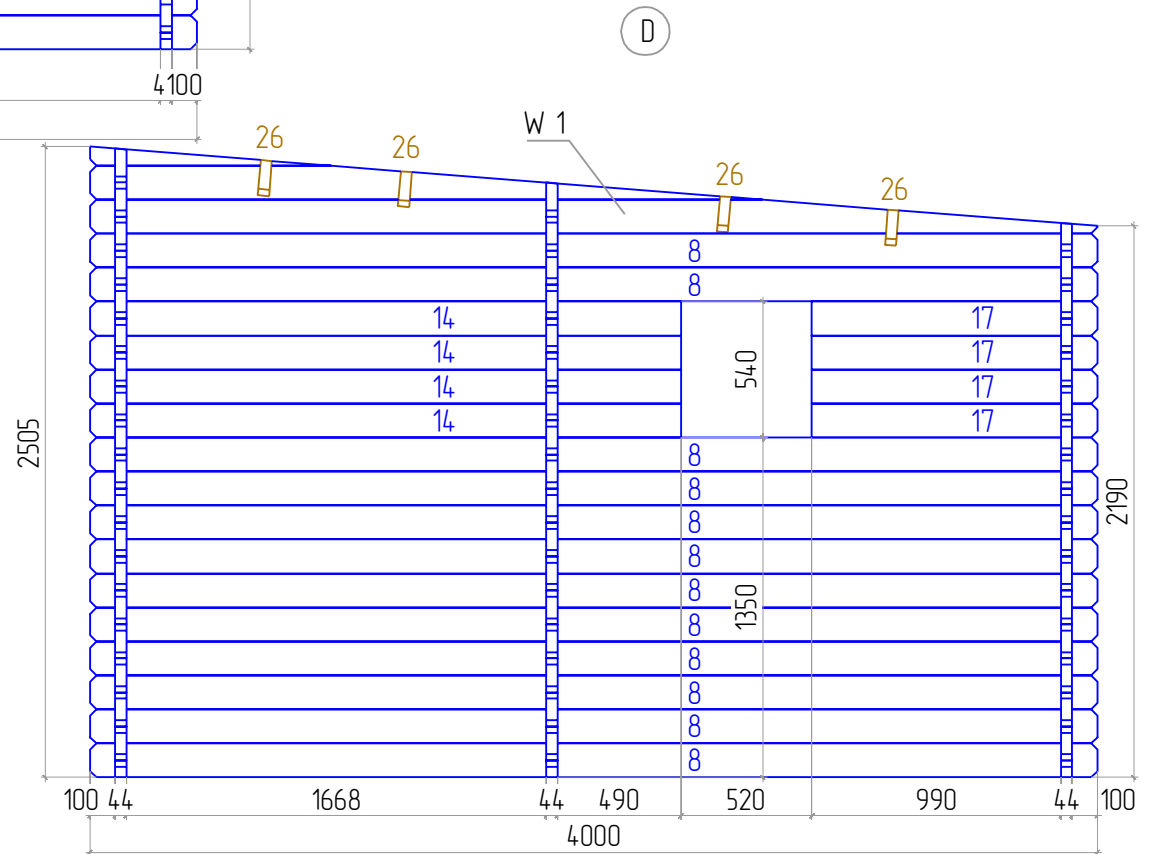
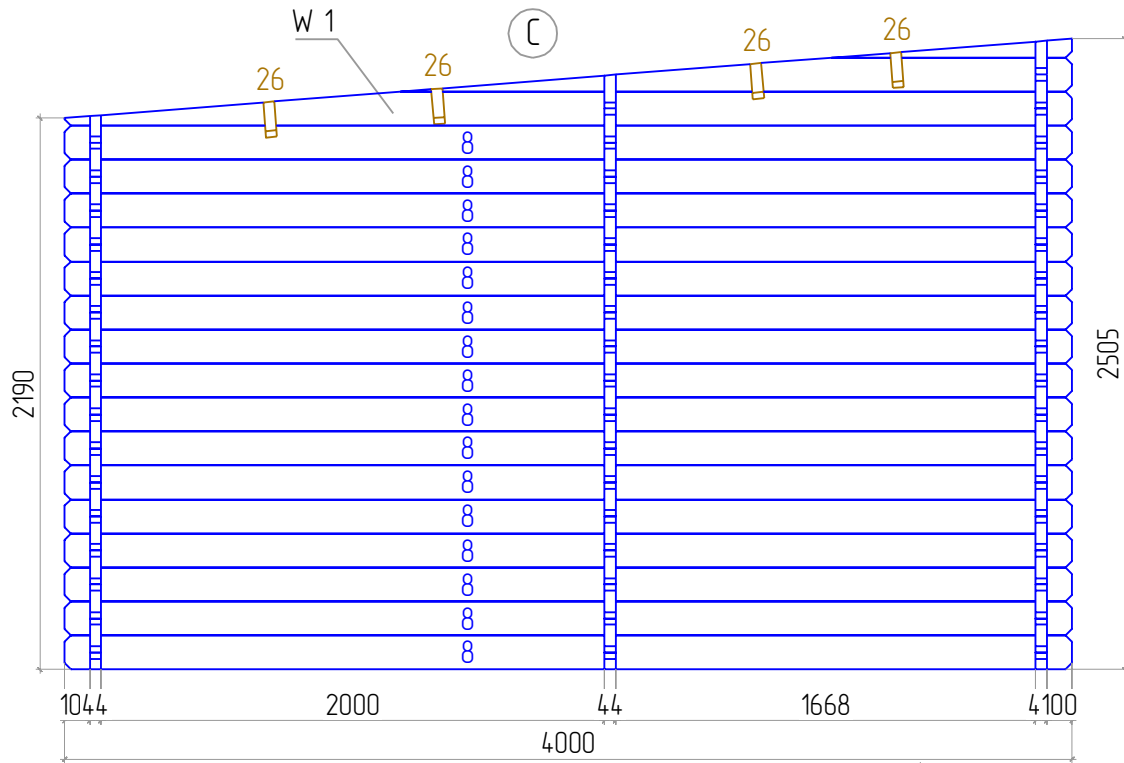

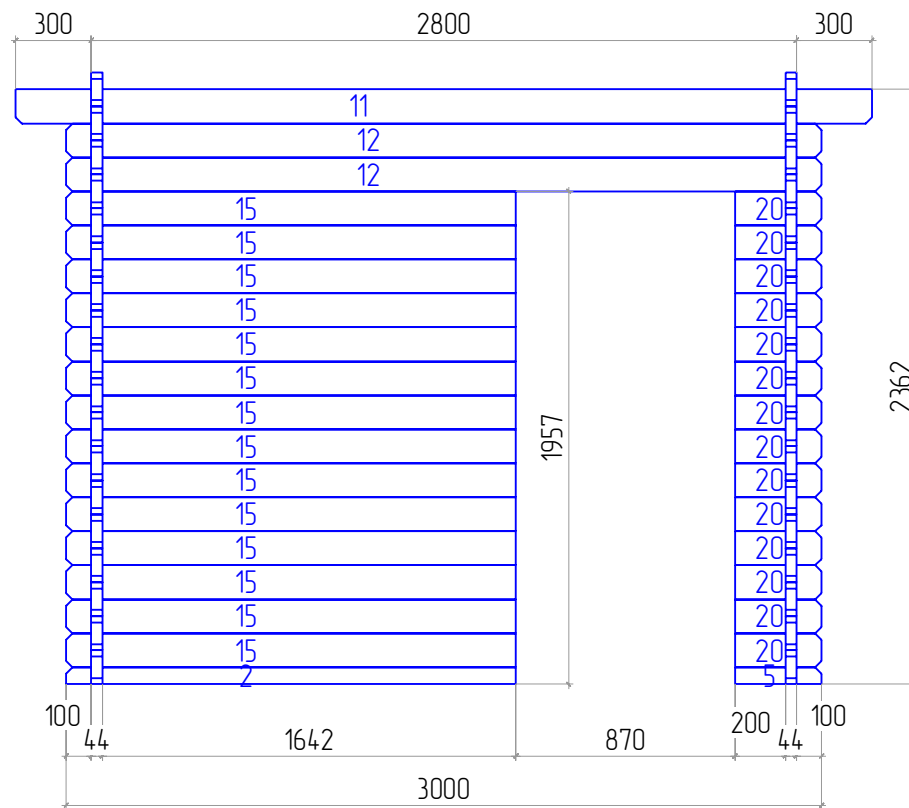

Leo 44 3x4 TP

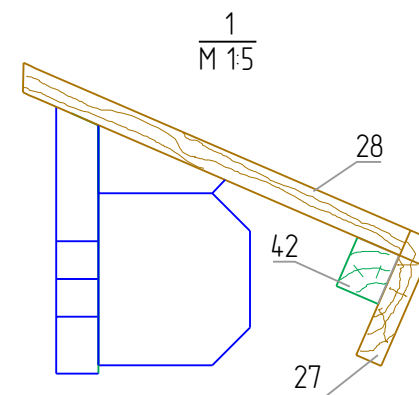
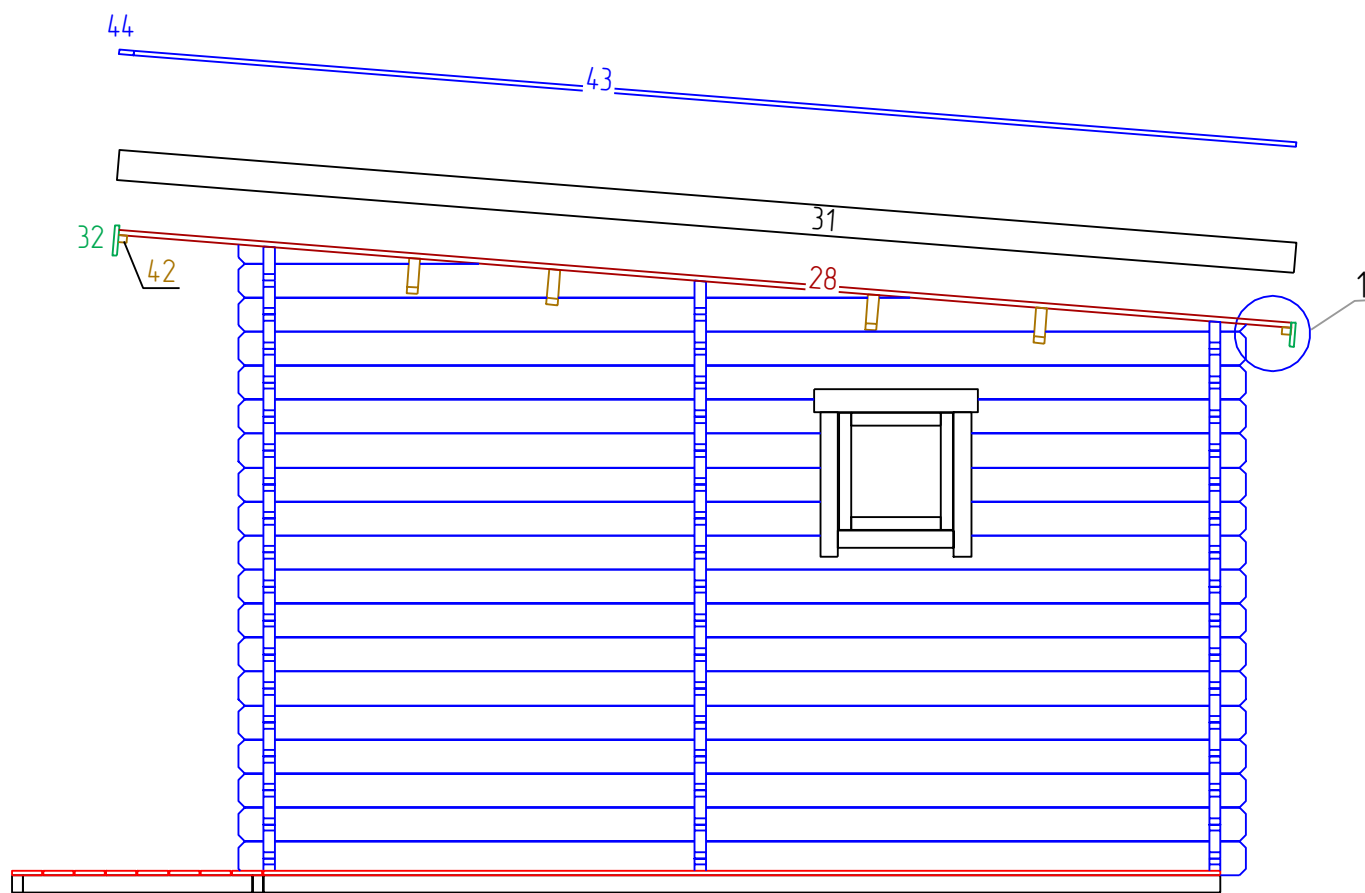

Leo 44 3x4 TP

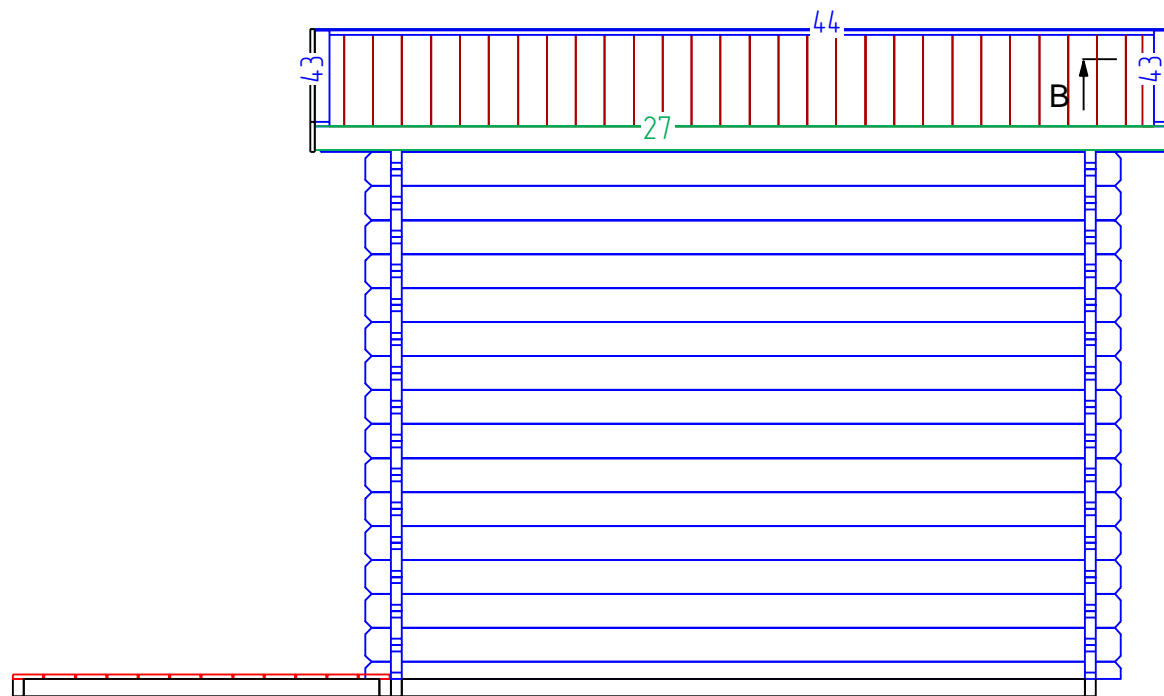

B

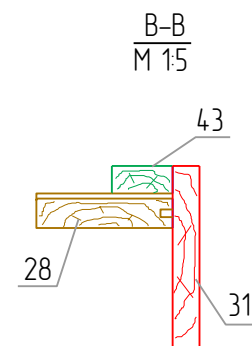

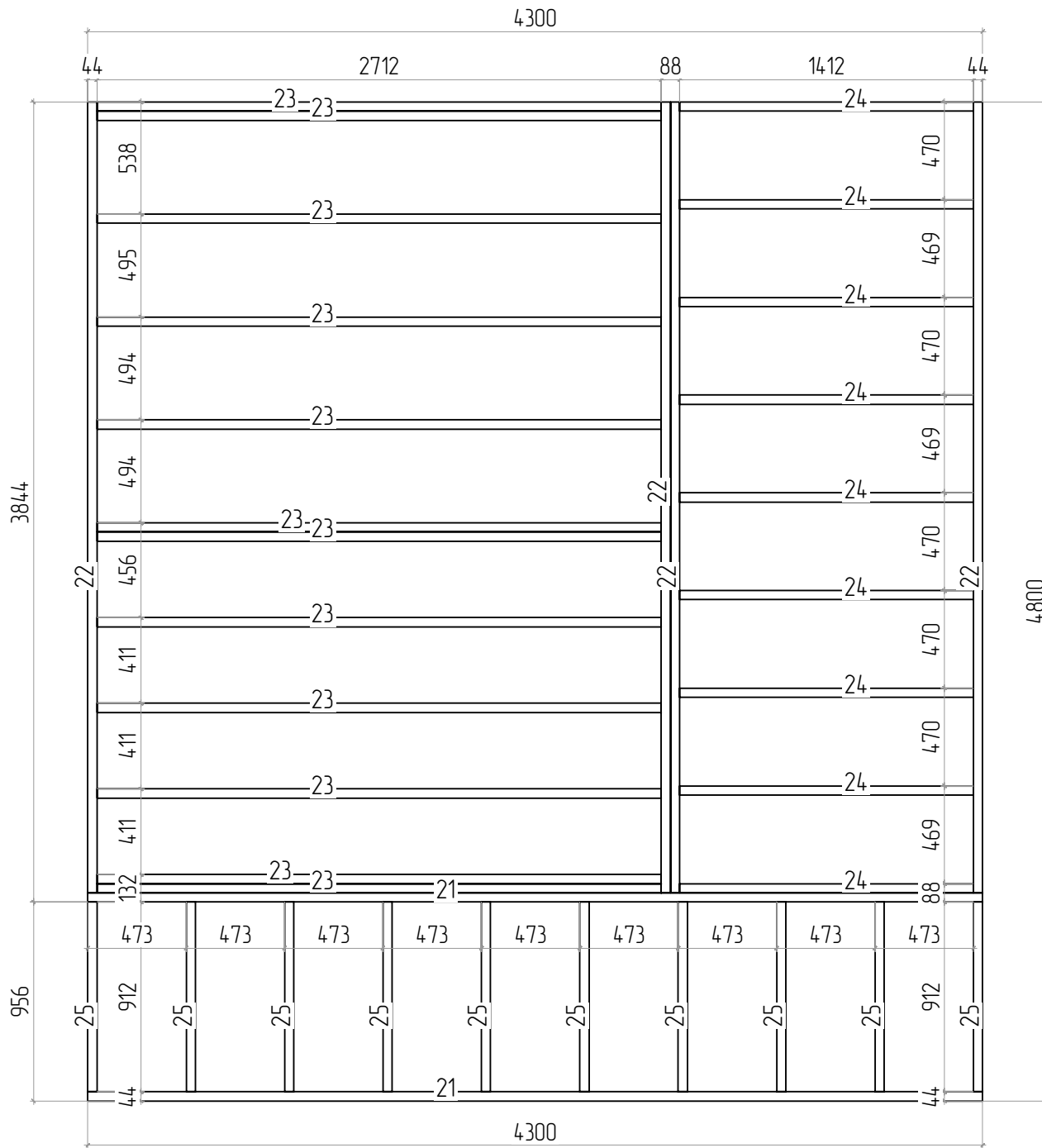





Leo 44 3x4 TP



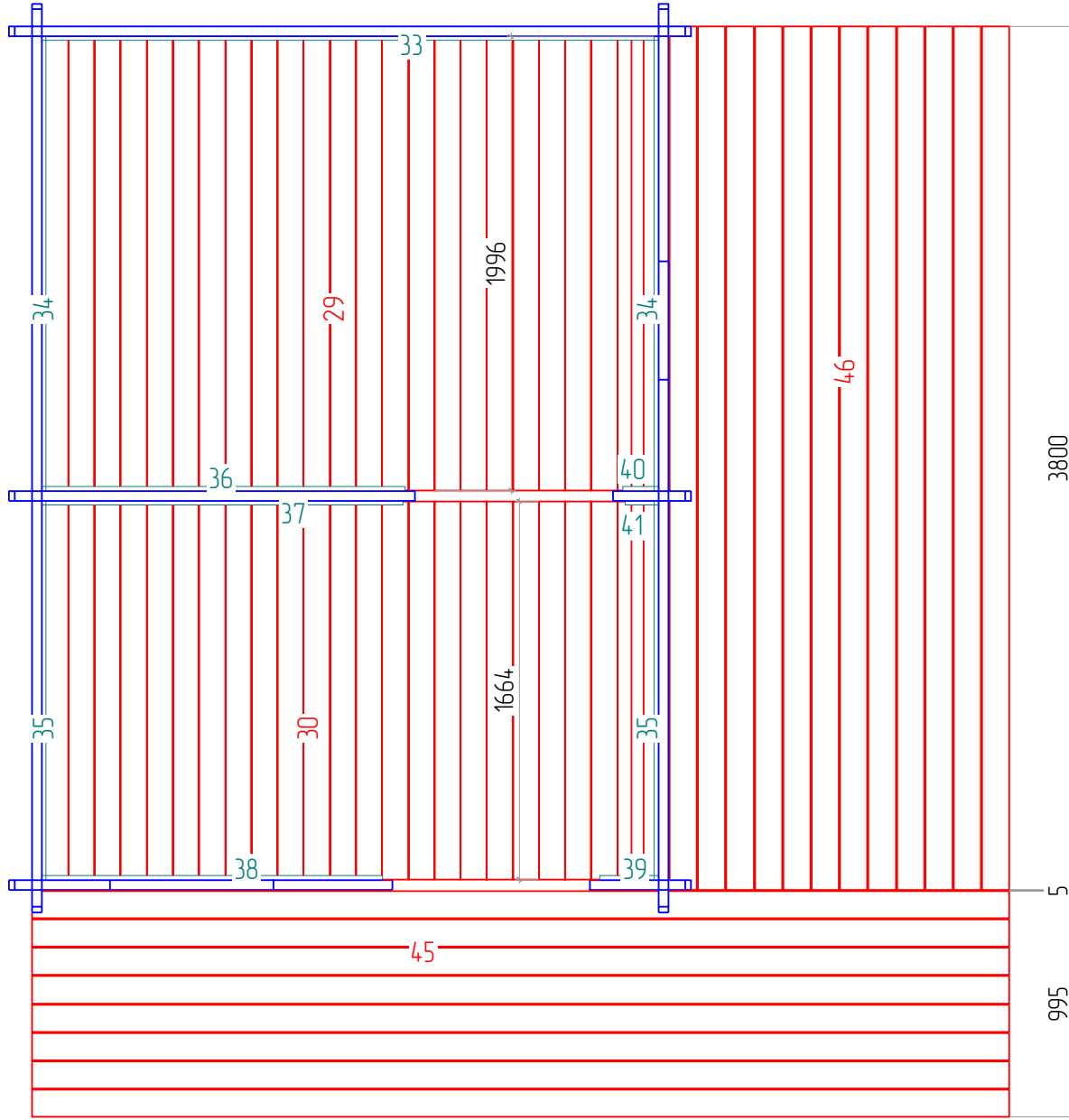

Boarding joist plan
 Trummplan
 Lambourde plan

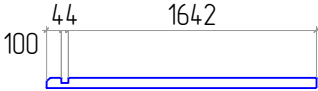
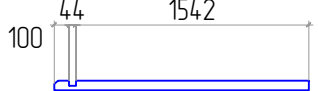
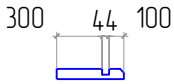
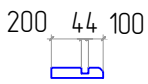
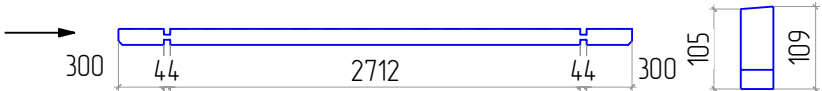
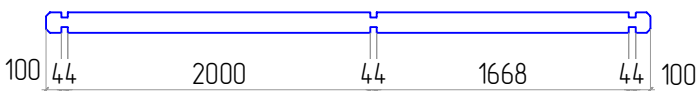
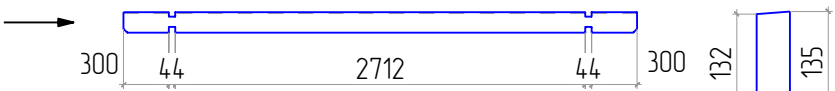
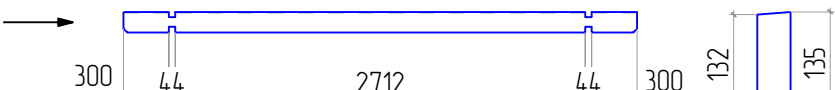

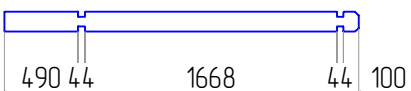
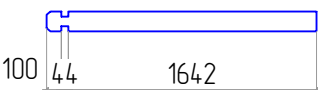
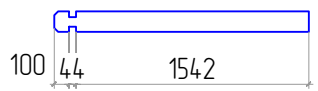

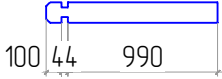

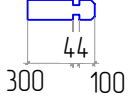
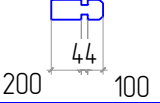
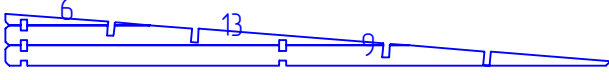
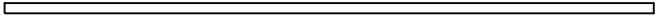
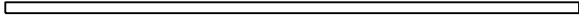
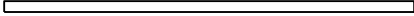
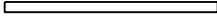
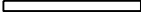
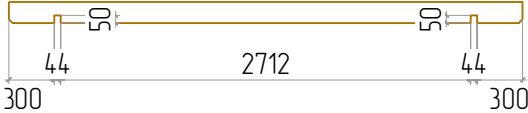



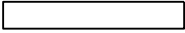

Leo 44 3x4 TP





Plan of the floor board
Plan der Furbodenbretter
Le plan des plaches du plancher



Nº	Leo 44 3x4 TP	Nr.	Profile (mm)	Lenght (mm)
1		1	44x67.5	3000mm
2		1	44x67.5	1786mm
3		1	44x67.5	1686mm
4		1	44x67.5	444mm
5		1	44x67.5	344mm
7		1	44x109	3400mm
8		29	44x135	4000mm
10		1	44x135	3400mm
11		1	44x135	3400mm
12		20	44x135	3000mm
14		4	44x135	2346mm
15		14	44x135	1786mm
16		6	44x135	1686mm

Nº	Leo 44 3x4 TP	Nr.	Profile (mm)	Lenght (mm)
17		4	44x135	1134mm
18		8	44x135	522mm
19		22	44x135	444mm
20		14	44x135	344mm
W1		2		
21	Foundation Fundament Solve 	2	44x68	4300mm
22	Foundation Fundament Solve 	4	44x68	3800mm
23	Foundation Fundament Solve 	12	44x68	2712mm
24	Foundation Fundament Solve 	9	44x68	1412mm
25	Foundation Fundament Solve 	10	44x68	912mm
26	Roof beam. Dachbalken. Panne 	4	44x140	3400mm
27	Fascia board Giebelblende Planch de rive facade 	1	18x95	3400mm
28	Roof boards Dachbretter Valige 	31	20x115	4670mm

Nº	Leo 44 3x4 TP	Nr.	Profile (mm)	Lenght (mm)
29	Floor boards Fu ssboden Lame de plancher 	25	20x115	1996mm
30	Floor boards Fu ssboden Lame de plancher 	24	20x115	1664mm
31	Fascia board Giebelblende Planch de rive facade 	2	18x120	4688mm
32	Fascia board Giebelblende Planch de rive facade 	1	18x120	3424mm
33	Floor edge trim Fu bleisten Plinthe plancher 	1	18x20	2712mm
34	Floor edge trim Fu bleisten Plinthe plancher 	2	18x20	2000mm
35	Floor edge trim Fu bleisten Plinthe plancher 	2	18x20	1668mm
36	Floor edge trim Fu bleisten Plinthe plancher 	1	18x20	1599mm
37	Floor edge trim Fu bleisten Plinthe plancher 	1	18x20	1589mm
38	Floor edge trim Fu bleisten Plinthe plancher 	1	18x20	1499mm
39	Floor edge trim Fu bleisten Plinthe plancher 	1	18x20	257mm
40	Floor edge trim Fu bleisten Plinthe plancher 	1	18x20	157mm
41	Floor edge trim Fu bleisten Plinthe plancher 	1	18x20	147mm

№	Leo 44 3x4 TP	№.	Profile (mm)	Length (mm)
42	Roof edge reinforcement Traufenleiste Tasseau 	2	28x34	3400mm
43	Roofing felt fillet Giebelabschlussbrett Latte de finition couverture 	2	18x58	4630mm
44	Roofing felt fillet Giebelabschlussbrett Latte de finition couverture 	1	18x58	3388mm
45		9	18x120	4300mm
46		12	18x120	3800mm
	Door Тур 1958x870 мм (50% остекление) La porte	2		
	Window 540x520 мм	1		