

Lido / Terje
Art. Nr. 284700
1/8



3.02.2018

Art.Nr. 284700

Groundplan - Grundplan - Plan de masse -
Planimetria - Plattegrond - Põhiplaan

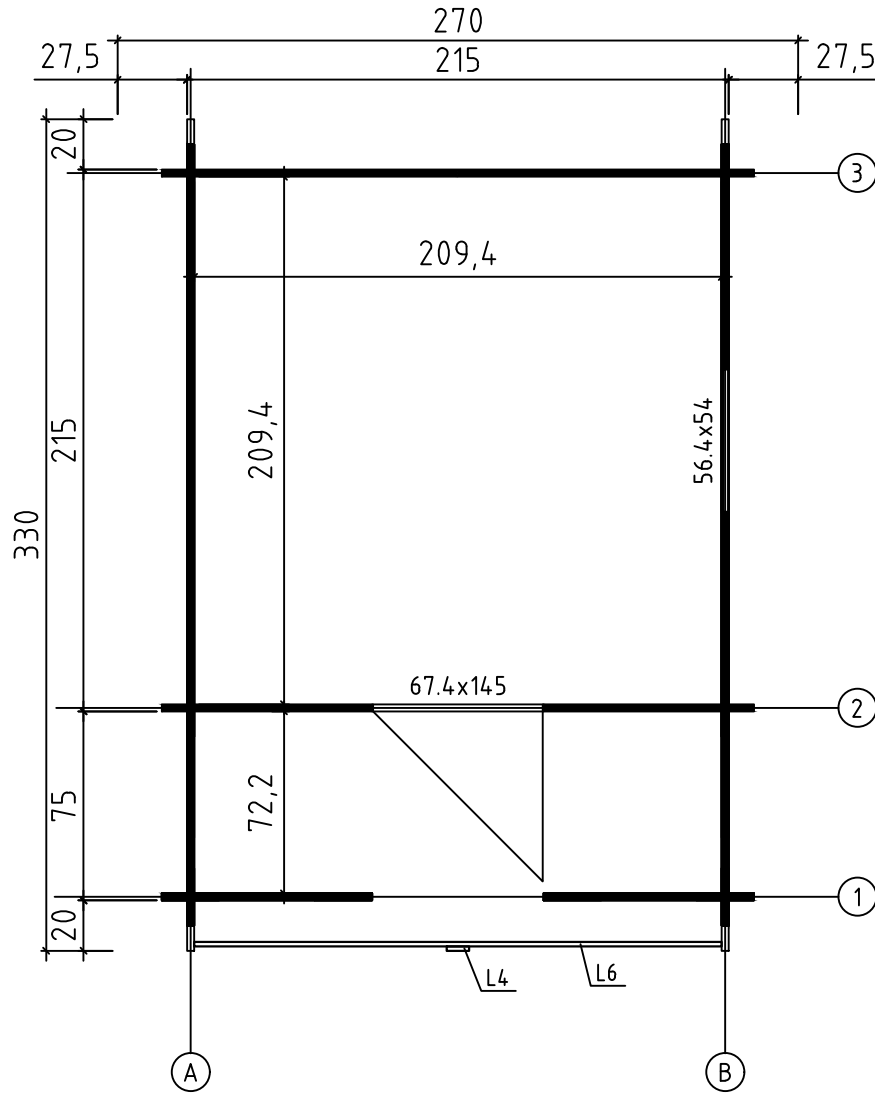

Art.Nr. 284700

Foundation - Fundament - Fondation -
Fondamenta - Fundering - Immutatud alusraam

Floor boards - Fussbodenbretter - Plan pose plancher -
Pavimento - Vloerhout - Põrandalaudis

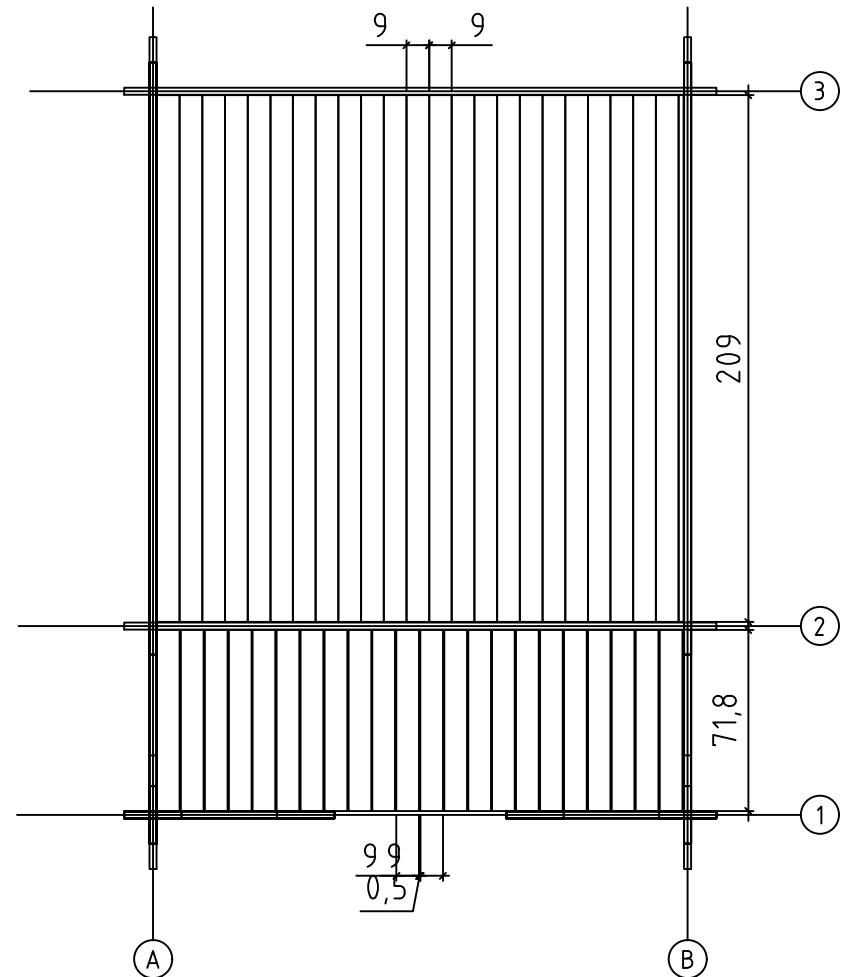
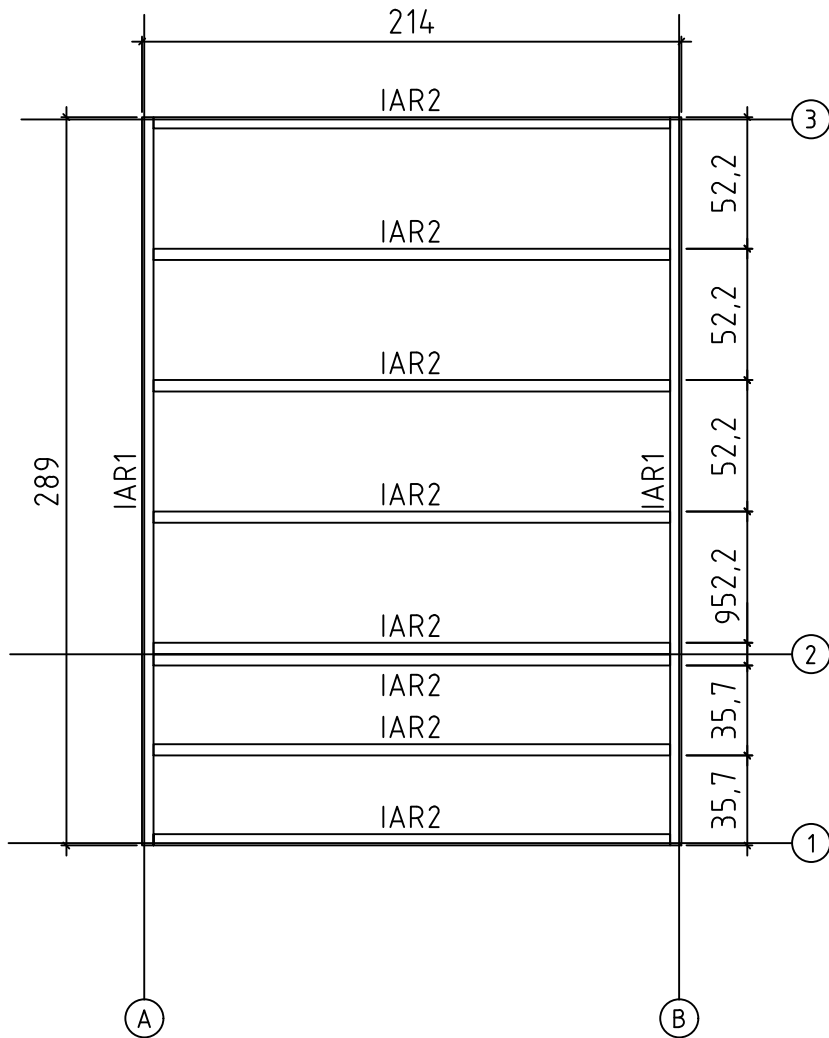





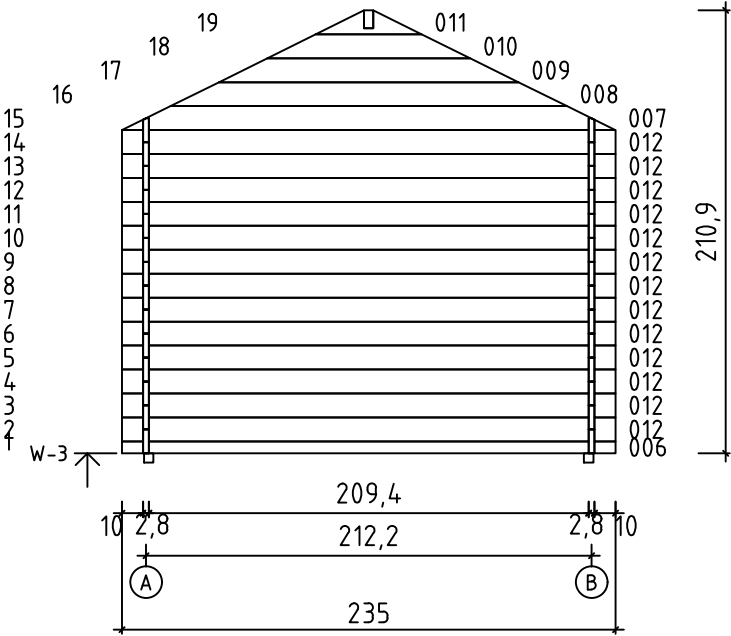
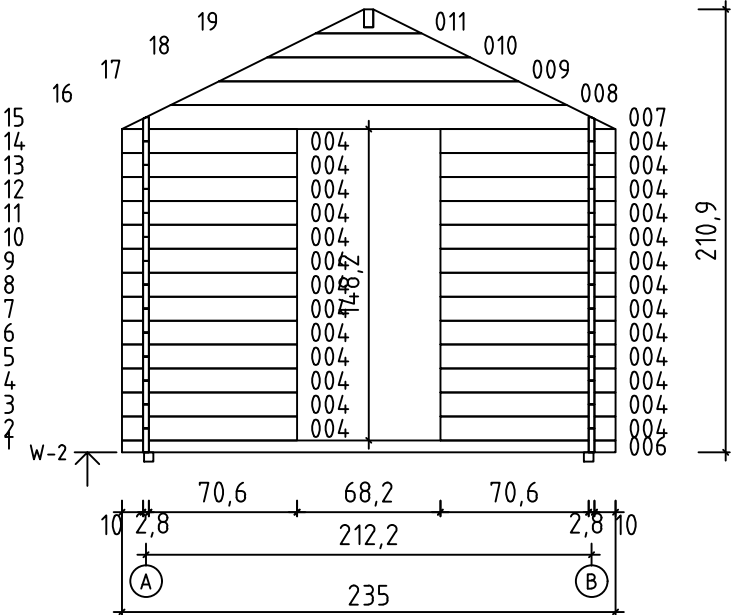
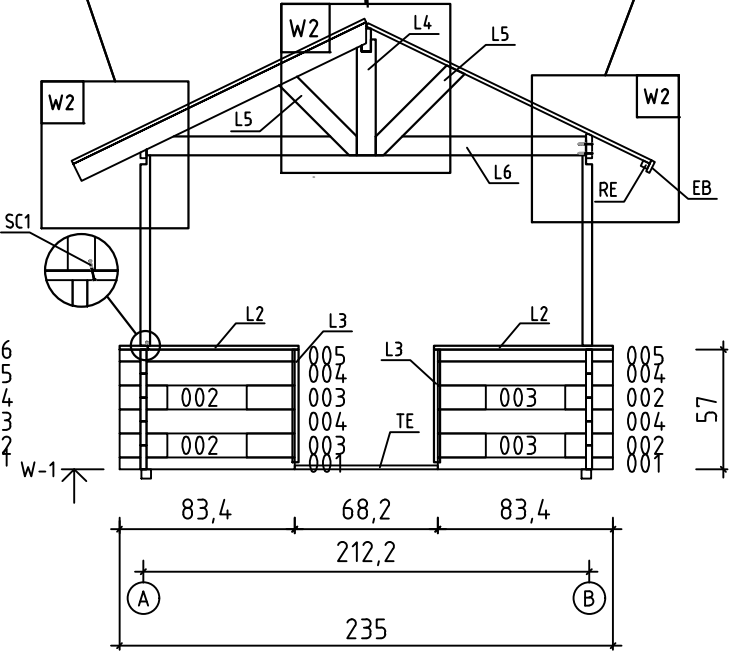
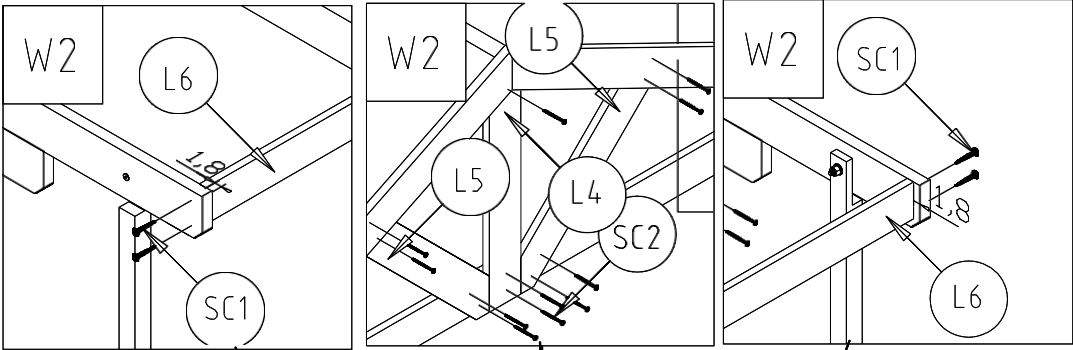



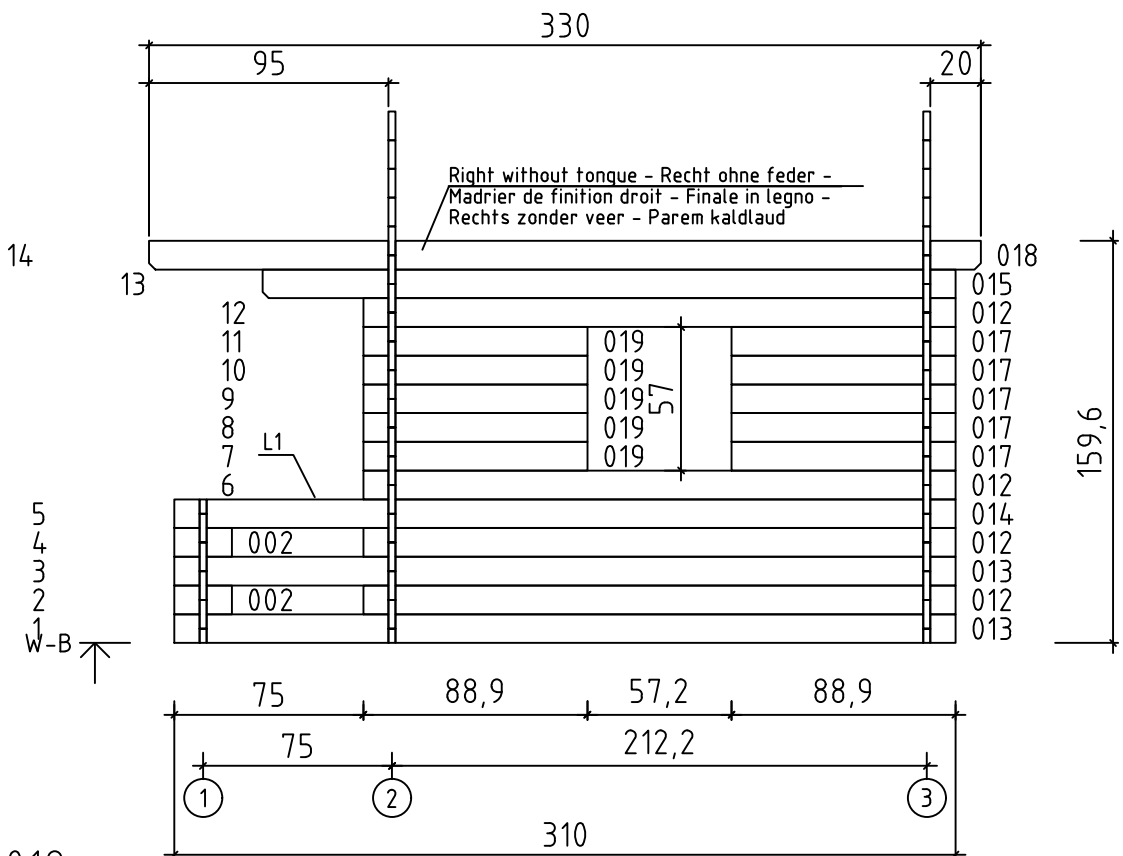
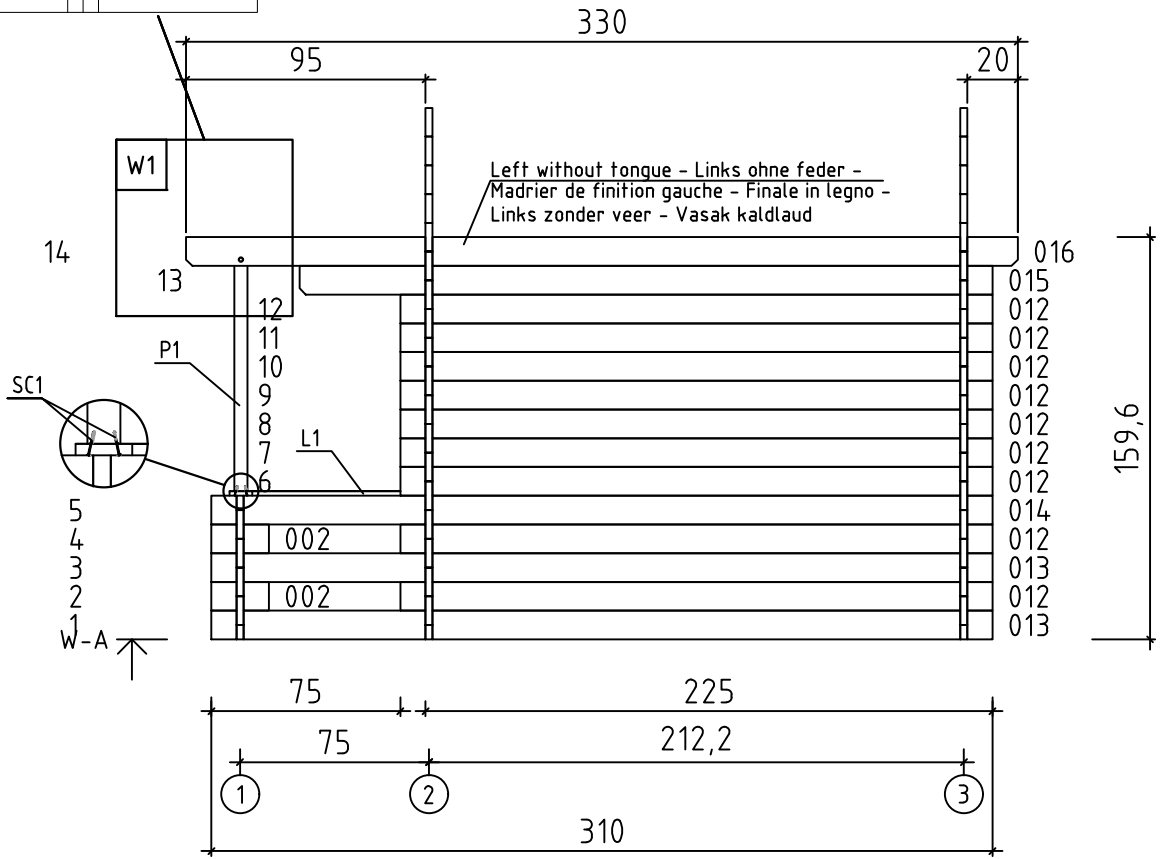
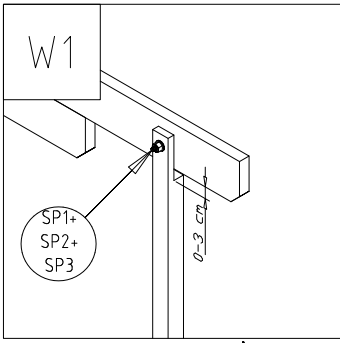

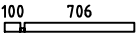

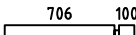
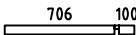
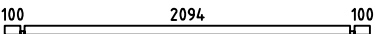
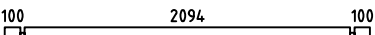
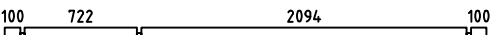
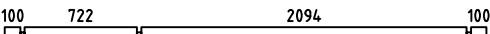
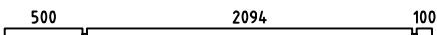
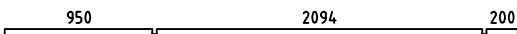
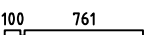
Terrace boards - Terrassenbretter - Plancher de terrasse -
Piattaforme terrazzo - Terrasvloer - Terrassilaudis

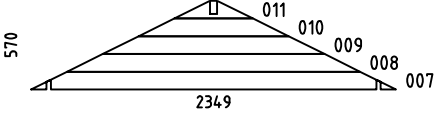
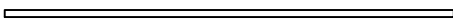

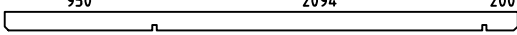







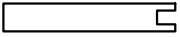
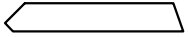
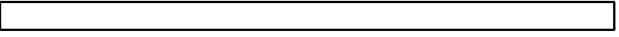

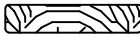

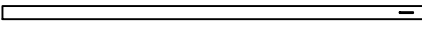

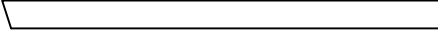
Art.Nr. 284700



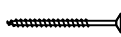

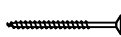
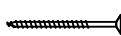

Art.Nr. 284700



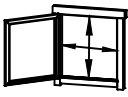
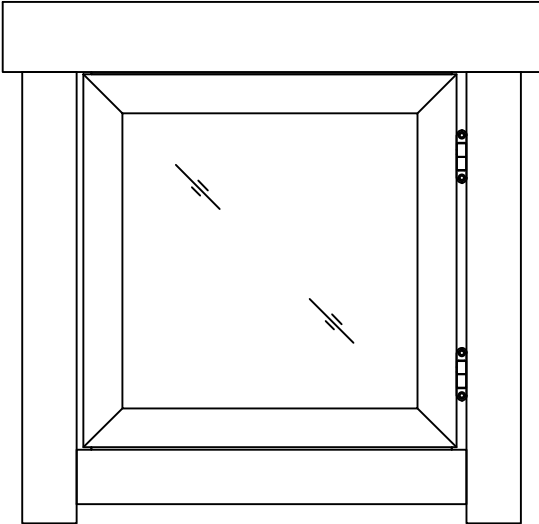
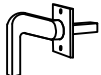
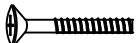

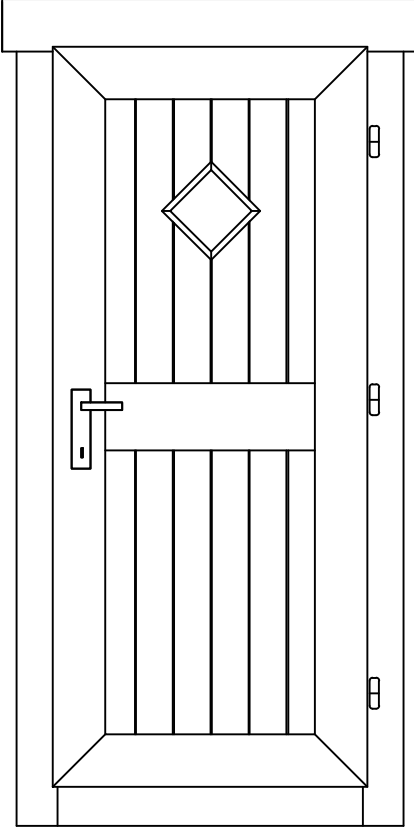
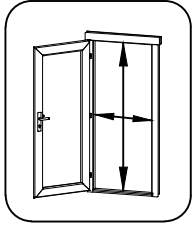
Pos	Piece list - Stückliste - Liste des pièces - Elementi - Stuklijst - Tükítabel 03.02.2018 Art.Nr. 284700	6/8	Q	P (mm)	L (mm)
001			2	28x57	834
002			8	28x114	228
003			4	28x114	228
004			30	28x114	834
005			2	28x57	834
006			2	28x57	2350
012			26	28x114	2350
013			4	28x114	3100
014			2	28x114	3100
015			2	28x114	2750
016			1	28x120	3300
017			10	28x114	889
018			1	28x120	3300
W2-1			1		
W3-1			1		
IAR1	Foundation - Fundament - Fondation - Fondamenta - Fundering - Immutatud alusraam 		2	45x45	2890
IAR2	Foundation - Fundament - Fondation - Fondamenta - Fundering - Immutatud alusraam 		8	45x45	2050
A-PR1	Roof beam - Dachbalken - Panne de toit - Perlina del tetto - Gordingen / dakbalk - Pärilin 		1	44x120	3300
	Floor boards - Fussbodenbretter - Lame de plancher - Pavimento - Vloerhout - Põrandalaud 		24	90x18	2090
	Terrace boards - Terrassenbretter - Plancher de terrasse - Piattaforme terrazzo - Terrasvloer - Terrassilaud 		22	90x19	718
	Roof boards - Dachbretter - Voliges - Perlina per tetto - Dakhout - Katuselaud 		74	90x18	1500
	Floor fillet - Fussbodenteiste - Corniere de finition du plancher - Finitura per pavimento (battisco pa) - Vloerafwerklijst - Põrandaliist 			18x18	8.36
	Roofing felt fillet - Dachpappenleiste - Baguette de fixation du feutre bitumeux - Asse per fissaggio guaina bituminosa - Afdekljst asfaltpapier - Katusepapiliist 		4	18x58	1550

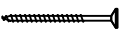
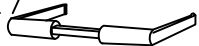
Pos	Piece list - Stückliste - Liste des pièces - Elementi - Stuklijst - Tükitalabel 03.02.2018 Art.Nr. 284700 7/8	Q	P (mm)	L (mm)
L4	Roof support - Dach träger - Support de toit - Supporto del tetto - Dak ondersteuning - Katusetugi 	1	18x90	552
L5	Roof support - Dach träger - Support de toit - Supporto del tetto - Dak ondersteuning - Katusetugi 	2	18x90	574
L6	Roof support - Dach träger - Support de toit - Supporto del tetto - Dak ondersteuning - Katusetugi 	1	18x90	2094
TB-1	Fascia board - Traufbrett - Bandeau de toit - Finitura lati tetto - Gevellijst Räästalaud 	2	18x58	3300
DRV-1	Roof edge reinforcement - Dachrandverstärkung - Corniere de renfort de bord de toit - Rinforzo x tetto - Dakrand versterking - Räästatugevdus 	2	28x34	3300
	Terrace edge board - Terrassenbrett, eingang - Lame de seuil d'entree de terrasse - Terrazzo uso abitacolo - Terrasvloer dorpel - Terrassi servaliist 	1	19x28	680
P1	Post - Pfosten - Poteau - Piede registrabile - Stijl - Post 	2	44x44	980
L1	Guard-rail for terrace - Terrassengeländer - Main courante de terrasse - Guardrail per terrazzo - Terras leuning - Terrassi äärelaud 	2	18x90	588
L2	Guard-rail for terrace - Terrassengeländer - Main courante de terrasse - Guardrail per terrazzo - Terras leuning - Terrassi äärelaud 	2	18x90	853
KFS-1	Storm protection - Sturmleiste - Latte anti-tempete - Protezione anti vento - Stormverankering / beveliging - Tormikinnitusliist 	4	22x45	2050
L3	U-profile - U-profils - Profile u - Profilo ad u - U-profiel - U-profiil 	2	28x58	537
GL	Gable moulding - Giebelleiste - Planche de rive - Finitura per frontale e retro del tetto - Gevellijst - Viilulaud 	4	18x90	1550
HS8	Screw for gable segment - Schrauben für deckblatt - Vis pour fixation losange de finition - Viti x frontali tetto - Schroef voor gevelpunt segment - Kruvi rombile 	4	3.5x35	
SC2	Screw for gable moulding - Schrauben für giebelleiste - Vis pour fixation planche de rive - Vite per fissare finiture davanti e dietro del tetto - Schroef voor gevellijst - Kruvi viilulauale 	16	3.5x50	
HS5	Screw for post - Schrauben für pfosten - Vis de fixation des poteaux - Viti per inviare - Schroef voor stijlen - Kruvi postile 	12	3x35	
HS14	Screw for u-profile - Schraube zur befestigung u-profils - Vis a tete fraisée pour profil u - Vite per profilo ad u - Schroef ter bevestiging u-profiel - Kruvi U-profiilile 	4	4.5x80	
HS12	Screw for fascia boards - Schrauben für traufbretter - Vis pour fixation bandeau de toit - Viti x striscia del tetto - Schroef voor gevellijst - Kruvi räästalauale 	16	4x40	
HS12	Screw for roof edge reinforcement - Schrauben für dachrandverstärkung - Vis pour fixation corniere renfort de bord de toit - Viti x rinforzo bordo tetto - Schroef voor dakrand versterking - Kruvi räästatugevdusele 	16	4x40	
HS12	Screws for terrace edge board - Schrauben für terrassenbrett - Vis de fixation de lame de seuil d'entree de terrasse - Vite per unire delle assi del terrazzo - Schroeven voor terrashout - Kruvi terrassi servaliistule 	3	4x40	
HS12	Screw for terrace rear boards - Schrauben für terrassenrand - Vis de fixation pour main courante de terrasse - Vite per il piano posteriore della terrazza - Schroef voor terras afsluitplint (achterzijde) - Kruvi terrassi äärelauale 	10	4x40	
SC1	Screw for post - Schrauben für pfosten - Vis de fixation des poteaux - Viti per inviare - Schroef voor stijlen - Kruvi postile 	12	4x60	
HS18	Screw for gable - Schrauben für giebel - Vis pour fixation des pignons - Viti per timpano - Schroef voor gevelpunt - Kruvi kelba kinnitamiseks 	4	5x120	
HS18	Screw for roof beams - Schrauben für dachbalken - Vis pour fixation pannes de toit - Viti per perline del tetto - Schroef voor gordingen / dakbalken - Kruvi pärlinitele 	2	5x120	

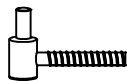
Pos	08.06.2015 Piece list - Stückliste - Liste des pièces - Elementi - Stuklijst - Tükítabel 564x540 AK.1.100.SVP.I SGC	1/1	Q	P (mm)	L (mm)
	<p data-bbox="260 152 1284 185">Glass size - Glasgröße - Taille de la vitre - Misura del vetro - Glas afmeting - Klaasi mõõt: 396x396 mm</p> <div data-bbox="1337 152 1522 327" style="border: 1px solid black; border-radius: 10px; padding: 5px; display: inline-block;">  </div> <p data-bbox="1366 349 1490 376" style="text-align: center;">464x464 mm</p> <div data-bbox="625 434 1166 956" style="text-align: center;">  </div>				
FS	<p data-bbox="260 2040 1023 2096">Window handle fittings - Fenstergriff - Poignee de fenetre - Maniglia c/ferramenta - Raamhendel -/grendel -/klink - Aknalink</p>		1		
FSP	<p data-bbox="260 2119 1102 2197">Bolt for window handle fittings - Bolzen für fenstergriff beschlag - Vis pour fixation poignee de fenetre - Bullone x apertura manuale finestra - Schroef voor raamhendel - Akna käepideme polt</p>		2		

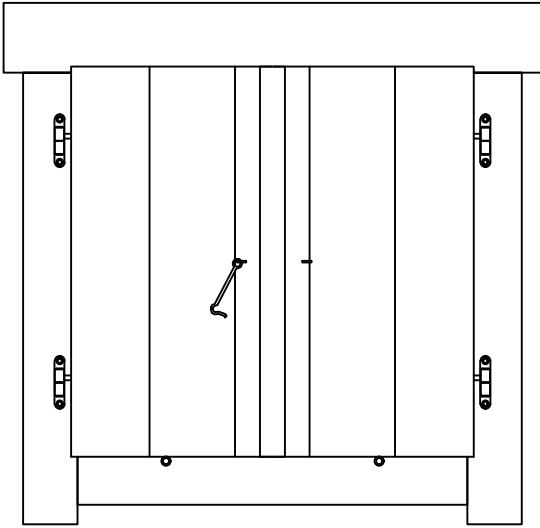
Pos	04.08.2014 Piece list - Stückliste - Liste des pièces - Elementi - Stuklijst - Tükítabel 674x1450 UK.2.020.SVP.b. SGC	1/1	Q	P (mm)	L (mm)
	<p>Glass size - Glasgröße - Taille de la vitre - Misura del vetro - Glas afmeting - Klaasi mõõt: 160x160 mm</p>   <p>574x1350 mm</p>				
HS16	Screw for door jamb - Schraube für Türrahmen - Vis de fixation partie haute avec montants du cadre de porte - Viti x fissaggio montanti porte - Schroef voor deurkozijn - Kruvi ukse lengile		4	5x90	
HS25	Screw for doorstep - Schrauben für swelle - Vis pour fixation barre de seuil - Vite per soglia della porta - Schroef voor deurdorpel - Kruvi lävepakule		2	5x90	
TL4	Door handle fittings - Türgriff - Poignée de porte - Maniglie - Deurhendel / klink - Ukse käepide VU		1		
TL5	Set of door lock covers - Schlossblenden - Set de garnitures de porte - Copertura serrature - Slot sluitplaat set - Ukse lukuplaat		1		
	Cylinder lock - Zylinderschloss - Barillet de porte - Serratura - Cylinder slot - Ukse lukusüdamik		1	30x35	
	Male bolt hinge for door - Türband - Partie male de paumelle de porte - Cerniera anube x porta - Scharnier bout - Ukse polthing isane		3		

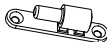
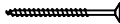
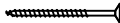
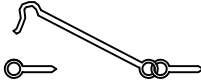
Pos	Piece list - Stückliste - Liste des pièces - Elementi - Stuklijst - Tükitabel 15.11.2012 Shutters 564x540- Fensterläden 564x540 - Volets de fenetre 564x540 - Alconi o persiane 564x540 - Luiken 564x540 - Aknaluuk 564x540	1/1	Q	P (mm)	L (mm)
					
1	Hinge for shutters - Scharnier für fensterläden - Charniere pour volets - Cerniere per balconi - Raamluik scharnier - Akna polthing emane		4	D13x68	
2	Hinge for shutters - Scharnier für fensterläden - Charniere pour volets - Cerniere per balconi - Raamluik scharnier - Akna polthing isane		4	D13x68	
3	Screw for shutter hinge - Schraube für fensterläden scharnier - Vis pour shutter charniere - Viti per cerniera a battente - Schroef voor luiken scharnier - Kruvi akna polthingele		8	4x40	
4	Screw for shutters fillet - Schraube zur befestigung fensterlädenleiste - Vis d'assemblage du cadre de volets de fenetre - Viti per massellino dei balconi - Schroef voor bevestiging lijstwerk luiken - Kruvi luugi kokkuvalltsiliistule		2	3x30	
5	Shutter hook - Feststeller fensterläden - Arrêts de vents pour volets - Gancio dell'otturatore - Luiken vergrendeling - Luugihaak		3	60	

Pos	06.05.2013	Piece list - Stückliste - Liste des pièces - Elementi - Stuklijst - Tükítabel Art.Nr. 991200	1/1	Q	P (mm)	L (mm)
-----	------------	---	-----	---	-----------	-----------

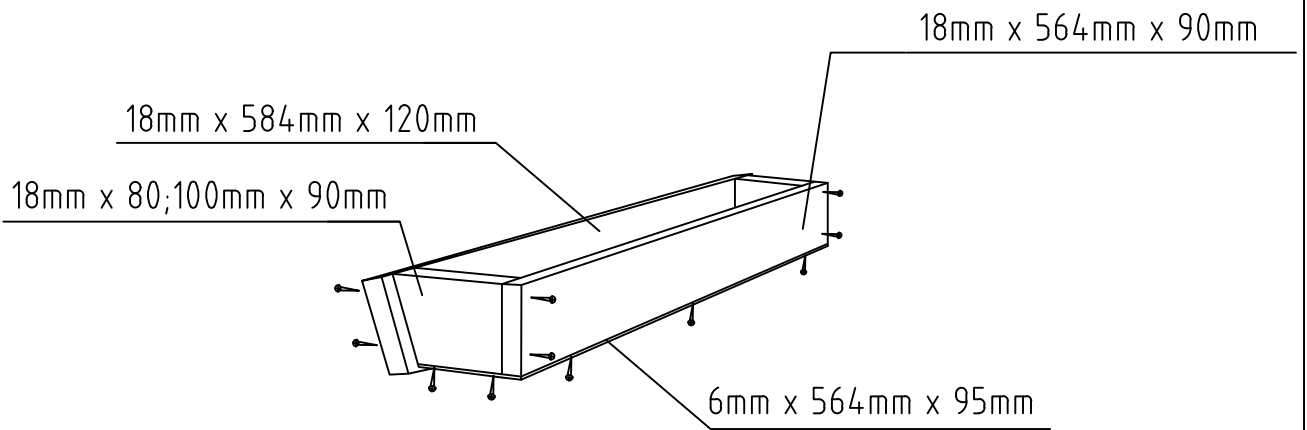

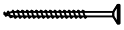
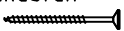
HS9	Screw for flower box - Montagschraube für blumentasten - Vis d'assemblage des jardinières - Viti per fioriera - Montageschroeven voor bloembak - Kruvi lillekasti montaažiks		18	3.5x50	
HS12	Screw for fixing flower box to the walls - Schraube zur Befestigung den Blumenkasten - Vis de fixation au mur des jardinières - Viti per fissare la fioriera alle pareti - Schroeven voor bevestiging bloembak met wand - Kruvi lillekasti kinnitamiseks seinale		2	4x40	